

CATALOGUE

2024



KROSS

YOU CAN DO EVERYTHING



DUE TO THE COMPLEX NATURE OF THE MANUFACTURING PROCESS AND VARIABLE CONDITIONS OF COMPONENT DELIVERY, TECHNICAL SPECIFICATIONS ARE SUBJECT TO CHANGEDURING THE SEASON. SPECIFICATIONS PRESENTED HERE IN ARE VALID AS OF THE DATE OF PUBLICATION, THAT IS SEPTEMBER 2023. INFORMATION INCLUDED IN THE CATALOGUE SHALL NOT CONSTITUTE AN OFFER, AS DEFINED IN ART. 66 § 1 OF THE POLISH CIVIL CODE.

FOR THE LATEST OFFER, INCLUDING PRODUCT SPECIFICATIONS, VISIT WWW.KROSS.EU

VERSION 1.0

WE ARE OPENING A NEW SEASON!

In 2024 we are reinforcing our sporting 'DNA' with a focus on gravel, MTB and road bikes, but we are not forgetting urban and leisure bikes. In line with global trends, we are developing electric bikes in almost all categories. Because of this, and due to a wide range of parts and accessories, we cover the needs of all cyclists.

Looking at the prospects for the development of the bicycle market and aware of our own competence, full of passion and optimism, we keep on riding!

We invite you to ride with us!



CONTENTS:

» KROSS WORLD	6
» KROSS IS SPORT	12
» BIKES	16
- Gravel / Esker	18
- Road / Vento	54
- MTB / Earth / Level / Hexagon / Lea	66
- Trekking / Trans	148
- Cross / Evado.....	168
- City / Sentio / Le Grand Lille.....	190
- E-MTB FS / Moon Boost / Soil Boost / Grist Boost	202
- E-SUV / Grist Boost SUV.....	210
- E-MTB HT / Level Boost / Hexagon Boost / Lea Boost	212
- E-Trekking / Trans Hybrid / Trans Hybrid LS	230
- E-Cross / Evado Hybrid.....	246
- E-City / Sentio Hybrid / Le Grand eLille / Inzai Hybrid.....	256
- E-cargo / Business / Platform / Family.....	276
- Kids / Level Jr / Dust Jr / Hexagon Jr / Lea Jr / Level Mini / Hexagon Mini / Lea Mini / Mini / Racer	284
» APPAREL	312
» ACCESSORIES	373
» COMPONENTS	459



CATEGORY MARKINGS



Esker bicycles were designed for exploration and discovery.



Recreational and sport MTB bikes powered by your own strength and electrically assisted.



Have fun with speed and enjoy freedom with Vento road bikes.



Explore and discover nature with comfort with the Trans and Trans Hybrid series.

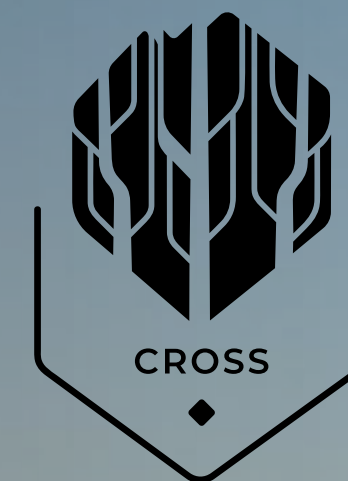

Taste the speed and enjoy driving versatility in any terrain.



Enjoy independence and venture into the city with Sentio and Le Grand urban bikes.



Avoid traffic jams and navigate in the city efficiently while transporting children or groceries.



KROSS WORLD

WHO ARE WE? OF EXPERIENCE AND COMMITMENT

We are a Polish family-run company based in the same place - Przasnysz - for almost 35 years. We started as a small shop, and commitment and listening to the needs of cyclists led us to the position of a leader - the largest manufacturer of bicycles in Poland, a brand present in over 50 countries worldwide.

But we are not resting on our laurels and are constantly investing our knowledge and passion into the future of the world of cycling: developing our Research & Development team (consisting of the best engineers, designers, enthusiasts and professional riders), investing in responsible production in our factory in Przasnysz and constantly improving our bikes.

Due to our responsibility for all stages of the creation of a bike - from designing, through meticulous testing, selection of components to painting and production in Poland, we are sure that our customers receive the best product.

We are also constantly monitoring the world around us and reacting to how our lives are changing. This is why we have been dynamically developing the family of electric bicycles (e-BIKE) over the last few years, seeing that they are becoming an important part of electromobility.

THANK YOU FOR BEING WITH US!



The design team creates a paint scheme in line with the latest global trends and market expectations

Carbon frames are manufactured at the KROSS factory in Poland

A team of more than a dozen engineers designs bicycle frames

The bikes are manufactured to the highest standards at the KROSS factory in Poland

All frames are painted at the KROSS factory in Poland

We test all KROSS bicycles in our own testing laboratory as well as during rigorous field tests





YOU CAN DO EVERYTHING **MANIFESTO**

The strength of the KROSS brand is the passion that accompanies the creation of bicycles backed up by over 30 years of expertise.

Our new communication focuses on progressiveness, modernity on a par with the excitement of those for whom a bicycle is more than just a fun once-a-month or once-a-year activity.

It is a passion that accompanies us all the time. Regardless of where we are. And who we are.

Because to experience the emotions that KROSS provides, you don't need much. You just need to love the bike. And then the magic begins.

The embodiment of this idea is our slogan:

YOU DON'T HAVE TO DO ANYTHING. YOU CAN DO EVERYTHING.

Thanks to this, KROSS arouses energy and motivates action. For all. Whether you live in the countryside or in a city, whether you are a child or a mature person. The bicycle is an important part of your life.



YOU DON'T HAVE TO DO ANYTHING. YOU CAN DO EVERYTHING

DYNAMICS / KROSS was born out of a desire to be better, a need to be constantly on the move.

From a passion for cycling, which allows us to live a better, more exciting, healthier and fuller life every day.

And we have turned our passion into one of the most innovative brands in Europe. To inspire others with it.

To make everyone feel that that they can do everything. If they only want to.

We believe that excellence is a process and that deriving joy from simply striving to be better is possible.

CHALLENGES / The pursuit of becoming better means discovering oneself, one's limits, and continuously exploring new possibilities - constantly challenging oneself.

Every expedition, rally, downhill ride, or ride on an unknown route is a new experience and a new test.

KROSS gives the impulse to embrace them and, through this, leads to positive changes in life.

YOU DON'T HAVE TO DO ANYTHING. YOU CAN DO EVERYTHING

KROSS is not just for athletes. Superheroes.

We ourselves are regular people who have our own passion, but also deal with common weaknesses, a busy schedule, and important matters.

We ride, we take on challenges, we work on ourselves because we can and we want to. We feel that this is good for us. Not because we have to. KROSS is the freedom to take on challenges.

We know from experience that every challenge we take on is accompanied by the joy and satisfaction that riding brings. Regardless of how much we tire ourselves out in the process.

Cycling is simply about excitement. Detached from screens, notifications and other distractions. With a focus on oneself, one's aspirations, and feelings. Every trip with KROSS is a new adventure.

At the end of the day, what drives the KROSS brand and its customers is pure passion for cycling. The desire to get on two wheels, ride more kilometres, conquer another mountain, see unexplored places, and challenge oneself in new ways.

/ FREEDOM

/ ADVENTURE

/ PASSION





KROSS IS SPORT

BORN FROM A PASSION FOR SPORT

Sport propels us into action.

We know that cycling is not just about racing and winning trophies on Strava. It's also about spending time with loved ones, daily commutes to work, and taking care of our health.

By understanding consumers' passions and needs, we create and provide products dedicated to people with different levels of advancement.

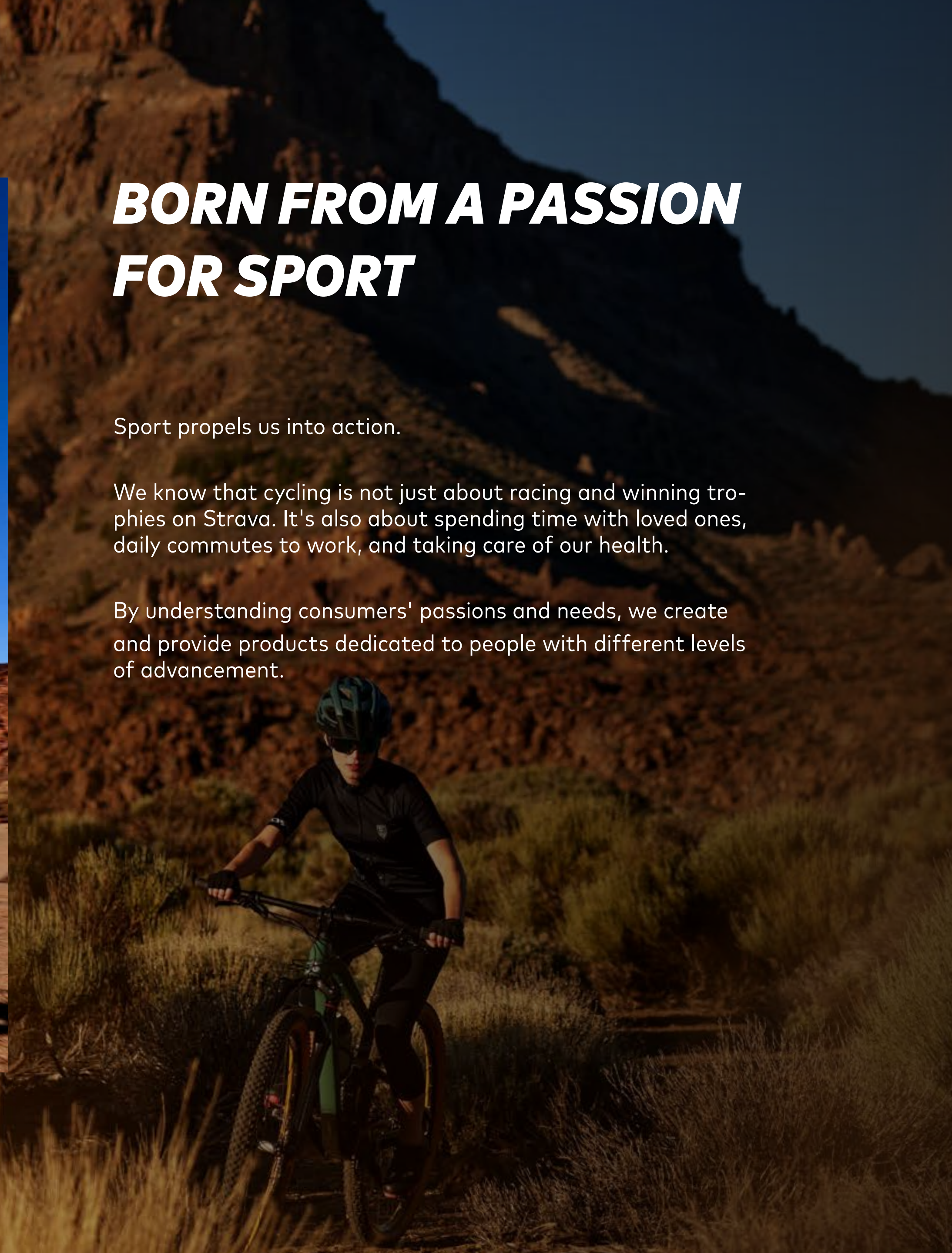

THE ARCHITECTURE OF SEGMENTS COVERS ALL CONSUMER NEEDS

DIRECTIONS 2024/2026



PORTFOLIO DEVELOPMENT

QUANTITATIVE AND QUALITATIVE APPROACH

We cover our clients' needs comprehensively.

The portfolio focuses on sports bikes and electric bicycles.

Mass-produced products are well-taken care of and we have a wide range of them.



ON THE KROSS DATABASE



BIKES



GRAVEL BIKES

ESKER

More than just a bicycle. A lifestyle that combines passion, a desire to explore new routes, a spirit of adventure and challenge, and the opportunity to spend time among like-minded enthusiasts.

It is not only a form of sport, but also an opportunity to bond with the cycling community and enjoy the pleasure of riding on two wheels in beautiful natural scenery.





ESKER RS

THE FASTEST IN THE CATEGORY

KROSS Esker RS is an advanced gravel bike, which was developed with the aim of competing at the highest level in gravel races. This is our the most innovative sport gravel bike.

Aerodynamic design: frame, fork and seatpost of the Esker RS bicycle were specially designed in collaboration with the Łukasiewicz Research Network – Institute of Aviation in Warsaw, to minimize air resistance.

Adjustable geometry: thanks to the flip chip you can optimize geometry to your riding style.

Top components: designed for racing.



ESKER RS

CREATED IN COLLABORATION WITH
THE ŁUKASIEWICZ RESEARCH NETWORK – INSTITUTE OF AVIATION

- » Air resistance minimization.
- » Integration of the frame and other components.
- » Specially created aerodynamic profiles.



ESKER RS

DIFFERENTIATORS AND ADVANTAGES

Dedicated aerodynamic seatpost

Integrated seatpost clamp

700 x 47C tire

„Flip-chip“: adjustable frame geometry settings

Cable housing routing to ICR system standard and integrated cockpit

Aero frame

Aerodynamic fork

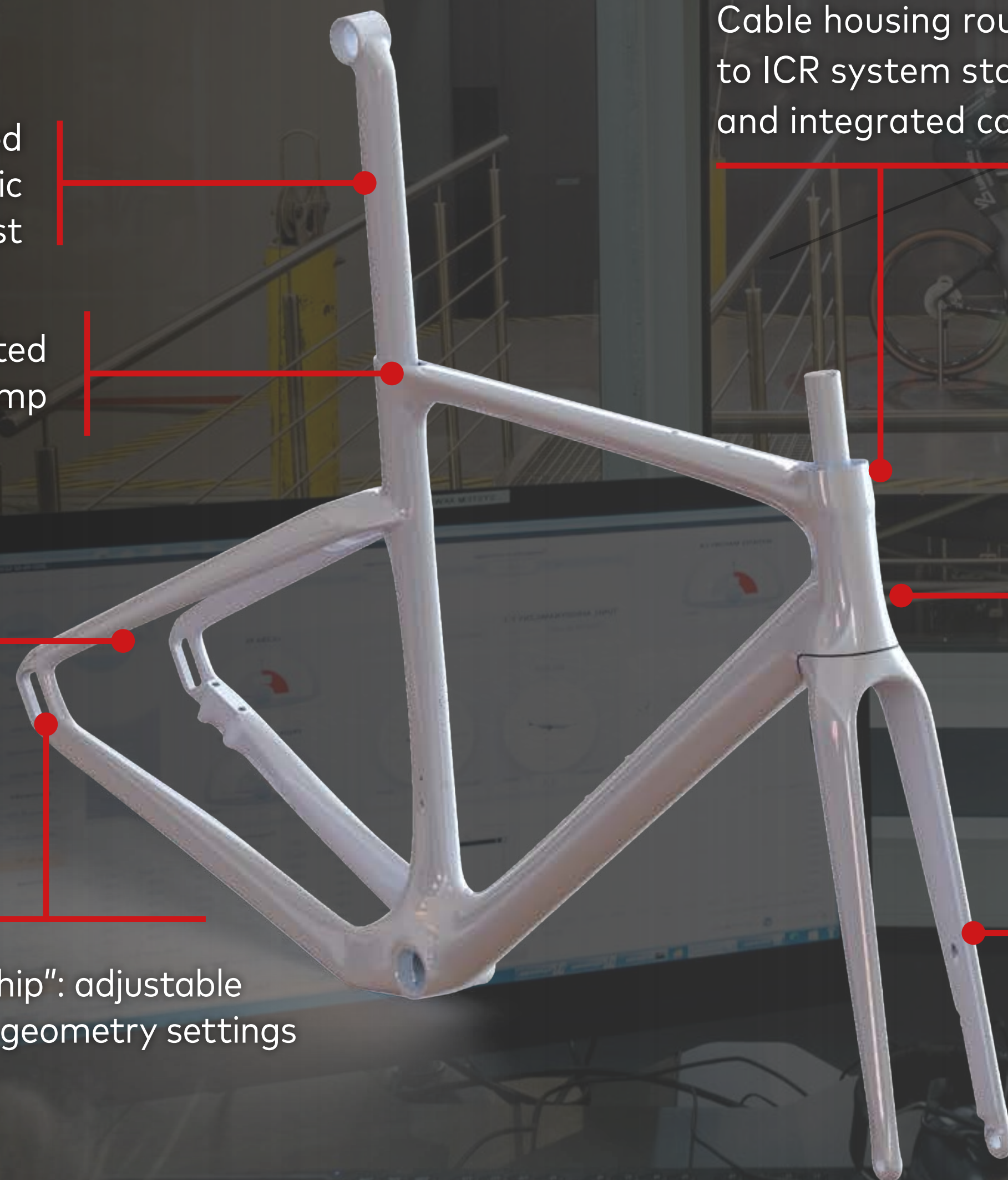

ESKER RS

ADJUSTABLE FRAME GEOMETRY "FLIP-CHIP"



Thanks to the variable frame element - "Flip-chip" it is possible to choose one of two geometries

POSITION „HIGH”

CS – 415 mm
WB – 1005 mm
REACH – 384 mm
ST ANGLE – 74,3°
HT ANGLE – 71,1°
STACK – 564 mm
BB DROP – 73,5 mm

POSITION „LOW”

CS – 425 mm
WB – 1015 mm
REACH – 378 mm
ST ANGLE – 73,7°
HT ANGLE – 70,5°
STACK – 569 mm
BB DROP – 80 mm

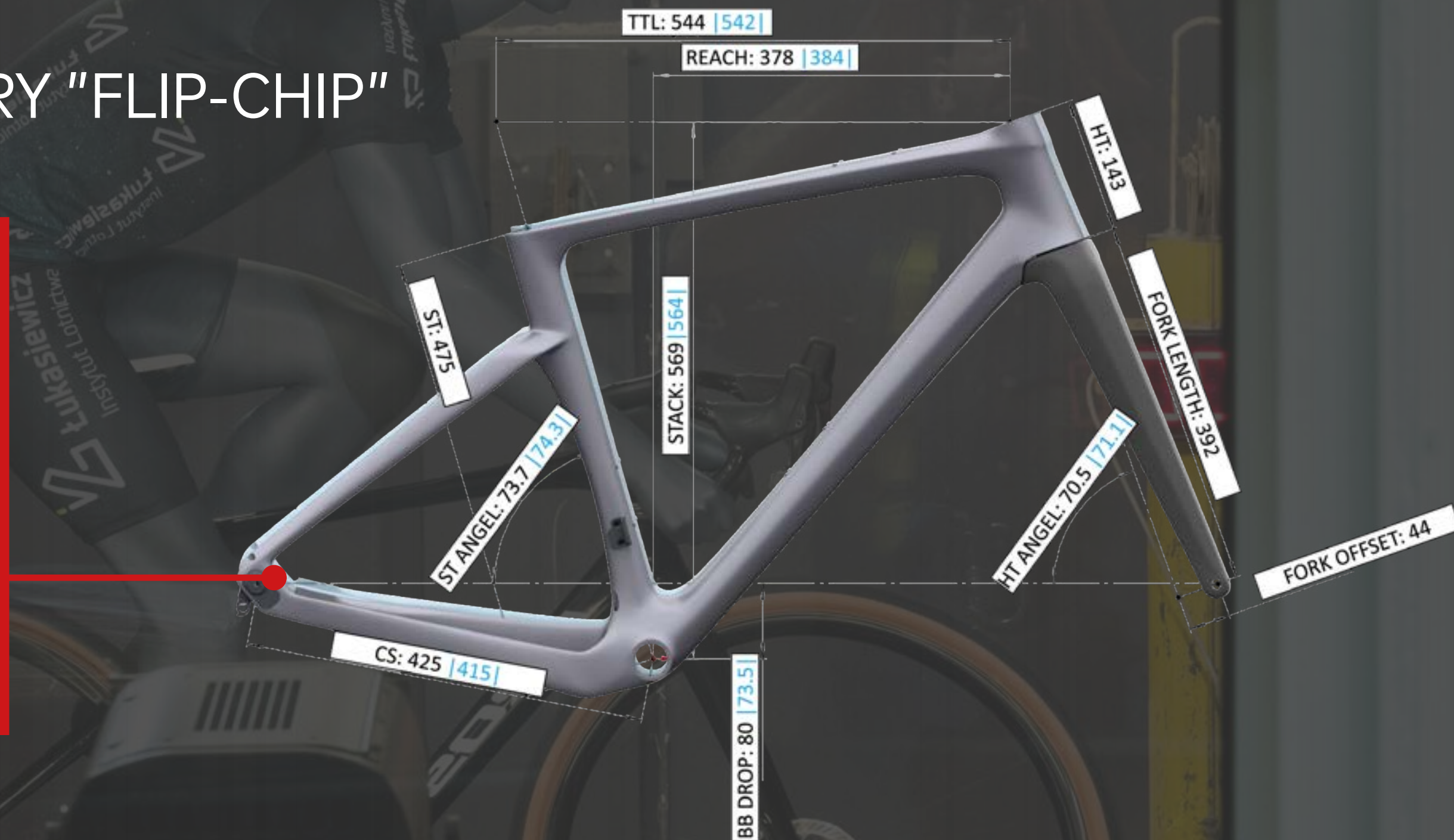

ESKER RS 3.0

NEW



SKU	SIZE	COLOUR	FINISH
KRRR3Z28X18M006692	S	green	gloss
KRRR3Z28X19M006693	M	green	gloss
KRRR3Z28X20M006694	L	green	gloss
KRRR3Z28X21M006695	XL	green	gloss
KRRR3Z28X18M007149	S	brown	gloss
KRRR3Z28X19M007150	M	brown	gloss
KRRR3Z28X20M007151	L	brown	gloss
KRRR3Z28X21M007152	XL	brown	gloss

GEAR RATIO 1 x 12
WHEEL DIAMETER 700C
COLOUR VARIANTS



FRAME

FRAME	CARBON
FORK	CARBON
SIZES	S(18"), M(19"), L(20"), XL(21")

DRIVETRAIN

REAR DERAILLEUR	SRAM RIVAL XPLR
FRONT BRAKE	SRAM RIVAL
REAR BRAKE	SRAM RIVAL
BRAKE LEVERS	SRAM RIVAL
BRAKE DISCS	SRAM CENTERLINE 160 mm CL
SHIFTERS	SRAM RIVAL
CRANKSET	SRAM RIVAL
SPROCKETS	40T/170 mm
BOTTOM BRACKET	SRAM RIVAL
CHAIN	SRAM RIVAL D1
CASSETTE/FREEWHEEL	SRAM XG
CASSETTE/FREEWHEEL RANGE	10-44T

WHEELS

FRONT HUB	FSA SL-K 12 x 100
REAR HUB	FSA SL-K 12 x 142
RIMS	FSA SL-K CARBON i 25
TIRES	SCHWALBE G-ONE 28 x 1,7

COMPONENTS

HANDLEBAR	FSA A-WING PRO 420 mm 31.8
HANDLEBAR STEM	FSA NS ACR STEM 80 mm/31,8/-6°
SEAT POST	CARBON
HEADSET	FSA ACR NO.55R 1.5"/ACR/STD
SADDLE	FIZIK TERRA ARGO X5
GRIPS	FIZIK TERRA MICROTEx

GEOMETRY

SIZE	S	M	L	XL
FS - FRAME SIZE*	18	19	20	21
ST - SEAT TUBE LENGTH**	453	476	514	543
TT - TOP TUBE LENGTH**	527	544	560	592
HT - HEAD TUBE LENGTH**	123	143	172	206
SA - SEAT TUBE ANGLE***	74	74	74	73
HA - HEAD TUBE ANGLE***	69	71	71	71
CS - CHAINSTAY LENGTH**	425	425	425	425
WB - WHEELBASE**	368	378	385	400
REACH**	546	569	598	627
STACK**	1007	1015	1029	1053
BB DROP**	80	80	80	75

* dimension in inches, ** dimension in mm, *** dimension in degrees

ESKER RS 2.0

NEW



SKU	SIZE	COLOUR	FINISH
KRRR2Z28X18M006688	S	gray	gloss
KRRR2Z28X19M006689	M	gray	gloss
KRRR2Z28X20M006690	L	gray	gloss
KRRR2Z28X21M006691	XL	gray	gloss
KRRR2Z28X18M007145	S	blue	gloss
KRRR2Z28X19M007146	M	blue	gloss
KRRR2Z28X20M007147	L	blue	gloss
KRRR2Z28X21M007148	XL	blue	gloss

GEAR RATIO 1 x 12
WHEEL DIAMETER 700C
COLOUR VARIANTS



FRAME

FRAME	CARBON
FORK	CARBON
SIZES	S(18"), M(19"), L(20"), XL(21")

DRIVETRAIN

REAR DERAILLEUR	SRAM APEX XPLR AXS
FRONT BRAKE	SRAM APEX
REAR BRAKE	SRAM APEX
BRAKE LEVERS	SRAM APEX
BRAKE DISCS	SRAM CENTERLINE 160 mm CL
SHIFTERS	SRAM APEX
CRANKSET	SRAM APEX
SPROCKETS	40T/170 mm
BOTTOM BRACKET	SRAM BSA DUB
CHAIN	SRAM APEX D1
CASSETTE/FREEWHEEL	SRAM NX EAGLE
CASSETTE/FREEWHEEL RANGE	11-44T

WHEELS

FRONT HUB	DT SWISS 370 12 x 100
REAR HUB	DT SWISS 370 12 x 142
RIMS	DT SWISS G1800
TIRES	SCHWALBE G-ONE 28X1,7

COMPONENTS

HANDLEBAR	FSA A-WING PRO 420 mm 31.8
HANDLEBAR STEM	FSA NS ACR STEM 80 mm/31,8/-6°
SEAT POST	CARBON
HEADSET	FSA ACR NO.55R 1.5"/ACR/STD
SADDLE	FIZIK TERRA ARGO X5
GRIPS	FIZIK TERRA MICROTEx

GEOMETRY

SIZE	S	M	L	XL
FS - FRAME SIZE*	18	19	20	21
ST - SEAT TUBE LENGTH**	453	476	514	543
TT - TOP TUBE LENGTH**	527	544	560	592
HT - HEAD TUBE LENGTH**	123	143	172	206
SA - SEAT TUBE ANGLE***	74	74	74	73
HA - HEAD TUBE ANGLE***	69	71	71	71
CS - CHAINSTAY LENGTH**	425	425	425	425
WB - WHEELBASE**	368	378	385	400
REACH**	546	569	598	627
STACK**	1007	1015	1029	1053
BB DROP**	80	80	80	75

* dimension in inches, ** dimension in mm, *** dimension in degrees

ESKER RS 1.0

NEW



SKU	SIZE	COLOUR	FINISH
KRRR1Z28X18M006684	S	gray	gloss
KRRR1Z28X19M006685	M	gray	gloss
KRRR1Z28X20M006686	L	gray	gloss
KRRR1Z28X21M006687	XL	gray	gloss
KRRR1Z28X18M007141	S	navy	gloss
KRRR1Z28X19M007142	M	navy	gloss
KRRR1Z28X20M007143	L	navy	gloss
KRRR1Z28X21M007144	XL	navy	gloss

GEAR RATIO 1 x 12
WHEEL DIAMETER 700C
COLOUR VARIANTS



FRAME

FRAME	CARBON
FORK	CARBON
SIZES	S(18"), M(19"), L(20"), XL(21")

DRIVETRAIN

REAR DERAILLEUR	SHIMANO GRX RD-RX822
FRONT BRAKE	SHIMANO GRX RX410
REAR BRAKE	SHIMANO GRX RX410
BRAKE LEVERS	SHIMANO GRX RX610
BRAKE DISCS	SHIMANO RT80 ICE TECH 160 mm CL
SHIFTERS	SHIMANO GRX RX610
CRANKSET	SHIMANO FC-RX610 GRX
SPROCKETS	40T/172,5 mm
BOTTOM BRACKET	SHIMANO GRX
CHAIN	SHIMANO M7100
CASSETTE/FREEWHEEL	SHIMANO SLX M7100
CASSETTE/FREEWHEEL RANGE	10-45T

WHEELS

FRONT HUB	DT SWISS 370 12 x 100
REAR HUB	DT SWISS 370 12 x 142
RIMS	DT SWISS G1800 25 mm
TIRES	WTB BYWAY 28X1.625

COMPONENTS

HANDLEBAR	FSA A-WING PRO 420 mm 31.8
HANDLEBAR STEM	FSA NS ACR STEM 80 mm/31,8/-6°
SEAT POST	CARBON
HEADSET	ACR NO.55R 1.5"/ACR/STD
SADDLE	FIZIK TERRA ARGO X5
GRIPS	FIZIK TERRA MICROTEX

GEOMETRY

SIZE	S	M	L	XL
FS - FRAME SIZE*	18	19	20	21
ST - SEAT TUBE LENGTH**	453	476	514	543
TT - TOP TUBE LENGTH**	527	544	560	592
HT - HEAD TUBE LENGTH**	123	143	172	206
SA - SEAT TUBE ANGLE***	74	74	74	73
HA - HEAD TUBE ANGLE***	69	71	71	71
CS - CHAINSTAY LENGTH**	425	425	425	425
WB - WHEELBASE**	368	378	385	400
REACH**	546	569	598	627
STACK**	1007	1015	1029	1053
BB DROP**	80	80	80	75

* dimension in inches, ** dimension in mm, *** dimension in degrees



GRAVEL ADVENTURE

Esker 8.0 and Esker 7.0 are versatile models with a carbon frame, designed for exploring new terrains and routes beyond paved roads.

Multifunctionality: Esker 8.0 and Esker 7.0 have been designed to excel on various surfaces and distances.

Durable frame: carbon fibre provides a balance between low weight and structural strength, and riding comfort.

Stable and comfortable geometry that ensures confident bike handling on various surfaces and provides comfort during long rides.

Compatible with accessories: the Esker 8.0 and Esker 7.0 can be equipped with carriers, mudguards and bags.

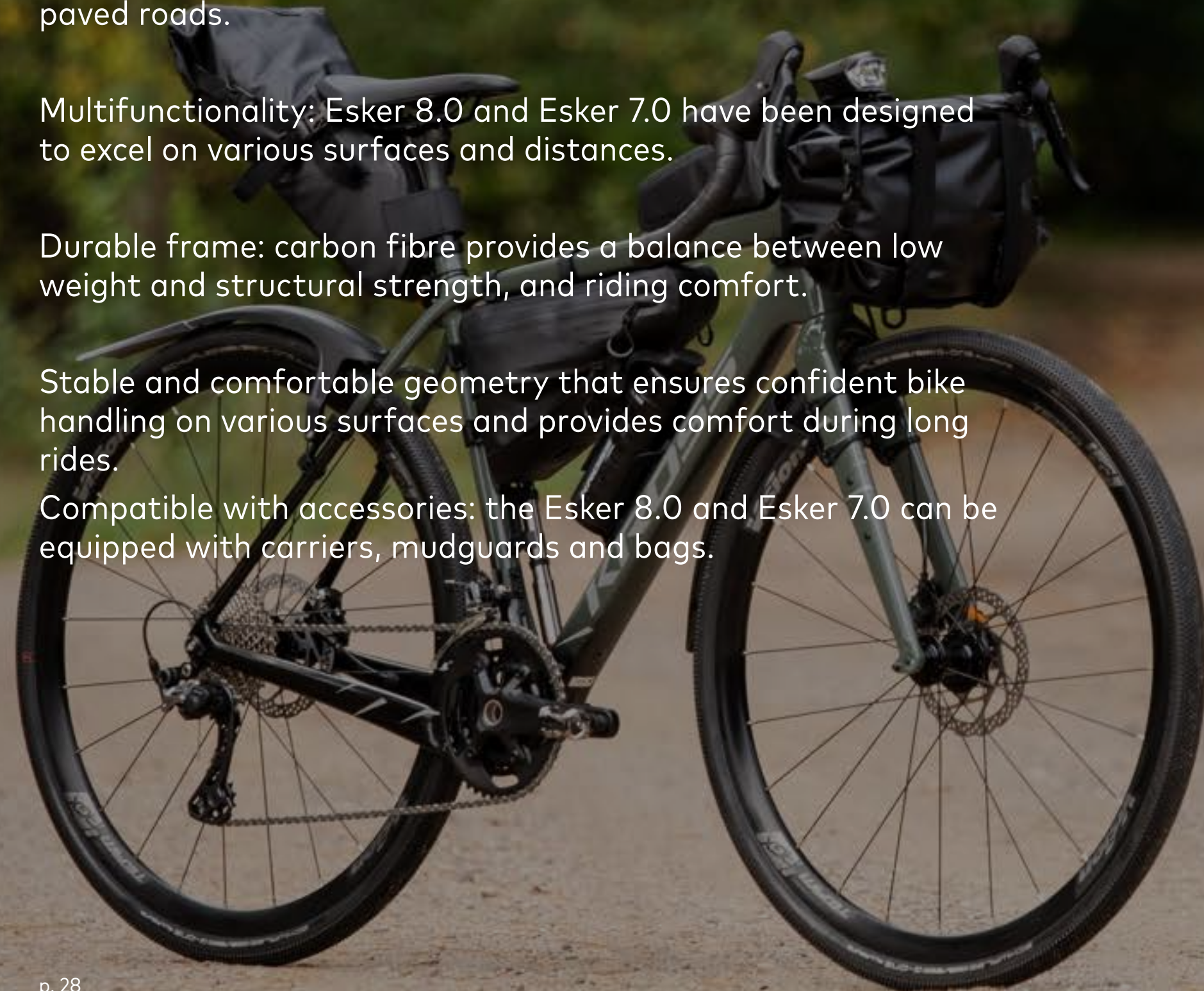

ESKER 8.0

NEW



SKU	SIZE	COLOUR	FINISH
KREK8Z28X19M006678	S	gray	gloss
KREK8Z28X20M006679	M	gray	gloss
KREK8Z28X21M006680	L	gray	gloss
KREK8Z28X22M006681	XL	gray	gloss
KREK8Z28X19M007430	S	green	gloss
KREK8Z28X20M007431	M	green	gloss
KREK8Z28X21M007432	L	green	gloss
KREK8Z28X22M007433	XL	green	gloss

GEAR RATIO 2 x 11
WHEEL DIAMETER 700C
COLOUR VARIANTS



FRAME

FRAME	CARBON
FORK	CARBON
SIZES	S(19"), M(20"), L(21"), XL(22")

DRIVETRAIN

FRONT DERAILLEUR	SHIMANO GRX RX810
REAR DERAILLEUR	SHIMANO GRX RX810
FRONT BRAKE	SHIMANO GRX RX400
REAR BRAKE	SHIMANO GRX RX400
BRAKE LEVERS	SHIMANO GRX RX600
BRAKE DISCS	SHIMANO RT30 160 mm CL
SHIFTERS	SHIMANO GRX RX600
CRANKSET	SHIMANO FC-RX600 GRX
SPROCKETS	46T-30T/170 mm
BOTTOM BRACKET	SHIMANO BSA BB-RS501
CHAIN	SHIMANO HG601
CASSETTE/FREEWHEEL	SHIMANO GRX RX600 HG700
CASSETTE/FREEWHEEL RANGE	11-34T

WHEELS

FRONT HUB	VISION TEAM 12 x 100
REAR HUB	VISION TEAM 12 x 100
RIMS	FSA TEAM AERO-GRAVEL I23 700C
TIRES	SCHWALBE G-ONE ALLRND 700 x 38C

COMPONENTS

HANDLEBAR	FSA K-WING AGX 420 mm 31.8
HANDLEBAR STEM	ALUMINIUM 80 mm/31,87°
SEAT POST	FSA KFX SBO 27,2 x 350 mm CARBON
HEADSET	FSA NO.42/ACB;1-1/8"-1,5"
SADDLE	FIZIK TERRA ARGO X5
GRIPS	FIZIK TERRA MICROTEx

GEOMETRY

SIZE	S	M	L	XL
FS - FRAME SIZE*	19	20	21	22
ST - SEAT TUBE LENGTH**	490	520	540	560
TT - TOP TUBE LENGTH**	520	535	550	565
HT - HEAD TUBE LENGTH**	120	140	150	170
SA - SEAT TUBE ANGLE***	74,5	74	73	73
HA - HEAD TUBE ANGLE***	70,5	71	71,5	72
CS - CHAINSTAY LENGTH**	435	435	435	435
WB - WHEELBASE**	1020	1027	1027	1037
REACH**	371	375	376	385
STACK**	537	557	568	590
BB DROP**	67	67	67	67

* dimension in inches, ** dimension in mm, *** dimension in degrees

ESKER 8.0



SKU	SIZE	COLOUR	FINISH
KREK8Z28X19M004368	S	green	gloss
KREK8Z28X20M004369	M	green	gloss
KREK8Z28X21M004370	L	green	gloss
KREK8Z28X22M004371	XL	green	gloss

GEAR RATIO 2 x 11

WHEEL DIAMETER 700C

COLOUR VARIANTS



FRAME

FRAME	CARBON T784
FORK	CARBON
SIZES	S(19"), M(20"), L(21"), XL(22")

DRIVETRAIN

FRONT DERAILLEUR	SHIMANO GRX RX810
REAR DERAILLEUR	SHIMANO GRX RX810
FRONT BRAKE	SHIMANO GRX RX400
REAR BRAKE	SHIMANO GRX RX400
BRAKE LEVERS	SHIMANO GRX RX600
BRAKE DISCS	SHIMANO RT30 (160 mm)
SHIFTERS	SHIMANO GRX RX600
CRANKSET	SHIMANO GRX RX600
SPROCKETS	46T-30T/170 mm
BOTTOM BRACKET	SHIMANO BSA BB-RS500
CHAIN	SHIMANO HG601
CASSETTE/FREEWHEEL	SHIMANO GRX RX600 HG700
CASSETTE/FREEWHEEL RANGE	11-34T

WHEELS

FRONT HUB	FSA TEAM 12 x 100
REAR HUB	FSA TEAM 12 x 142
RIMS	FSA TEAM AERO-GRAVEL I23 700C
TIRES	SCHWALBE G-ONE ALLRND 700 x 38C

COMPONENTS

HANDLEBAR	FSA K-WING AGX 420 mm 31.8
HANDLEBAR STEM	ALUMINIUM 80 mm/31,87°
SEAT POST	FSA KFX SBO 27,2 x 350 mm CARBON
HEADSET	FSA NO.42/ACB;1-1/8"-1,5"
SADDLE	FIZIK TERRA ARGO X5
GRIPS	FIZIK TERRA MICROTEX

GEOMETRY

SIZE	S	M	L	XL
FS - FRAME SIZE*	19	20	21	22
ST - SEAT TUBE LENGTH**	490	520	540	560
TT - TOP TUBE LENGTH**	520	535	550	565
HT - HEAD TUBE LENGTH**	120	140	150	170
SA - SEAT TUBE ANGLE***	74,5	74	73	73
HA - HEAD TUBE ANGLE***	70,5	71	71,5	72
CS - CHAINSTAY LENGTH**	435	435	435	435
WB - WHEELBASE**	1020	1027	1027	1037
REACH**	371	375	376	385
STACK**	537	557	568	590
BB DROP**	67	67	67	67

* dimension in inches, ** dimension in mm, *** dimension in degrees

ESKER 7.0

NEW



SKU	SIZE	COLOUR	FINISH
KREK7Z28X20M006675	M	orange	gloss
KREK7Z28X21M006676	L	orange	gloss
KREK7Z28X22M006677	XL	orange	gloss
KREK7Z28X19M007426	S	blue	gloss
KREK7Z28X20M007427	M	blue	gloss
KREK7Z28X21M007428	L	blue	gloss
KREK7Z28X22M007429	XL	blue	gloss

GEAR RATIO 1 x 11
WHEEL DIAMETER 700C
COLOUR VARIANTS



FRAME

FRAME	CARBON
FORK	CARBON
SIZES	S(19"), M(20"), L(21"), XL(22")

DRIVETRAIN

REAR DERAILLEUR	SHIMANO GRX RX812
FRONT BRAKE	SHIMANO GRX RX400
REAR BRAKE	SHIMANO GRX RX400
BRAKE LEVERS	SHIMANO GRX RX600
BRAKE DISCS	SHIMANO RT30 160 mm CL
SHIFTERS	SHIMANO GRX RX600
CRANKSET	SHIMANO FC-RX600 GRX
SPROCKETS	40T /170 mm
BOTTOM BRACKET	SHIMANO BSH BB-R5500
CHAIN	SHIMANO HG601
CASSETTE/FREEWHEEL	SHIMANO SLX M7000
CASSETTE/FREEWHEEL RANGE	11-42T

WHEELS

FRONT HUB	SHIMANO RS470 12 X 100
REAR HUB	SHIMANO RS470 12X 142
RIMS	DT SWISS G 540 622 x 24
TIRES	SCHWALBE G-ONE ALLRND 700 x 38C

COMPONENTS

HANDLEBAR	ALUMINIUM 420 mm 31.8
HANDLEBAR STEM	ALUMINIUM 80 mm/31,87°
SEAT POST	ALUMINIUM 27,2 x 350 mm
HEADSET	FSA NO.42/ACB;1-1/8"-1,5"
SADDLE	FIZIK TERRA ARGO X5
GRIPS	FIZIK TERRA MICROTEx

GEOMETRY

SIZE	S	M	L	XL
FS - FRAME SIZE*	19	20	21	22
ST - SEAT TUBE LENGTH**	490	520	540	560
TT - TOP TUBE LENGTH**	520	535	550	565
HT - HEAD TUBE LENGTH**	120	140	150	170
SA - SEAT TUBE ANGLE***	74,5	74	73	73
HA - HEAD TUBE ANGLE***	70,5	71	71,5	72
CS - CHAINSTAY LENGTH**	435	435	435	435
WB - WHEELBASE**	1020	1027	1027	1037
REACH**	371	375	376	385
STACK**	537	557	568	590
BB DROP**	67	67	67	67

* dimension in inches, ** dimension in mm, *** dimension in degrees

ESKER 7.0



SKU	SIZE	COLOUR	FINISH
KREK7Z28X19M004984	S	purple	gloss
KREK7Z28X20M004985	M	purple	gloss
KREK7Z28X21M004986	L	purple	gloss
KREK7Z28X22M004987	XL	purple	gloss

GEAR RATIO 1 x 11
WHEEL DIAMETER 700C
COLOUR VARIANTS



FRAME

FRAME	CARBON T784
FORK	CARBON
SIZES	S(19"), M(20"), L(21"), XL(22")

DRIVETRAIN

REAR DERAILLEUR	SHIMANO GRX RX812
FRONT BRAKE	SHIMANO GRX RX400
REAR BRAKE	SHIMANO GRX RX400
BRAKE LEVERS	SHIMANO GRX RX600
BRAKE DISCS	SHIMANO RT30 (160 mm)
SHIFTERS	SHIMANO GRX RX600
CRANKSET	SHIMANO GRX RX600
SPROCKETS	40T/170 mm
BOTTOM BRACKET	SHIMANO BSA BB-RS500
CHAIN	SHIMANO HG601
CASSETTE/FREEWHEEL	SHIMANO SLX M7000
CASSETTE/FREEWHEEL RANGE	11-42T

WHEELS

FRONT HUB	SHIMANO RS470 12 x 100
REAR HUB	SHIMANO RS470 12 x 142
RIMS	DT SWISS G 540 622 x 24
TIRES	SCHWALBE G-ONE ALLRND 700 x 38C

COMPONENTS

HANDLEBAR	ALUMINIUM 420 mm 31.8
HANDLEBAR STEM	ALUMINIUM 80 mm/31,87°
SEAT POST	ALUMINIUM 27,2 x 350 mm
HEADSET	FSA NO.42/ACB:1-1/8"-1,5"
SADDLE	FIZIK TERRA ARGO X5
GRIPS	FIZIK TERRA MICROTEx

GEOMETRY

SIZE	S	M	L	XL
FS - FRAME SIZE*	19	20	21	22
ST - SEAT TUBE LENGTH**	490	520	540	560
TT - TOP TUBE LENGTH**	520	535	550	565
HT - HEAD TUBE LENGTH**	120	140	150	170
SA - SEAT TUBE ANGLE***	74,5	74	73	73
HA - HEAD TUBE ANGLE***	70,5	71	71,5	72
CS - CHAINSTAY LENGTH**	435	435	435	435
WB - WHEELBASE**	1020	1027	1027	1037
REACH**	371	375	376	385
STACK**	537	557	568	590
BB DROP**	67	67	67	67

* dimension in inches, ** dimension in mm, *** dimension in degrees

ESKER 7.0



SKU	SIZE	COLOUR	FINISH
KREK7Z28X19M006570	S	purple	gloss
KREK7Z28X20M006571	M	purple	gloss
KREK7Z28X21M006572	L	purple	gloss
KREK7Z28X22M006573	XL	purple	gloss

GEAR RATIO 1 x 11
WHEEL DIAMETER 700C
COLOUR VARIANTS



FRAME

FRAME	CARBON T784
FORK	CARBON
SIZES	S(19"), M(20"), L(21"), XL(22")

DRIVETRAIN

REAR DERAILLEUR	SRAM RIVAL
FRONT BRAKE	SRAM RIVAL
REAR BRAKE	SRAM RIVAL
BRAKE LEVERS	SRAM RIVAL
BRAKE DISCS	SHIMANO RT10 160 mm CL
SHIFTERS	SRAM RIVAL
CRANKSET	SRAM RIVAL 1 XSYNC
SPROCKETS	40T/170 mm
BOTTOM BRACKET	SRAM GXP
CHAIN	SRAM PC1110
CASSETTE/FREEWHEEL	SRAM 1130
CASSETTE/FREEWHEEL RANGE	11-42T

WHEELS

FRONT HUB	SHIMANO RS470 12 x 100
REAR HUB	SHIMANO RS470 12 x 142
RIMS	DT SWISS G540 24 mm 28H
TIRES	SCHWALBE G-ONE ALLRND 700 x 38C

COMPONENTS

HANDLEBAR	ALUMINIUM
HANDLEBAR STEM	ALUMINIUM 80 mm/31,87°
SEAT POST	ALUMINIUM 27,2 x 350 mm
HEADSET	FSA NO.42/ACB:1-1/8"-1,5"
SADDLE	FIZIK TERRA ARGO X5
GRIPS	FIZIK TERRA MICROTEx

GEOMETRY

SIZE	S	M	L	XL
FS - FRAME SIZE*	19	20	21	22
ST - SEAT TUBE LENGTH**	490	520	540	560
TT - TOP TUBE LENGTH**	520	535	550	565
HT - HEAD TUBE LENGTH**	120	140	150	170
SA - SEAT TUBE ANGLE***	74,5	74	73	73
HA - HEAD TUBE ANGLE***	70,5	71	71,5	72
CS - CHAINSTAY LENGTH**	435	435	435	435
WB - WHEELBASE**	1020	1027	1027	1037
REACH**	371	375	376	385
STACK**	537	557	568	590
BB DROP**	67	67	67	67

* dimension in inches, ** dimension in mm, *** dimension in degrees

ESKER 6.0, ESKER 5.0, ESKER 2.0

GENERATION 2

The first-generation Esker gained recognition among experienced gravel riders as well as novice cyclists who are seeking a versatile and reliable companion for exploring new routes and experiencing adventures. The bar was set high.

The new Esker of the second-generation is an exceptional choice for all those who want to unleash the full potential of gravel bikes and experience true joy in riding across diverse terrain, even the most challenging.

Comfortable and versatile: ready for every adventure - 're-designed' fulfils the dream of unlimited two-wheel riding possibilities.

Available to everyone - the new frame is available starting from the 2.0 Gen 2 model.





ESKER 6.0

NEW



SKU	SIZE	COLOUR	FINISH
KREK6Z28X18M006666	S	khaki	gloss
KREK6Z28X19M006667	M	khaki	gloss
KREK6Z28X20M006668	L	khaki	gloss
KREK6Z28X21M006669	XL	khaki	gloss
KREK6Z28X18M006670	S	black	gloss
KREK6Z28X19M006671	M	black	gloss
KREK6Z28X20M006672	L	black	gloss
KREK6Z28X21M006673	XL	black	gloss

GEAR RATIO 2 x 11
WHEEL DIAMETER 700C
COLOUR VARIANTS



FRAME

FRAME	ALUMINIUM
FORK	CARBON
SIZES	S(18"), M(19"), L(20"), XL(21")

DRIVETRAIN

FRONT DERAILLEUR	SHIMANO GRX RX810
REAR DERAILLEUR	SHIMANO GRX RX810
FRONT BRAKE	SHIMANO GRX RX400
REAR BRAKE	SHIMANO GRX RX400
BRAKE LEVERS	SHIMANO GRX RX600
BRAKE DISCS	SHIMANO RT30 160 mm CL
SHIFTERS	SHIMANO GRX RX600
CRANKSET	SHIMANO FC-RX600 GRX
SPROCKETS	46T-30T/170 mm
BOTTOM BRACKET	SHIMANO BSA BB-RS501
CHAIN	SHIMANO HG601
CASSETTE/FREEWHEEL	SHIMANO GRX RX600 HG700
CASSETTE/FREEWHEEL RANGE	11-34T

WHEELS

FRONT HUB	SHIMANO RS470 12 x 100
REAR HUB	SHIMANO RS470 12 x 142
RIMS	DT SWISS G 540 622 x 24
TIRES	WTB RIDDLER COMP 700 x 45C

COMPONENTS

HANDLEBAR	ALUMINIUM 420 mm 31.8
HANDLEBAR STEM	ALUMINIUM 60 mm/31,8/12°
SEAT POST	ALUMINIUM 27,2 x 350 mm
HEADSET	FSA 1-1/8"/1.5"
SADDLE	SELLE ROYAL RUN COMFORT GROOVE
GRIPS	FIZIK TERRA MICROTEx

GEOMETRY

SIZE	S	M	L	XL
FS - FRAME SIZE*	18	19	20	21
ST - SEAT TUBE LENGTH**	460	485	510	535
TT - TOP TUBE LENGTH**	545	561	577	591
HT - HEAD TUBE LENGTH**	120	135	155	175
SA - SEAT TUBE ANGLE***	74	74	74	74
HA - HEAD TUBE ANGLE***	71	71	71	71
CS - CHAINSTAY LENGTH**	430	430	430	430
WB - WHEELBASE**	376	387	398	406
REACH**	572	586	605	624
STACK**	1028	1045	1062	1077
BB DROP**	75	75	75	75

* dimension in inches, ** dimension in mm, *** dimension in degrees

ESKER 6.0



SKU	SIZE	COLOUR	FINISH
KREK6Z28X19M004360	S	black	gloss
KREK6Z28X20M004361	M	black	gloss
KREK6Z28X21M004362	L	black	gloss
KREK6Z28X22M004363	XL	black	gloss

GEAR RATIO 2 x 11

WHEEL DIAMETER 700C

COLOUR VARIANTS



FRAME

FRAME	ALUMINIUM SUPERLITE
FORK	CARBON
SIZES	S(19"), M(20"), L(21"), XL(22")

DRIVETRAIN

FRONT DERAILLEUR	SHIMANO GRX RX810
REAR DERAILLEUR	SHIMANO GRX RX810
FRONT BRAKE	SHIMANO GRX RX400
REAR BRAKE	SHIMANO GRX RX400
BRAKE LEVERS	SHIMANO GRX RX600
BRAKE DISCS	SHIMANO RT30 (160 mm)
SHIFTERS	SHIMANO GRX RX600
CRANKSET	SHIMANO GRX RX600
SPROCKETS	46T-30T/170 mm
BOTTOM BRACKET	SHIMANO BSA BB-RS500
CHAIN	SHIMANO HG601
CASSETTE/FREEWHEEL	SHIMANO GRX RX600 HG700
CASSETTE/FREEWHEEL RANGE	11-34T

WHEELS

FRONT HUB	SHIMANO RS470 12 x 100
REAR HUB	SHIMANO RS470 12 x 142
RIMS	DT SWISS R 500 622 x 22
TIRES	WTB RIDDLER COMP 700 x 37C

COMPONENTS

HANDLEBAR	ALUMINIUM 420 mm 31.8
HANDLEBAR STEM	ALUMINIUM 80 mm/31,8/7°
SEAT POST	ALUMINIUM 27,2 x 350 mm
HEADSET	FSA NO.42/ACB;1-1/8"-1,5"
SADDLE	WTB VOLT SPORT
GRIPS	FIZIK TERRA MICROTEX

GEOMETRY

SIZE	S	M	L	XL
FS - FRAME SIZE*	19	20	21	22
ST - SEAT TUBE LENGTH**	470	510	530	560
TT - TOP TUBE LENGTH**	510	530	550	570
HT - HEAD TUBE LENGTH**	130	145	160	180
SA - SEAT TUBE ANGLE***	75	74	73,5	73
HA - HEAD TUBE ANGLE***	69	71	71,5	72
CS - CHAINSTAY LENGTH**	436	436	436	436
WB - WHEELBASE**	1028	1019	1030	1039
REACH**	364	367	377	385
STACK**	546	568	584	605
BB DROP**	70	70	70	70

* dimension in inches, ** dimension in mm, *** dimension in degrees

ESKER 5.0

NEW



SKU	SIZE	COLOUR	FINISH
KREK5Z28X18M006658	S	orange	gloss
KREK5Z28X19M006659	M	orange	gloss
KREK5Z28X20M006660	L	orange	gloss
KREK5Z28X21M006661	XL	orange	gloss
KREK5Z28X18M006662	S	gray	gloss
KREK5Z28X19M006663	M	gray	gloss
KREK5Z28X20M006664	L	gray	gloss
KREK5Z28X21M006665	XL	gray	gloss

GEAR RATIO 2 x 10

WHEEL DIAMETER 700C

COLOUR VARIANTS



FRAME

FRAME	ALUMINIUM
FORK	CARBON
SIZES	S(18"), M(19"), L(20"), XL(21")

DRIVETRAIN

FRONT DERAILLEUR	SHIMANO GRX RX400
REAR DERAILLEUR	SHIMANO GRX RX400
FRONT BRAKE	SHIMANO GRX RX400
REAR BRAKE	SHIMANO GRX RX400
BRAKE LEVERS	SHIMANO GRX RX400
BRAKE DISCS	SHIMANO RT30 160 mm CL
SHIFTERS	SHIMANO GRX RX400
CRANKSET	FSA OMEGA MODULAR
SPROCKETS	46T-30T/172,5 mm
BOTTOM BRACKET	FSA MEGAEXO
CHAIN	SHIMANO HG54
CASSETTE/FREEWHEEL	SHIMANO CS-HG500-10
CASSETTE/FREEWHEEL RANGE	11-34T

WHEELS

FRONT HUB	SHIMANO RS470 12 x 100
REAR HUB	SHIMANO RS470 12 x 142
RIMS	DT SWISS R500 622 x 22
TIRES	WTB RIDDLER COMP 700 x 45C

COMPONENTS

HANDLEBAR	ALUMINIUM 420 mm 31.8
HANDLEBAR STEM	ALUMINIUM 60 mm/31,8/12°
SEAT POST	ALUMINIUM 27,2 x 350 mm
HEADSET	FSA 1-1/8"/1.5"
SADDLE	SELLE ROYAL RUN COMFORT GROOVE
GRIPS	FIZIK TERRA MICROTEx

GEOMETRY

SIZE	S	M	L	XL
FS - FRAME SIZE*	18	19	20	21
ST - SEAT TUBE LENGTH**	460	485	510	535
TT - TOP TUBE LENGTH**	545	561	577	591
HT - HEAD TUBE LENGTH**	120	135	155	175
SA - SEAT TUBE ANGLE***	74	74	74	74
HA - HEAD TUBE ANGLE***	71	71	71	71
CS - CHAINSTAY LENGTH**	430	430	430	430
WB - WHEELBASE**	376	387	398	406
REACH**	572	586	605	624
STACK**	1028	1045	1062	1077
BB DROP**	75	75	75	75

* dimension in inches, ** dimension in mm, *** dimension in degrees

ESKER

ALUMINIUM GEN 2 - DETAILS



ESKER 5.0



SKU	SIZE	COLOUR	FINISH
KREK5Z28X19M006986	S	turquoise	gloss
KREK5Z28X20M006567	M	turquoise	gloss
KREK5Z28X21M006568	L	turquoise	gloss

GEAR RATIO 1 x 11
WHEEL DIAMETER 700C
COLOUR VARIANTS



FRAME

FRAME	ALUMINIUM SUPERLITE
FORK	CARBON
SIZES	S(19"), M(20"), L(21")

DRIVETRAIN

REAR DERAILLEUR	SRAM APEX
FRONT BRAKE	SRAM APEX
REAR BRAKE	SRAM APEX
BRAKE LEVERS	SRAM APEX
BRAKE DISCS	SHIMANO RT10 160 mm CL
SHIFTERS	SRAM APEX
CRANKSET	SRAM APEX 1 XSYNC
SPROCKETS	40T/170 mm
BOTTOM BRACKET	SRAM BSA GXP
CHAIN	SRAM PC1110
CASSETTE/FREEWHEEL	SRAM PG1130 EAGLE
CASSETTE/FREEWHEEL RANGE	11-42T

WHEELS

FRONT HUB	GL-B63F-SB/CL
REAR HUB	GL-B63R-SB/CL
RIMS	KROSS ALUMINIUM 622 x 19
TIRES	WTB RIDDLER COMP 700 x 37C

COMPONENTS

HANDLEBAR	ALUMINIUM 420 mm 31.8
HANDLEBAR STEM	ALUMINIUM 80 mm/31.8/7°
SEAT POST	ALUMINIUM 27.2 x 350 mm
HEADSET	FSA NO.42/ACB:1-1/8"-1,5"
SADDLE	WTB VOLT SPORT
GRIPS	FIZIK TERRA MICROTEx

GEOMETRY

SIZE	S	M	L
FS - FRAME SIZE*	19	20	21
ST - SEAT TUBE LENGTH**	470	510	530
TT - TOP TUBE LENGTH**	510	530	550
HT - HEAD TUBE LENGTH**	130	145	160
SA - SEAT TUBE ANGLE***	75	74	73,5
HA - HEAD TUBE ANGLE***	69	71	71,5
CS - CHAINSTAY LENGTH**	436	436	436
WB - WHEELBASE**	1028	1019	1030
REACH**	364	367	377
STACK**	546	568	584
BB DROP**	70	70	70

* dimension in inches, ** dimension in mm, *** dimension in degrees

ESKER 5.0



SKU	SIZE	COLOUR	FINISH
KREK5Z28X19M004540	S	turquoise	gloss
KREK5Z28X20M004541	M	turquoise	gloss
KREK5Z28X21M004542	L	turquoise	gloss
KREK5Z28X22M004543	XL	turquoise	gloss

GEAR RATIO 2 x 10

WHEEL DIAMETER 700C

COLOUR VARIANTS



FRAME

FRAME	ALUMINIUM SUPERLITE
FORK	CARBON
SIZES	S(19"), M(20"), L(21"), XL(22")

DRIVETRAIN

FRONT DERAILLEUR	SHIMANO GRX RX400
REAR DERAILLEUR	SHIMANO GRX RX400
FRONT BRAKE	SHIMANO GRX RX400
REAR BRAKE	SHIMANO GRX RX400
BRAKE LEVERS	SHIMANO GRX RX400
BRAKE DISCS	SHIMANO RT30 (160 mm)
SHIFTERS	SHIMANO GRX RX400
CRANKSET	FSA OMEGA
SPROCKETS	46T-30T/170 mm
BOTTOM BRACKET	FSA MEGAE XO
CHAIN	SHIMANO HG54
CASSETTE/FREEWHEEL	SHIMANO CS-HG500-10
CASSETTE/FREEWHEEL RANGE	11-34T

WHEELS

FRONT HUB	SHIMANO RS470 12 x 100
REAR HUB	SHIMANO RS470 12 x 142
RIMS	KROSS ALUMINIUM 622 x 19
TIRES	WTB RIDDLER COMP 700 x 37C

COMPONENTS

HANDLEBAR	ALUMINIUM 420 mm 31.8
HANDLEBAR STEM	ALUMINIUM 80 mm/31,8/7°
SEAT POST	ALUMINIUM 27,2 x 350 mm
HEADSET	FSA NO.42/ACB;1-1/8"-1,5"
SADDLE	WTB VOLT SPORT
GRIPS	FIZIK TERRA MICROTEx

GEOMETRY

SIZE	S	M	L	XL
FS - FRAME SIZE*	19	20	21	22
ST - SEAT TUBE LENGTH**	470	510	530	560
TT - TOP TUBE LENGTH**	510	530	550	570
HT - HEAD TUBE LENGTH**	130	145	160	180
SA - SEAT TUBE ANGLE***	75	74	73,5	73
HA - HEAD TUBE ANGLE***	69	71	71,5	72
CS - CHAINSTAY LENGTH**	436	436	436	436
WB - WHEELBASE**	1028	1019	1030	1039
REACH**	364	367	377	385
STACK**	546	568	584	605
BB DROP**	70	70	70	70

* dimension in inches, ** dimension in mm, *** dimension in degrees

GRAVEL BIKEPACKING

- THE NEW STEEL ESKER

The steel Esker was designed for adventurous riding on various terrains. It is a travel-inspired bike that allows you to explore new routes, whether they are gravel roads or rugged trails. It perfectly combines performance, comfort and versatility. It is the perfect companion for both long rides and everyday off-road adventures.

Durable and comfortable frame: the steel Esker is made from Cr-Mo meld, providing a balance between comfort and durability.

Comfort and stability: the geometry of steel Esker is designed to provide stable handling and a comfortable position for ultra racing. Additionally, the carbon fork dampens vibrations, adding comfort during the ride.

Practicality and versatility: the new steel Esker is equipped with mounting points for carriers and mudguards, allowing for luggage transportation and bike customisation based on individual needs.

Aesthetics and details: in the new model, we've taken care of aesthetics and details, making it not only an efficient tool but also a beautiful and distinctive bike.





ESKER 4.0

NEW



SKU	SIZE	COLOUR	FINISH
KREK4Z28X19M006654	S	yellow	gloss
KREK4Z28X20M006655	M	yellow	gloss
KREK4Z28X21M006656	L	yellow	gloss
KREK4Z28X22M006657	XL	yellow	gloss
KREK4Z28X19M007418	S	green	gloss
KREK4Z28X20M007419	M	green	gloss
KREK4Z28X21M007420	L	green	gloss
KREK4Z28X22M007421	XL	green	gloss

GEAR RATIO 2 x 10

WHEEL DIAMETER 700C

COLOUR VARIANTS



FRAME

FRAME	CROMO STEEL
FORK	CARBON
SIZES	S(19"), M(20"), L(21"), XL(22")

DRIVETRAIN

FRONT DERAILLEUR	SHIMANO GRX RX400
REAR DERAILLEUR	SHIMANO GRX RX400
FRONT BRAKE	TEKTRO MD C550
REAR BRAKE	TEKTRO MD C550
BRAKE LEVERS	SHIMANO TIAGRA ST-4700
BRAKE DISCS	SHIMANO RT30 160 mm CL
SHIFTERS	SHIMANO TIAGRA ST-4700
CRANKSET	FSA OMEGA
SPROCKETS	46T-30T/172,5 mm
BOTTOM BRACKET	FSA MEGAEXO
CHAIN	SHIMANO HG54
CASSETTE/FREEWHEEL	SHIMANO GRX RX400 HG500
CASSETTE/FREEWHEEL RANGE	11-34T

WHEELS

FRONT HUB	SHIMANO RS470 12 x 100
REAR HUB	SHIMANO RS470 12 x 142
RIMS	KROSS ALUMINIUM 622 x 25
TIRES	WTB RESOLUTE COMP 700 x 42 C

COMPONENTS

HANDLEBAR	ALUMINIUM 420 mm 31.8
HANDLEBAR STEM	ALUMINIUM 80 mm/31,8/7°
SEAT POST	ALUMINIUM 27,2 x 350 mm
HEADSET	FSA OrbitITA NO.9M
SADDLE	SELLE ROYAL RUN COMFORT GROOVE
GRIPS	FIZIK TERRA MICROTEx

GEOMETRY

SIZE	S	M	L	XL
FS - FRAME SIZE*	19	20	21	22
ST - SEAT TUBE LENGTH**	470	510	530	560
TT - TOP TUBE LENGTH**	510	530	550	570
HT - HEAD TUBE LENGTH**	105	120	135	155
SA - SEAT TUBE ANGLE***	75	74	73,5	73
HA - HEAD TUBE ANGLE***	69	71	71,5	71
CS - CHAINSTAY LENGTH**	435	435	435	435
WB - WHEELBASE**	1025	1018	1028	1049
REACH**	367	371	381	391
STACK**	532	554	570	587
BB DROP**	70	70	70	70

* dimension in inches, ** dimension in mm, *** dimension in degrees

ESKER 4.0



SKU	SIZE	COLOUR	FINISH
KREK4Z28X19M005314	S	creamy	gloss
KREK4Z28X20M005315	M	creamy	gloss
KREK4Z28X21M005316	L	creamy	gloss
KREK4Z28X22M005317	XL	creamy	gloss

GEAR RATIO 1 x 10

WHEEL DIAMETER 700C

COLOUR VARIANTS



FRAME

FRAME	CROMO STEEL
FORK	CARBON
SIZES	S(19"), M(20"), L(21"), XL(22")

DRIVETRAIN

REAR DERAILLEUR	MICROSHIFT ADVENT M6205
FRONT BRAKE	TEKTRO MD C550
REAR BRAKE	TEKTRO MD C550
BRAKE LEVERS	MICROSHIFT ADVENT X
BRAKE DISCS	SHIMANO RT10 160 mm CL
SHIFTERS	SB-M100A
CRANKSET	PROWHEEL RPL-FD16S-F-TT
SPROCKETS	40T/170 mm
BOTTOM BRACKET	PROWHEEL BB68+
CHAIN	YBN SH10
CASSETTE/FREEWHEEL	MICROSHIFT CS-H103
CASSETTE/FREEWHEEL RANGE	11-42T

WHEELS

FRONT HUB	GL-B63-F/CL
REAR HUB	GL-B63R-SB/CL-X12
RIMS	KROSS ALUMINIUM 622 x 19
TIRES	WANDA W3113 700 x 38C

COMPONENTS

HANDLEBAR	ALUMINIUM 420 mm 31.8
HANDLEBAR STEM	ALUMINIUM 80 mm/31.8/7°
SEAT POST	ALUMINIUM 27,2 x 350 mm
HEADSET	FSA OrbitITA NO.9M
SADDLE	WTB VOLT SPORT
GRIPS	FIZIK TERRA MICROTEx

GEOMETRY

SIZE	S	M	L	XL
FS - FRAME SIZE*	19	20	21	22
ST - SEAT TUBE LENGTH**	470	510	530	560
TT - TOP TUBE LENGTH**	510	530	550	570
HT - HEAD TUBE LENGTH**	105	120	135	155
SA - SEAT TUBE ANGLE***	75	74	73,5	73
HA - HEAD TUBE ANGLE***	69	71	71,5	71
CS - CHAINSTAY LENGTH**	435	435	435	435
WB - WHEELBASE**	1025	1018	1028	1049
REACH**	367	371	381	391
STACK**	532	554	570	587
BB DROP**	70	70	70	70

* dimension in inches, ** dimension in mm, *** dimension in degrees

ESKER 2.0

NEW



SKU	SIZE	COLOUR	FINISH
KREK2Z28X18M006646	S	brown	gloss
KREK2Z28X19M006647	M	brown	gloss
KREK2Z28X20M006648	L	brown	gloss
KREK2Z28X21M006649	XL	brown	gloss
KREK2Z28X19M006650	S	navy	gloss
KREK2Z28X20M006651	M	navy	gloss
KREK2Z28X21M006652	L	navy	gloss
KREK2Z28X21M006653	XL	navy	gloss

GEAR RATIO 1 x 10

WHEEL DIAMETER 700C

COLOUR VARIANTS



FRAME

FRAME	ALUMINIUM
FORK	CARBON
SIZES	S(18"), M(19"), L(20"), XL(21")

DRIVETRAIN

REAR DERAILLEUR	MICROSHIFT SWORD RD-G7005M
FRONT BRAKE	TEKTRO MD C550
REAR BRAKE	TEKTRO MD C550
BRAKE LEVERS	MICROSHIFT SWORD SB-G7000
BRAKE DISCS	TEKTRO TR160 mm 160 mm CL
SHIFTERS	MICROSHIFT SWORD SB-G7000
CRANKSET	PROWHEEL RPL-FD16S-F-TT
SPROCKETS	40T
BOTTOM BRACKET	PROWHEEL BB68+
CHAIN	SHIMANO HG54
CASSETTE/FREEWHEEL	MICROSHIFT CS-H104
CASSETTE/FREEWHEEL RANGE	11-48T

WHEELS

FRONT HUB	SHIMANO RS470 12 x 100
REAR HUB	SHIMANO RS470 12 x 142
RIMS	KROSS ALUMINIUM 622 x 25
TIRES	WTB RIDDLER COMP 700 x 45C

COMPONENTS

HANDLEBAR	ALUMINIUM 420 mm 31.8
HANDLEBAR STEM	ALUMINIUM 80 mm/31.8/7°
SEAT POST	ALUMINIUM 27,2 x 350 mm
HEADSET	FSA 1-1/8"/1.5"
SADDLE	WTB VOLT SPORT
GRIPS	SELLE ROYAL RUN COMFORT GROOVE

GEOMETRY

SIZE	S	M	L	XL
FS - FRAME SIZE*	18	19	20	21
ST - SEAT TUBE LENGTH**	460	485	510	535
TT - TOP TUBE LENGTH**	545	561	577	591
HT - HEAD TUBE LENGTH**	120	135	155	175
SA - SEAT TUBE ANGLE***	74	74	74	74
HA - HEAD TUBE ANGLE***	71	71	71	71
CS - CHAINSTAY LENGTH**	430	430	430	430
WB - WHEELBASE**	376	387	398	406
REACH**	572	586	605	624
STACK**	1028	1045	1062	1077
BB DROP**	75	75	75	75

* dimension in inches, ** dimension in mm, *** dimension in degrees



ESKER 2.0



SKU	SIZE	COLOUR	FINISH
KREK2Z28X19M003094	S	ruby	gloss
KREK2Z28X20M003095	M	ruby	gloss
KREK2Z28X21M003096	L	ruby	gloss
KREK2Z28X22M003097	XL	ruby	gloss

GEAR RATIO 2 x 9
WHEEL DIAMETER 700C
COLOUR VARIANTS



FRAME

FRAME	ALUMINIUM LITE
FORK	ALUMINIUM
SIZES	S(19"), M(20"), L(21"), XL(22")

DRIVETRAIN

FRONT DERAILLEUR	SHIMANO SORA R3000
REAR DERAILLEUR	SHIMANO SORA R3000
FRONT BRAKE	TEKTRO MD C550
REAR BRAKE	TEKTRO MD C550
BRAKE LEVERS	SHIMANO SORA R3000
BRAKE DISCS	TEKTRO (160 mm)
SHIFTERS	SHIMANO SORA R3000
CRANKSET	SHIMANO SORA R3000
SPROCKETS	50T-34T/170 mm
BOTTOM BRACKET	SHIMANO BSA BB-RS500
CHAIN	SHIMANO HG53
CASSETTE/FREEWHEEL	SHIMANO ALTUS HG201
CASSETTE/FREEWHEEL RANGE	11-34T

WHEELS

FRONT HUB	SHIMANO ACERA M3050
REAR HUB	SHIMANO ACERA M3050
RIMS	KROSS ALUMINIUM 622 x 19
TIRES	WTB RIDDLER COMP 700 x 37C

COMPONENTS

HANDLEBAR	ALUMINIUM 420 mm 31.8
HANDLEBAR STEM	ALUMINIUM 80 mm/31,8/7°
SEAT POST	ALUMINIUM 27,2 x 350 mm
HEADSET	FSA NO.42/ACB;1-1/8"-1,5"
SADDLE	WTB VOLT SPORT
GRIPS	FIZIK TERRA MICROTEX

GEOMETRY

SIZE	S	M	L	XL
FS - FRAME SIZE*	19	20	21	22
ST - SEAT TUBE LENGTH**	470	510	530	560
TT - TOP TUBE LENGTH**	510	530	550	570
HT - HEAD TUBE LENGTH**	130	145	160	180
SA - SEAT TUBE ANGLE***	75	74	73,5	73
HA - HEAD TUBE ANGLE***	69	71	71,5	72
CS - CHAINSTAY LENGTH**	436	436	436	436
WB - WHEELBASE**	1028	1019	1030	1039
REACH**	364	367	377	385
STACK**	546	568	584	605
BB DROP**	70	70	70	70

* dimension in inches, ** dimension in mm, *** dimension in degrees

ESKER 2.0



SKU	SIZE	COLOUR	FINISH
KREK2Z28X19M004980	S	ruby	gloss
KREK2Z28X20M004981	M	ruby	gloss
KREK2Z28X21M004982	L	ruby	gloss
KREK2Z28X22M004983	XL	ruby	gloss

GEAR RATIO 1 x 10

WHEEL DIAMETER 700C

COLOUR VARIANTS



FRAME

FRAME	ALUMINIUM LITE
FORK	CARBON
SIZES	S(19"), M(20"), L(21"), XL(22")

DRIVETRAIN

REAR DERAILLEUR	MICROSHIFT ADVENT M6205
FRONT BRAKE	TEKTRO MD C550
REAR BRAKE	TEKTRO MD C550
BRAKE LEVERS	MICROSHIFT ADVENT X
BRAKE DISCS	TEKTRO (160 mm)
SHIFTERS	SB-M100A
CRANKSET	PROWHEEL RPL-FD16S-F-TT
SPROCKETS	40T/170 mm
BOTTOM BRACKET	PROWHEEL BB68+
CHAIN	SHIMANO HG54
CASSETTE/FREEWHEEL	MICROSHIFT CS-H103
CASSETTE/FREEWHEEL RANGE	11-42T

WHEELS

FRONT HUB	GL-B63-F/CL
REAR HUB	GL-B63R-SB/CL-X12
RIMS	KROSS ALUMINIUM 622 x 19
TIRES	WANDA W3113 700 x 38C

COMPONENTS

HANDLEBAR	ALUMINIUM 420 mm 31.8
HANDLEBAR STEM	ALUMINIUM 80 mm/31.8/7°
SEAT POST	ALUMINIUM 27.2 x 350 mm
HEADSET	FSA NO.42/ACB:1-1/8"-1,5"
SADDLE	WTB VOLT SPORT
GRIPS	FIZIK TERRA MICROTEx

GEOMETRY

SIZE	S	M	L	XL
FS - FRAME SIZE*	19	20	21	22
ST - SEAT TUBE LENGTH**	470	510	530	560
TT - TOP TUBE LENGTH**	510	530	550	570
HT - HEAD TUBE LENGTH**	130	145	160	180
SA - SEAT TUBE ANGLE***	75	74	73,5	73
HA - HEAD TUBE ANGLE***	69	71	71,5	72
CS - CHAINSTAY LENGTH**	436	436	436	436
WB - WHEELBASE**	1028	1019	1030	1039
REACH**	364	367	377	385
STACK**	546	568	584	605
BB DROP**	70	70	70	70

* dimension in inches, ** dimension in mm, *** dimension in degrees

ESKER 1.0

NEW



SKU	SIZE	COLOUR	FINISH
KREK1Z28X19M007446	S	beige	gloss
KREK1Z28X20M007447	M	beige	gloss
KREK1Z28X21M007448	L	beige	gloss
KREK1Z28X22M007449	XL	beige	gloss
KREK1Z28X19M007450	S	blue	gloss
KREK1Z28X20M007451	M	blue	gloss
KREK1Z28X21M007452	L	blue	gloss
KREK1Z28X22M007453	XL	blue	gloss

GEAR RATIO 2 x 8
WHEEL DIAMETER 700C
COLOUR VARIANTS



FRAME

FRAME	ALUMINIUM
FORK	ALUMINIUM
SIZES	S(19"), M(20"), L(21"), XL(22")

DRIVETRAIN

FRONT DERAILLEUR	SHIMANO CLARIS R2000
REAR DERAILLEUR	SHIMANO CLARIS R2000
FRONT BRAKE	TEKTRO MD C550
REAR BRAKE	TEKTRO MD C550
BRAKE LEVERS	SHIMANO CLARIS R2000
BRAKE DISCS	TEKTRO TR160 mm 160 mm CL
SHIFTERS	SHIMANO CLARIS R2000
CRANKSET	FSA TEMPO ADVENTURE
SPROCKETS	46T-30T/175 mm
BOTTOM BRACKET	FP-B902
CHAIN	SHIMANO HG40
CASSETTE/FREEWHEEL	SHIMANO ACERA HG41
CASSETTE/FREEWHEEL RANGE	11-32T

WHEELS

FRONT HUB	GULI GL-B57F
REAR HUB	GULI GL-B57R
RIMS	KROSS ALUMINIUM 622 x 19
TIRES	WTB RIDDLER COMP 700 x 37C

COMPONENTS

HANDLEBAR	ALUMINIUM 420 mm 31.8
HANDLEBAR STEM	ALUMINIUM 80 mm/31,8/7°
SEAT POST	ALUMINIUM 27,2 x 350 mm
HEADSET	FSA NO.42/ACB;1-1/8"-1,5"
SADDLE	SELLE ROYAL RUN COMFORT GROOVE
GRIPS	FIZIK TERRA MICROTEx

GEOMETRY

SIZE	S	M	L	XL
FS - FRAME SIZE*	19	20	21	22
ST - SEAT TUBE LENGTH**	470	510	530	560
TT - TOP TUBE LENGTH**	510	530	550	570
HT - HEAD TUBE LENGTH**	130	145	160	180
SA - SEAT TUBE ANGLE***	75	74	73,5	73
HA - HEAD TUBE ANGLE***	69	71	71,5	72
CS - CHAINSTAY LENGTH**	436	436	436	436
WB - WHEELBASE**	1028	1019	1030	1039
REACH**	364	367	377	385
STACK**	546	568	584	605
BB DROP**	70	70	70	70

* dimension in inches, ** dimension in mm, *** dimension in degrees

ESKER 1.0



SKU	SIZE	COLOUR	FINISH
KREK1Z28X19M002727	S	gray	gloss
KREK1Z28X20M002728	M	gray	gloss
KREK1Z28X21M002729	L	gray	gloss
KREK1Z28X22M002730	XL	gray	gloss

GEAR RATIO 2 x 8
WHEEL DIAMETER 700C
COLOUR VARIANTS



FRAME

FRAME	ALUMINIUM LITE
FORK	ALUMINIUM
SIZES	S(19"), M(20"), L(21"), XL(22")

DRIVETRAIN

FRONT DERAILLEUR	SHIMANO CLARIS R2000
REAR DERAILLEUR	SHIMANO CLARIS R2000
FRONT BRAKE	TEKTRO MD C550
REAR BRAKE	TEKTRO MD C550
BRAKE LEVERS	SHIMANO CLARIS R2000
BRAKE DISCS	TEKTRO (160 mm)
SHIFTERS	SHIMANO CLARIS R2000
CRANKSET	FSA TEMPO
SPROCKETS	46T-30T/175 mm
BOTTOM BRACKET	FP-B902
CHAIN	SHIMANO HG40
CASSETTE/FREEWHEEL	SHIMANO ACERA HG41
CASSETTE/FREEWHEEL RANGE	11-32T

WHEELS

FRONT HUB	GL-B57F-D
REAR HUB	GL-B57R-D
RIMS	KROSS ALUMINIUM 622 x 19
TIRES	WTB RIDDLER COMP 700 x 37C

COMPONENTS

HANDLEBAR	ALUMINIUM 420 mm 31.8
HANDLEBAR STEM	ALUMINIUM 80 mm/31,8/7°
SEAT POST	ALUMINIUM 27,2 x 350 mm
HEADSET	FSA NO.42/ACB;1-1/8"-1,5"
SADDLE	SELLE ROYAL 2043HRN
GRIPS	FIZIK TERRA MICROTEX

GEOMETRY

SIZE	S	M	L	XL
FS - FRAME SIZE*	19	20	21	22
ST - SEAT TUBE LENGTH**	470	510	530	560
TT - TOP TUBE LENGTH**	510	530	550	570
HT - HEAD TUBE LENGTH**	130	145	160	180
SA - SEAT TUBE ANGLE***	75	74	73,5	73
HA - HEAD TUBE ANGLE***	69	71	71,5	72
CS - CHAINSTAY LENGTH**	436	436	436	436
WB - WHEELBASE**	1028	1019	1030	1039
REACH**	364	367	377	385
STACK**	546	568	584	605
BB DROP**	70	70	70	70

* dimension in inches, ** dimension in mm, *** dimension in degrees

ESKER 1.0 MS



SKU	SIZE	COLOUR	FINISH
KREK1Z28X19M004344	S	gray	gloss
KREK1Z28X20M004345	M	gray	gloss
KREK1Z28X21M004346	L	gray	gloss
KREK1Z28X22M004347	XL	gray	gloss

GEAR RATIO 1 x 9
WHEEL DIAMETER 700C
COLOUR VARIANTS



FRAME

FRAME	ALUMINIUM LITE
FORK	ALUMINIUM
SIZES	S(19"), M(20"), L(21"), XL(22")

DRIVETRAIN

REAR DERAILLEUR	MICROSHIFT ADVENT M6195
FRONT BRAKE	RADIUS BH-RS910
REAR BRAKE	RADIUS BH-RS910
BRAKE LEVERS	MICROSHIFT ADVENT X
BRAKE DISCS	RADIUS RT900 (160 mm)
SHIFTERS	MICROSHIFT ADVENT SB-M090
CRANKSET	PROWHEEL RPP FD16S-TT
SPROCKETS	40T/175 mm
BOTTOM BRACKET	PROWHEEL BB68+
CHAIN	SHIMANO HG53
CASSETTE/FREEWHEEL	MICROSHIFT CS-H093
CASSETTE/FREEWHEEL RANGE	11-42T

WHEELS

FRONT HUB	GL-B57F-D
REAR HUB	GL-B57R-D
RIMS	KROSS ALUMINIUM 622 x 19
TIRES	WANDA W3113 700 x 38C

COMPONENTS

HANDLEBAR	ALUMINIUM 420 mm 31.8
HANDLEBAR STEM	ALUMINIUM 80 mm/31.8/7°
SEAT POST	ALUMINIUM 27.2 x 350 mm
HEADSET	FSA NO.42/ACB:1-1/8"-1,5"
SADDLE	SELLE ROYAL 2043HRN
GRIPS	FIZIK TERRA MICROTEx

GEOMETRY

SIZE	S	M	L	XL
FS - FRAME SIZE*	19	20	21	22
ST - SEAT TUBE LENGTH**	470	510	530	560
TT - TOP TUBE LENGTH**	510	530	550	570
HT - HEAD TUBE LENGTH**	130	145	160	180
SA - SEAT TUBE ANGLE***	75	74	73,5	73
HA - HEAD TUBE ANGLE***	69	71	71,5	72
CS - CHAINSTAY LENGTH**	436	436	436	436
WB - WHEELBASE**	1028	1019	1030	1039
REACH**	364	367	377	385
STACK**	546	568	584	605
BB DROP**	70	70	70	70

* dimension in inches, ** dimension in mm, *** dimension in degrees

ESKER HYBRID 2.0



SKU	SIZE	COLOUR	FINISH
KRKH2Z28X19M006472	M	khaki-black	gloss
KRKH2Z28X21M006473	L	khaki-black	gloss

GEAR RATIO 1 x 10

WHEEL DIAMETER 700C

COLOUR VARIANTS



FRAME

FRAME	ALUMINIUM PERFORMANCE
FORK	ALUMINIUM
SIZES	M(19"), L(21")

DRIVETRAIN

REAR DERAILLEUR	MICROSHIFT ADVENT M6205
FRONT BRAKE	TEKTRO TRP HDC711
REAR BRAKE	TEKTRO TRP HDC711
BRAKE LEVERS	MICROSHIFT ADVENT X
BRAKE DISCS	DISC (160 mm)
SHIFTERS	SB-M100A 1X10S ADVENT X
CRANKSET	PROWHEEL RPL-FD16S-F
SPROCKETS	40T
BOTTOM BRACKET	HYENA
CHAIN	YBN E-BIKE
CASSETTE/FREEWHEEL	MICROSHIFT CS-H103
CASSETTE/FREEWHEEL RANGE	11-42T

WHEELS

FRONT HUB	GL-B43F-DS
REAR HUB	HYENA
RIMS	KROSS ALUMINIUM 622 x 25
TIRES	WTB RESOLUTE 28 x 1,625

COMPONENTS

HANDLEBAR	ALUMINIUM 420 mm 31.8
HANDLEBAR STEM	ALUMINIUM 90 mm/31.8/7°
SEAT POST	ALUMINIUM 27,2 x 350 mm
HEADSET	ALUMINIUM
SADDLE	WTB VOLT SPORT
GRIPS	FIZIK TERRA MICROTEx
PEDALS	FP-210ZU
BATTERY	HYENA GIRAFFE
ENGINE	HYENA MRC-250
DISPLAY	HYENA LCD COMPACT EX

GEOMETRY

SIZE	M	L
FS - FRAME SIZE*	19	21
ST - SEAT TUBE LENGTH**	475	525
TT - TOP TUBE LENGTH**	580	605
HT - HEAD TUBE LENGTH**	160	190
SA - SEAT TUBE ANGLE***	73	73
HA - HEAD TUBE ANGLE***	70,5	70,5
CS - CHAINSTAY LENGTH**	445	445
WB - WHEELBASE**	1080	1107
REACH**	403	420
STACK**	578	606
BB DROP**	60	60

* dimension in inches, ** dimension in mm, *** dimension in degrees

ROAD BIKES

VENTO

KROSS Vento is a line of bikes specially designed for fast road riding. Vento will adapt to your needs - whether you are preparing for the season or competing.

It is the perfect companion for your first road adventures, as well as a tool for winning road races.

Top-tier components - such as electronic Shimano Di2 derailleurs on Vento 9.0

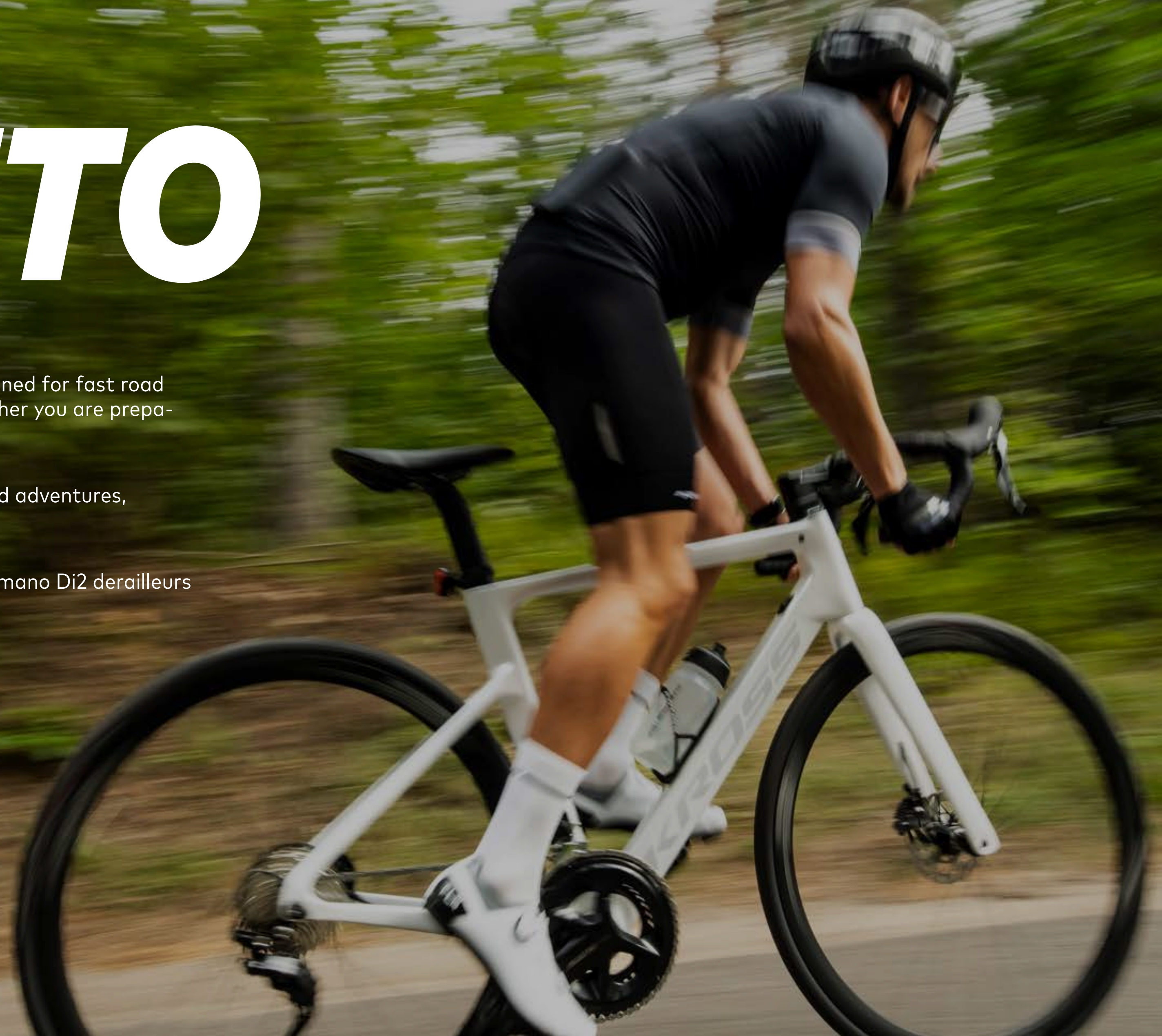



VENTO 9.0

NEW



SKU	SIZE	COLOUR	FINISH
KRVE9Z28X18M007382	S	green	gloss
KRVE9Z28X19M007383	M	green	gloss
KRVE9Z28X20M007384	L	green	gloss
KRVE9Z28X21M007385	XL	green	gloss

GEAR RATIO 2 x 12

WHEEL DIAMETER 700C

COLOUR VARIANTS



FRAME

FRAME	CARBON
FORK	CARBON
SIZES	S(18"), M(19"), L(20"), XL(21")

DRIVETRAIN

FRONT DERAILLEUR	SHIMANO 105 Di2
REAR DERAILLEUR	SHIMANO 105 Di2 R7150
FRONT BRAKE	SHIMANO 105 BR-R7170
REAR BRAKE	SHIMANO 105 BR-R7170
BRAKE LEVERS	SHIMANO 105 Di2 R7170
BRAKE DISCS	SHIMANO RT70 140 CL
SHIFTERS	SHIMANO 105 Di2 R7170
CRANKSET	SHIMANO FC-R7100
SPROCKETS	52T-36T/ 172,5 mm
BOTTOM BRACKET	SHIMANO BB72
CHAIN	SHIMANO M7100
CASSETTE/FREEWHEEL	SHIMANO 105 HG710
CASSETTE/FREEWHEEL RANGE	11-36T

WHEELS

FRONT HUB	VISION TRIMAX 12 x 100
REAR HUB	VISION TRIMAX 12 x 142
RIMS	FSA TRIMAX 35
TIRES	SCHWALBE PRO ONE EVO 700 x 28C

COMPONENTS

HANDLEBAR	FSA GOSSAMER COMP 400 mm
HANDLEBAR STEM	FSA NS ACR STEM 90 mm/31,8/-6°
SEAT POST	CARBON AERO SP-236
HEADSET	FSA ACR NO.55R 1.5"/ACR/STD
SADDLE	FIZIK ARGOVENTO R5
GRIPS	FIZIK TERRA MICROTEx

GEOMETRY

SIZE	S	M	L	XL
FS - FRAME SIZE*	18	19	20	21
ST - SEAT TUBE LENGTH**	464	492	512	534
TT - TOP TUBE LENGTH**	528	548	570	585
HT - HEAD TUBE LENGTH**	130	155	170	190
SA - SEAT TUBE ANGLE***	73,5	73,5	73,5	73,5
HA - HEAD TUBE ANGLE***	72	72	72	72
CS - CHAINSTAY LENGTH**	415	415	415	415
WB - WHEELBASE**	984	997	1019	1035
REACH**	369	381	397	408
STACK**	538	564	579	598
BB DROP**	72	72	72	72

* dimension in inches, ** dimension in mm, *** dimension in degrees

VENTO 8.0

NEW



SKU	SIZE	COLOUR	FINISH
KRVE8Z28X18M007378	S	pearl	gloss
KRVE8Z28X19M007379	M	pearl	gloss
KRVE8Z28X20M007380	L	pearl	gloss
KRVE8Z28X21M007381	XL	pearl	gloss

GEAR RATIO 2 x 12

WHEEL DIAMETER 700C

COLOUR VARIANTS

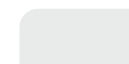

FRAME

FRAME	CARBON
FORK	CARBON
SIZES	S(18"), M(19"), L(20"), XL(21")

DRIVETRAIN

FRONT DERAILLEUR	SHIMANO 105 R7100
REAR DERAILLEUR	SHIMANO 105 R7100
FRONT BRAKE	SHIMANO 105 7170
REAR BRAKE	SHIMANO 105 7120
BRAKE LEVERS	SHIMANO 105 7120
BRAKE DISCS	SHIMANO RT70 140 CL
SHIFTERS	SHIMANO 105 R7120 12s
CRANKSET	SHIMANO 105 FC-R7100
SPROCKETS	52T-36T
BOTTOM BRACKET	SHIMANO SM-BB72-41B PF
CHAIN	SHIMANO CN-M7100-12
CASSETTE/FREEWHEEL	SHIMANO 105 CS-HG710-12
CASSETTE/FREEWHEEL RANGE	11-36T

WHEELS

FRONT HUB	VISION
REAR HUB	VISION
RIMS	VISION TEAM 35
TIRES	SCHWALBE PRO ONE EVO 700 x 28C

COMPONENTS

HANDLEBAR	TRIMAX AERO 420
HANDLEBAR STEM	FSA GOSSAMER 90 mm/31,8/6°
SEAT POST	CARBON AERO SP-236
HEADSET	FSA NO.55R
SADDLE	FIZIK ARGOVENTO R5
GRIPS	FIZIK TERRA MICROTEx

GEOMETRY

SIZE	S	M	L	XL
FS - FRAME SIZE*	18	19	20	21
ST - SEAT TUBE LENGTH**	464	492	512	534
TT - TOP TUBE LENGTH**	528	548	570	585
HT - HEAD TUBE LENGTH**	130	155	170	190
SA - SEAT TUBE ANGLE***	73,5	73,5	73,5	73,5
HA - HEAD TUBE ANGLE***	72	72	72	72
CS - CHAINSTAY LENGTH**	415	415	415	415
WB - WHEELBASE**	984	997	1019	1035
REACH**	369	381	397	408
STACK**	538	564	579	598
BB DROP**	72	72	72	72

* dimension in inches, ** dimension in mm, *** dimension in degrees

VENTO DSC 8.0



SKU	SIZE	COLOUR	FINISH
KRVD8Z28X18M002638	S	black-gray	gloss
KRVD8Z28X19M002639	M	black-gray	gloss
KRVD8Z28X20M002640	L	black-gray	gloss
KRVD8Z28X21M002641	XL	black-gray	gloss

GEAR RATIO 2 x 11
WHEEL DIAMETER 700C
COLOUR VARIANTS



FRAME

FRAME	CARBON
FORK	CARBON
SIZES	S(18"), M(19"), L(20"), XL(21")

DRIVETRAIN

FRONT DERAILLEUR	SHIMANO 105 R7000
REAR DERAILLEUR	SHIMANO 105 R7000
FRONT BRAKE	SHIMANO 105 R7070
REAR BRAKE	SHIMANO 105 7070
BRAKE LEVERS	SHIMANO 105 R7020
SHIFTERS	SHIMANO 105 R7000
CRANKSET	SHIMANO 105 R7000
SPROCKETS	52T-36T/170 mm
BOTTOM BRACKET	SHIMANO PRESS FIT BB72-41B
CHAIN	SHIMANO HG601
CASSETTE/FREEWHEEL	SHIMANO 105 R7000
CASSETTE/FREEWHEEL RANGE	11-28T

WHEELS

FRONT HUB	FSA TRIMAX
REAR HUB	FSA TRIMAX
RIMS	FSA TRIMAX 35
TIRES	SCHWALBE PRO ONE 700 x 28C

COMPONENTS

HANDLEBAR	FSA GOSSAMER COMP 400 mm
HANDLEBAR STEM	FSA NS ACR STEM 80 mm/31,8/-6°
SEAT POST	CARBON AERO SP-236
HEADSET	FSA ACR NO.55R 1.5"/ACR/STD
SADDLE	FIZIK ARGOVENTO R5
GRIPS	FIZIK TERRA MICROTEx

GEOMETRY

SIZE	S	M	L	XL
FS - FRAME SIZE*	18	19	20	21
ST - SEAT TUBE LENGTH**	464	492	512	534
TT - TOP TUBE LENGTH**	528	548	570	585
HT - HEAD TUBE LENGTH**	130	155	170	190
SA - SEAT TUBE ANGLE***	73,5	73,5	73,5	73,5
HA - HEAD TUBE ANGLE***	72	72	72	72
CS - CHAINSTAY LENGTH**	415	415	415	415
WB - WHEELBASE**	984	997	1019	1035
REACH**	369	381	397	408
STACK**	538	564	579	598
BB DROP**	72	72	72	72

* dimension in inches, ** dimension in mm, *** dimension in degrees

VENTO 7.0



SKU	SIZE	COLOUR	FINISH
KRVE7Z28X19M002634	S	blue	gloss
KRVE7Z28X20M002635	M	blue	gloss
KRVE7Z28X21M002636	L	blue	gloss
KRVE7Z28X22M002637	XL	blue	gloss

GEAR RATIO 2 x 11
WHEEL DIAMETER 700C
COLOUR VARIANTS



FRAME

FRAME	CARBON
FORK	CARBON
SIZES	S(19"), M(20"), L(21"), XL(22")

DRIVETRAIN

FRONT DERAILLEUR	SHIMANO 105 R7000
REAR DERAILLEUR	SHIMANO 105 R7000
FRONT BRAKE	SHIMANO 105 R7000
REAR BRAKE	SHIMANO 105 R7000
BRAKE LEVERS	SHIMANO 105 R7000
SHIFTERS	SHIMANO 105 R7000
CRANKSET	SHIMANO 105 R7000
SPROCKETS	52T-36T/170 mm
BOTTOM BRACKET	SHIMANO PRESS FIT BB72-41B
CHAIN	SHIMANO HG601
CASSETTE/FREEWHEEL	SHIMANO 105 R7000
CASSETTE/FREEWHEEL RANGE	11-30T

WHEELS

FRONT HUB	FSA VISION TEAM 35
REAR HUB	FSA VISION TEAM 35
RIMS	FSA VISION TEAM35 700C
TIRES	SCHWALBE LUGANO KGUARD 700 x 25C

COMPONENTS

HANDLEBAR	FSA GOSSAMER COMP 400 mm
HANDLEBAR STEM	FSA GOSSAMER 80 mm/31,8/6°
SEAT POST	CARBON AERO SP-236
HEADSET	FSA NO.42/ACB;1-1/8"-1,5"
SADDLE	FIZIK ANTARES R7
GRIPS	FIZIK TERRA MICROTEx

GEOMETRY

SIZE	S	M	L	XL
FS - FRAME SIZE*	19	20	21	22
ST - SEAT TUBE LENGTH**	480	510	540	570
TT - TOP TUBE LENGTH**	536	548	565	587
HT - HEAD TUBE LENGTH**	150	170	195	220
SA - SEAT TUBE ANGLE***	74	73,5	73,2	73
HA - HEAD TUBE ANGLE***	72,5	73	73,5	73,5
CS - CHAINSTAY LENGTH**	405	405	405	405
WB - WHEELBASE**	976	979	988	1007
REACH**	378	379	385	397
STACK**	550	571	597	621
BB DROP**	69	69	69	69

* dimension in inches, ** dimension in mm, *** dimension in degrees

VENTO 5.0

NEW



SKU	SIZE	COLOUR	FINISH
KRVE5Z28X20M007374	S	navy	gloss
KRVE5Z28X21M007375	M	navy	gloss
KRVE5Z28X22M007376	L	navy	gloss
KRVE5Z28X23M007377	XL	navy	gloss

GEAR RATIO 2 x 11
WHEEL DIAMETER 700C
COLOUR VARIANTS



FRAME

FRAME	ALUMINIUM
FORK	CARBON
SIZES	S(20"), M(21"), L(22"), XL(23")

DRIVETRAIN

FRONT DERAILLEUR	SHIMANO 105 R7000
REAR DERAILLEUR	SHIMANO 105 R7000
FRONT BRAKE	SHIMANO 105 R7000
REAR BRAKE	SHIMANO 105 R7000
BRAKE LEVERS	SHIMANO 105 R7000
SHIFTERS	SHIMANO 105 R7000
CRANKSET	SHIMANO FC-R7000 105
SPROCKETS	52T-36T/170 mm
BOTTOM BRACKET	SHIMANO BSA BB-RS501
CHAIN	SHIMANO HG601
CASSETTE/FREEWHEEL	SHIMANO 105 R7000
CASSETTE/FREEWHEEL RANGE	11-28T

WHEELS

FRONT HUB	VISION TEAM 12 x 100
REAR HUB	VISION TEAM 12 x 142
RIMS	FSA VISION TEAM30 700C
TIRES	SCHWALBE LUGANO KGUARD 700 x 28C

COMPONENTS

HANDLEBAR	ALUMINIUM 400 mm 31.8
HANDLEBAR STEM	ALUMINIUM 80 mm/31.8/7°
SEAT POST	ALUMINIUM 27.2 x 350 mm
HEADSET	FSA NO.42/ACB:1-1/8"-1.5"
SADDLE	SELLE ROYAL 2043HRN
GRIPS	KROSS EVA

GEOMETRY

SIZE	S	M	L	XL
FS - FRAME SIZE*	20	21	22	23
ST - SEAT TUBE LENGTH**	500	530	560	590
TT - TOP TUBE LENGTH**	543	554	573	585
HT - HEAD TUBE LENGTH**	160	175	195	205
SA - SEAT TUBE ANGLE***	73,5	73,5	73	73
HA - HEAD TUBE ANGLE***	72,5	72,5	73	73
CS - CHAINSTAY LENGTH**	421	421	421	421
WB - WHEELBASE**	992	1003	1012	1024
REACH**	377	384	391	400
STACK**	560	574	595	610
BB DROP**	70	70	70	70

* dimension in inches, ** dimension in mm, *** dimension in degrees

VENTO DSC 5.0



SKU	SIZE	COLOUR	FINISH
KRVD5Z28X20M004532	S	graphite-black	mat
KRVD5Z28X21M004533	M	graphite-black	mat
KRVD5Z28X22M004534	L	graphite-black	mat
KRVD5Z28X23M004535	XL	graphite-black	mat

GEAR RATIO 2 x 11

WHEEL DIAMETER 700C

COLOUR VARIANTS



FRAME

FRAME	ALUMINIUM LITE
FORK	CARBON
SIZES	S(20"), M(21"), L(22"), XL(23")

DRIVETRAIN

FRONT DERAILLEUR	SHIMANO 105 R7000
REAR DERAILLEUR	SHIMANO 105 R7000
FRONT BRAKE	SHIMANO 105 R7070
REAR BRAKE	SHIMANO 105 R7070
BRAKE LEVERS	SHIMANO 105 R7020
BRAKE DISCS	SHIMANO RT30 (160)
SHIFTERS	SHIMANO 105 R7020
CRANKSET	SHIMANO 105 R7000
SPROCKETS	52T-36T/170 mm
BOTTOM BRACKET	SHIMANO BSA BB-RS500
CHAIN	SHIMANO HG601
CASSETTE/FREEWHEEL	SHIMANO 105 R7000
CASSETTE/FREEWHEEL RANGE	11-28T

WHEELS

FRONT HUB	FSA TEAM 12 x 100
REAR HUB	FSA TEAM 12 x 142
RIMS	FSA VISION TEAM30 700C
TIRES	SCHWALBE LUGANO II 700 x 28C

COMPONENTS

HANDLEBAR	ALUMINIUM 400 mm 31.8
HANDLEBAR STEM	ALUMINIUM 80 mm/31,8/7°
SEAT POST	ALUMINIUM 27,2 x 350 mm
HEADSET	FSA NO.42/ACB:1-1/8"-1,5"
SADDLE	SELLE ROYAL 2043HRN
GRIPS	KROSS EVA

GEOMETRY

SIZE	S	M	L	XL
FS - FRAME SIZE*	20	21	22	23
ST - SEAT TUBE LENGTH**	500	530	560	590
TT - TOP TUBE LENGTH**	543	554	573	585
HT - HEAD TUBE LENGTH**	160	175	195	205
SA - SEAT TUBE ANGLE***	73,5	73,5	73	73
HA - HEAD TUBE ANGLE***	72,5	72,5	73	73
CS - CHAINSTAY LENGTH**	421	421	421	421
WB - WHEELBASE**	992	1003	1012	1024
REACH**	377	384	391	400
STACK**	560	574	595	610
BB DROP**	70	70	70	70

* dimension in inches, ** dimension in mm, *** dimension in degrees

VENTO 4.0

NEW



SKU	SIZE	COLOUR	FINISH
KRVE4Z28X20M007370	S	graphite	gloss
KRVE4Z28X21M007371	M	graphite	gloss
KRVE4Z28X22M007372	L	graphite	gloss
KRVE4Z28X23M007373	XL	graphite	gloss

GEAR RATIO 2 x 10

WHEEL DIAMETER 700C

COLOUR VARIANTS



FRAME

FRAME	ALUMINIUM SUPERLITE
FORK	CARBON
SIZES	S(20"), M(21"), L(22"), XL(23")

DRIVETRAIN

FRONT DERAILLEUR	SHIMANO TIAGRA 4700
REAR DERAILLEUR	SHIMANO TIAGRA 4700
FRONT BRAKE	TEKTRO MD C550
REAR BRAKE	TEKTRO MD C550
BRAKE LEVERS	SHIMANO TIAGRA 4700
SHIFTERS	SHIMANO TIAGRA 4700
CRANKSET	SHIMANO TIAGRA 4700
SPROCKETS	50T-34T/170 mm
BOTTOM BRACKET	SHIMANO BSA BB-RS500
CHAIN	SHIMANO HG54
CASSETTE/FREEWHEEL	SHIMANO HG500
CASSETTE/FREEWHEEL RANGE	11-25T

WHEELS

FRONT HUB	SHIMANO RS470 12 x 100
REAR HUB	SHIMANO TIAGRA RS470 12 x 142
RIMS	MACH1
TIRES	SCHWALBE LUGANO KGUARD 700 x 28C

COMPONENTS

HANDLEBAR	ALUMINIUM 420 mm 31.8
HANDLEBAR STEM	ALUMINIUM 90 mm/31.8/7°
SEAT POST	ALUMINIUM 27.2 x 350 mm
HEADSET	FSA NO.42/ACB:1-1/8"-1,5"
SADDLE	SELLE ROYAL 2043HRN
GRIPS	KROSS EVA

GEOMETRY

SIZE	S	M	L	XL
FS - FRAME SIZE*	20	21	22	23
ST - SEAT TUBE LENGTH**	500	530	560	590
TT - TOP TUBE LENGTH**	543	554	573	585
HT - HEAD TUBE LENGTH**	160	175	195	205
SA - SEAT TUBE ANGLE***	73,5	73,5	73	73
HA - HEAD TUBE ANGLE***	72,5	72,5	73	73
CS - CHAINSTAY LENGTH**	421	421	421	421
WB - WHEELBASE**	992	1003	1012	1024
REACH**	377	384	391	400
STACK**	560	574	595	610
BB DROP**	70	70	70	70

* dimension in inches, ** dimension in mm, *** dimension in degrees

VENTO DSC 4.0



SKU	SIZE	COLOUR	FINISH
KRVD4Z28X20M004528	S	ruby red-black	gloss
KRVD4Z28X21M004529	M	ruby red-black	gloss
KRVD4Z28X22M004530	L	ruby red-black	gloss
KRVD4Z28X23M004531	XL	ruby red-black	gloss

GEAR RATIO 2 x 10

WHEEL DIAMETER 700C

COLOUR VARIANTS



FRAME

FRAME	ALUMINIUM LITE
FORK	CARBON
SIZES	S(20"), M(21"), L(22"), XL(23")

DRIVETRAIN

FRONT DERAILLEUR	SHIMANO TIAGRA 4700
REAR DERAILLEUR	SHIMANO TIAGRA 4700
FRONT BRAKE	TEKTRO MD C550
REAR BRAKE	TEKTRO MD C550
BRAKE LEVERS	SHIMANO TIAGRA ST-4700
BRAKE DISCS	TEKTRO TR-140-35
SHIFTERS	SHIMANO TIAGRA 4700
CRANKSET	SHIMANO TIAGRA 4700
SPROCKETS	52T-36T/ 172,5 mm
BOTTOM BRACKET	SHIMANO BSA BB-RS500
CHAIN	SHIMANO HG54
CASSETTE/FREEWHEEL	SHIMANO GRX RX400 HG500
CASSETTE/FREEWHEEL RANGE	11-28T

WHEELS

FRONT HUB	SHIMANO RS470 12 x 100
REAR HUB	SHIMANO TIAGRA RS470 12 x 142
RIMS	ALEXRIMS ATD470 622 X 17
TIRES	SCHWALBE LUGANO II 700 x 28C

COMPONENTS

HANDLEBAR	ALUMINIUM 400 mm 31.8
HANDLEBAR STEM	ALUMINIUM 90 mm/31,8/7°
SEAT POST	ALUMINIUM 27,2 x 350 mm
HEADSET	FSA NO.42/ACB;1-1/8"-1,5"
SADDLE	SELLE ROYAL 2043HRN
GRIPS	KROSS EVA

GEOMETRY

SIZE	S	M	L	XL
FS - FRAME SIZE*	20	21	22	23
ST - SEAT TUBE LENGTH**	500	530	560	590
TT - TOP TUBE LENGTH**	543	554	573	585
HT - HEAD TUBE LENGTH**	160	175	195	205
SA - SEAT TUBE ANGLE***	73,5	73,5	73	73
HA - HEAD TUBE ANGLE***	72,5	72,5	73	73
CS - CHAINSTAY LENGTH**	421	421	421	421
WB - WHEELBASE**	992	1003	1012	1024
REACH**	377	384	391	400
STACK**	560	574	595	610
BB DROP**	70	70	70	70

* dimension in inches, ** dimension in mm, *** dimension in degrees

VENTO 2.0

NEW



SKU	SIZE	COLOUR	FINISH
KRVE2Z28X19M007365	XS	gray	gloss
KRVE2Z28X20M007366	S	gray	gloss
KRVE2Z28X21M007367	M	gray	gloss
KRVE2Z28X22M007368	L	gray	gloss
KRVE2Z28X23M007369	XL	gray	gloss
KRVE2Z28X19M004519	XS	black-red	gloss
KRVE2Z28X20M004520	S	black-red	gloss
KRVE2Z28X21M004521	M	black-red	gloss
KRVE2Z28X22M004522	L	black-red	gloss
KRVE2Z28X23M004523	XL	black-red	gloss

GEAR RATIO 2 x 8
WHEEL DIAMETER 700C
COLOUR VARIANTS



FRAME

FRAME	ALUMINIUM LITE
FORK	AL./CARBON
SIZES	XS(19"), S(20"), M(21"), L(22"), XL(23")

DRIVETRAIN

FRONT DERAILLEUR	SHIMANO CLARIS R2000
REAR DERAILLEUR	SHIMANO CLARIS R2000
FRONT BRAKE	TEKTRO R315
REAR BRAKE	TEKTRO R315
BRAKE LEVERS	SHIMANO CLARIS R2000
SHIFTERS	SHIMANO CLARIS R2000
CRANKSET	SHIMANO CLARIS R2000
SPROCKETS	50T-34T/170 mm
BOTTOM BRACKET	SHIMANO BSA BB-RS500
CHAIN	SHIMANO HG40
CASSETTE/FREEWHEEL	SHIMANO HG50
CASSETTE/FREEWHEEL RANGE	12-28T

WHEELS

FRONT HUB	SHIMANO SORA RS300
REAR HUB	SHIMANO SORA RS300
RIMS	ALEXRIMS AT470
TIRES	WANDA W3111 700 x 25C

COMPONENTS

HANDLEBAR	ALUMINIUM 400 mm 31.8
HANDLEBAR STEM	ALUMINIUM 80 mm/31.8/7°
SEAT POST	ALUMINIUM 27,2 x 350 mm
HEADSET	FSA NO.42/ACB 1-1/8"
SADDLE	SELLE ROYAL 2043HRN
GRIPS	KROSS EVA

GEOMETRY

SIZE	XS	S	M	L	XL
FS - FRAME SIZE*	19	20	21	22	23
ST - SEAT TUBE LENGTH**	470	500	530	560	590
TT - TOP TUBE LENGTH**	516	543	554	573	585
HT - HEAD TUBE LENGTH**	140	160	175	195	
SA - SEAT TUBE ANGLE***	74	73,5	73,5	73	73
HA - HEAD TUBE ANGLE***	71,5	72,5	72,5	73	73
CS - CHAINSTAY LENGTH**	415	415	415	415	415
WB - WHEELBASE**	979	992	1003	1012	1024
REACH**	362	377	384	391	400
STACK**	537	560	574	595	604
BB DROP**	70	70	70	70	70

* dimension in inches, ** dimension in mm, *** dimension in degrees

VENTO 2.0



SKU	SIZE	COLOUR	FINISH
KRVE2Z28X19M002602	XS	blue-silver	gloss
KRVE2Z28X20M002603	S	blue-silver	gloss
KRVE2Z28X21M002604	M	blue-silver	gloss
KRVE2Z28X22M002605	L	blue-silver	gloss
KRVE2Z28X23M002606	XL	blue-silver	gloss

GEAR RATIO 2 x 8
WHEEL DIAMETER 700C
COLOUR VARIANTS



FRAME

FRAME	ALUMINIUM LITE
FORK	AL./CARBON
SIZES	XS(19"), S(20"), M(21"), L(22"), XL(23")

DRIVETRAIN

FRONT DERAILLEUR	SHIMANO CLARIS R2000
REAR DERAILLEUR	SHIMANO CLARIS R2000
FRONT BRAKE	TEKTRO R315
REAR BRAKE	TEKTRO R315
BRAKE LEVERS	SHIMANO CLARIS R2000
SHIFTERS	SHIMANO CLARIS R2000
CRANKSET	SHIMANO CLARIS R2000
SPROCKETS	50T-34T/170 mm
BOTTOM BRACKET	SHIMANO BSA BB-RS500
CHAIN	SHIMANO HG40
CASSETTE/FREEWHEEL	SHIMANO CLARIS HG50
CASSETTE/FREEWHEEL RANGE	11-28T

WHEELS

FRONT HUB	SHIMANO SORA RS300
REAR HUB	SHIMANO SORA RS300
RIMS	ALEXRIMS ATD490 700C x 17
TIRES	WANDA W3111 700 x 25C

COMPONENTS

HANDLEBAR	ALUMINIUM 400 mm 31.8
HANDLEBAR STEM	ALUMINIUM 80 mm/31,8/7°
SEAT POST	ALUMINIUM 27,2 x 350 mm
HEADSET	FSA NO.42/ACB 1-1/8"
SADDLE	SELLE ROYAL 2043HRN
GRIPS	KROSS EVA

GEOMETRY

SIZE	XS	S	M	L	XL
FS - FRAME SIZE*	19	20	21	22	23
ST - SEAT TUBE LENGTH**	470	500	530	560	590
TT - TOP TUBE LENGTH**	516	543	554	573	585
HT - HEAD TUBE LENGTH**	140	160	175	195	205
SA - SEAT TUBE ANGLE***	74	73,5	73,5	73	73
HA - HEAD TUBE ANGLE***	71,5	72,5	72,5	73	73
CS - CHAINSTAY LENGTH**	415	415	415	415	415
WB - WHEELBASE**	979	992	1003	1012	1024
REACH**	362	377	384	391	400
STACK**	537	560	574	595	604
BB DROP**	70	70	70	70	70

* dimension in inches, ** dimension in mm, *** dimension in degrees

MOUNTAIN BIKES

EARTH

KROSS Earth is our most advanced mountain bike, designed in collaboration with a professional cycling team to offer exceptional performance on challenging XCO and XCM races.

Lightweight and durable frame: Earth is made from lightweight and durable carbon fibre or top-grade aluminium, allowing for weight reduction and increased stiffness. This results in improved bike control and the ability to achieve higher speeds on technical trails.

Geometry: we designed Earth to combine pedalling efficiency with confidence in tackling technical descents and manoeuvrability on narrow trails.

Efficient suspension system: each Earth is equipped with an advanced ESPS (Efficient Single Pivot Suspension) suspension system that effectively absorbs shocks and terrain irregularities, resulting in a smooth and fast off-road ride.





EARTH TE



GEAR RATIO 1 x 12

WHEEL DIAMETER 29"

COLOUR VARIANTS



SKU	SIZE	COLOUR	FINISH
KRERTE29X16M004396	S	red-black-silver	gloss
KRERTE29X17M004397	M	red-black-silver	gloss
KRERTE29X19M004398	L	red-black-silver	gloss

FRAME

FRAME	CARBON ESPS 100 mm
FORK	ROCK SHOX SID BASE RUSH
FORK TRAVEL	110 mm
TYLNY AMORTYZATOR	ROCK SHOX DELUXE ULTIMATE 165 x 45 mm
SIZES	S(16"), M(17"), L(19")

DRIVETRAIN

REAR DERAILLEUR	SHIMANO XT M8100
FRONT BRAKE	SHIMANO XT M8100
REAR BRAKE	SHIMANO XT M8110
BRAKE LEVERS	SHIMANO XT M8100
BRAKE DISCS	SHIMANO XT M8100
SHIFTERS	SHIMANO XT M8100
CRANKSET	SHIMANO XT M8100
SPROCKETS	34T/175 mm
BOTTOM BRACKET	SHIMANO PRESS FIT BB-MT800
CHAIN	SHIMANO M8100
CASSETTE/FREEWHEEL	SHIMANO DEORE XT M8100
CASSETTE/FREEWHEEL RANGE	10-51T

WHEELS

FRONT HUB	FSA AFTERBURNER I25 BOOST
REAR HUB	FSA AFTERBURNER I25 BOOST
RIMS	FSA AFTERBURNER I25
TIRES	SCHWALBE RACING RALPH EVO + RACING RAY EVO 29 x 2,25

COMPONENTS

HANDLEBAR	FSA AFTERBURNER 740 mm 31.8
HANDLEBAR STEM	FSA Afterburner 80 mm/31,8/12°
SEAT POST	KS LEV INTEGRA 125 mm (S); 150 mm (M, L)
HEADSET	FSA Orbit C-40-CF-ACB
SADDLE	FIZIK ANTARES R7
GRIPS	KROSS SILKY

GEOMETRY

SIZE	S	M	L
FS - FRAME SIZE*	16	17	19
ST - SEAT TUBE LENGTH**	400	435	470
TT - TOP TUBE LENGTH**	575	600	625
HT - HEAD TUBE LENGTH**	100	100	115
SA - SEAT TUBE ANGLE***	74	74	74
HA - HEAD TUBE ANGLE***	69	69	69
CS - CHAINSTAY LENGTH**	435	435	435
WB - WHEELBASE**	1115	1140	1165
REACH**	409	434	454
STACK**	587	587	601
BB DROP**	40	40	40

* dimension in inches, ** dimension in mm, *** dimension in degrees

EARTH 3.0



SKU	SIZE	COLOUR	FINISH
KRER3Z29X16M004407	S	green-black-silver	gloss
KRER3Z29X17M004408	M	green-black-silver	gloss
KRER3Z29X19M004409	L	green-black-silver	gloss
KRER3Z29X20M004410	XL	green-black-silver	gloss

GEAR RATIO 1 x 12

WHEEL DIAMETER 29"

COLOUR VARIANTS



FRAME

FRAME	CARBON ESPS 100 mm
FORK	ROCK SHOX REBA RLR
FORK TRAVEL	100 mm
TYLNY AMORTYZATOR	ROCK SHOX DELUXE SELECT + RL 165 x 45 mm
SIZES	S(16"), M(17"), L(19"), XL(20")

DRIVETRAIN

REAR DERAILLEUR	SRAM GX EAGLE
FRONT BRAKE	SRAM LEVEL TL
REAR BRAKE	SRAM LEVEL TL
BRAKE LEVERS	SRAM LEVEL TL
BRAKE DISCS	SRAM AVID
SHIFTERS	SRAM GX EAGLE
CRANKSET	SRAM GX EAGLE
SPROCKETS	34T/175 mm
BOTTOM BRACKET	SRAM PRESS FIT DUB
CHAIN	SRAM GX EAGLE
CASSETTE/FREEWHEEL	SRAM XG1275 EAGLE
CASSETTE/FREEWHEEL RANGE	10-52T

WHEELS

FRONT HUB	FSA AFTERBURNER I25 BOOST
REAR HUB	FSA AFTERBURNER I25 BOOST
RIMS	FSA AFTERBURNER I25
TIRES	SCHWALBE RACING RALPH EVO + RACING RAY EVO 29 x 2,25

COMPONENTS

HANDLEBAR	ALUMINIUM 740 mm 31,8
HANDLEBAR STEM	ALUMINIUM 70 mm/31,8/12°
SEAT POST	ALUMINIUM 30,4 x 350 mm
HEADSET	FSA Orbit C-40-CF-ACB
SADDLE	FIZIK ANTARES
GRIPS	KROSS SILKY

GEOMETRY

SIZE	S	M	L	XL
FS - FRAME SIZE*	16	17	19	20
ST - SEAT TUBE LENGTH**	400	435	470	500
TT - TOP TUBE LENGTH**	575	600	625	650
HT - HEAD TUBE LENGTH**	100	100	115	115
SA - SEAT TUBE ANGLE***	74	74	74	74
HA - HEAD TUBE ANGLE***	69	69	69	69
CS - CHAINSTAY LENGTH**	435	435	435	435
WB - WHEELBASE**	1115	1140	1165	1190
REACH**	409	434	454	479
STACK**	587	587	601	601
BB DROP**	40	40	40	40

* dimension in inches, ** dimension in mm, *** dimension in degrees

EARTH 3.0



SKU	SIZE	COLOUR	FINISH
KRER3Z29X16M003041	S	black-lime-silver	gloss
KRER3Z29X17M003042	M	black-lime-silver	gloss
KRER3Z29X19M003043	L	black-lime-silver	gloss
KRER3Z29X20M003044	XL	black-lime-silver	gloss

GEAR RATIO 1 x 12

WHEEL DIAMETER 29"

COLOUR VARIANTS



FRAME

FRAME	D84 CARBON SL/ ALU SUPERLITE ESPS 100 mm
FORK	ROCK SHOX REBA RLR
FORK TRAVEL	100 mm
TYLNY AMORTYZATOR	ROCK SHOX DELUXE ULTIMATE 165 x 45 mm
SIZES	S(16"), M(17"), L(19"), XL(21")

DRIVETRAIN

REAR DERAILLEUR	SHIMANO XT M8100
FRONT BRAKE	SHIMANO MT410
REAR BRAKE	SHIMANO MT410
BRAKE LEVERS	SHIMANO MT401
BRAKE DISCS	SHIMANO RT30 (180/160)
SHIFTERS	SHIMANO SLX M7100
CRANKSET	SHIMANO MT510
SPROCKETS	34T/175 mm
BOTTOM BRACKET	SHIMANO PRESS FIT BB-MT800
CHAIN	SHIMANO M7100
CASSETTE/FREEWHEEL	SHIMANO SLX M7100
CASSETTE/FREEWHEEL RANGE	10-51T

WHEELS

FRONT HUB	SHIMANO MT400 15 x 110
REAR HUB	SHIMANO MT410 12 x 148
RIMS	WTB ST I23 622 x 23
TIRES	SCHWALBE RACING RALPH PERF. + RACING RAY PERF. 29 x 2,25

COMPONENTS

HANDLEBAR	ALUMINIUM 740 mm 31.8
HANDLEBAR STEM	ALUMINIUM 70 mm/31,8/12°
SEAT POST	ALUMINIUM 30,4 x 350 mm
HEADSET	FSA Orbit C-40-CF-ACB
SADDLE	SELLE ROYAL 2043HRN
GRIPS	KROSS SILKY

GEOMETRY

SIZE	S	M	L	XL
FS - FRAME SIZE*	16	17	19	20
ST - SEAT TUBE LENGTH**	400	440	470	500
TT - TOP TUBE LENGTH**	575	600	625	650
HT - HEAD TUBE LENGTH**	100	100	115	115
SA - SEAT TUBE ANGLE***	74	74	74	74
HA - HEAD TUBE ANGLE***	68,5	68,5	69	69
CS - CHAINSTAY LENGTH**	435	435	435	435
WB - WHEELBASE**	1115	1140	1165	1190
REACH**	409	434	454	479
STACK**	589	589	601	601
BB DROP**	40	40	40	40

* dimension in inches, ** dimension in mm, *** dimension in degrees

EARTH 2.0



SKU	SIZE	COLOUR	FINISH
KRER2Z29X17M004404	M	turquoise-black-silver	gloss
KRER2Z29X19M004405	L	turquoise-black-silver	gloss
KRER2Z29X20M004406	XL	turquoise-black-silver	gloss

GEAR RATIO 1 x 12

WHEEL DIAMETER 29"

COLOUR VARIANTS



FRAME

FRAME	ALUMINIUM ESPTS 100 mm
FORK	ROCK SHOX RECON SILVER RL
FORK TRAVEL	100 mm
TYLNY AMORTYZATOR	ROCK SHOX DELUXE SELECT + RL 165 x 45 mm
SIZES	M(17"), L(19"), XL(21")

DRIVETRAIN

REAR DERAILLEUR	SHIMANO SLX M7100
FRONT BRAKE	SHIMANO MT410
REAR BRAKE	SHIMANO MT410
BRAKE LEVERS	SHIMANO MT401
BRAKE DISCS	SHIMANO RT10 (180/160)
SHIFTERS	SHIMANO SLX M7100
CRANKSET	SHIMANO MT510
SPROCKETS	34T/175 mm
BOTTOM BRACKET	SHIMANO BSA BB52
CHAIN	SHIMANO CN-M7100
CASSETTE/FREEWHEEL	SHIMANO SLX M7100
CASSETTE/FREEWHEEL RANGE	10-51T

WHEELS

FRONT HUB	SHIMANO MT400-B
REAR HUB	SHIMANO MT410 12 x 148
RIMS	WTB ST I23
TIRES	SCHWALBE RACING RALPH PERF. + RACING RAY PERF. 29 x 2,25

COMPONENTS

HANDLEBAR	ALUMINIUM 740 mm 31.8
HANDLEBAR STEM	ALUMINIUM 70 mm/31,8/12°
SEAT POST	ALUMINIUM 30,4 x 350 mm
HEADSET	ALUMINIUM
SADDLE	SELLE ROYAL ERGO MAN
GRIPS	KROSS SILKY

GEOMETRY

SIZE	M	L	XL
FS - FRAME SIZE*	17	19	21
ST - SEAT TUBE LENGTH**	435	470	495
TT - TOP TUBE LENGTH**	600	625	650
HT - HEAD TUBE LENGTH**	100	115	115
SA - SEAT TUBE ANGLE***	74,3	74,2	74,2
HA - HEAD TUBE ANGLE***	68,5	68,5	68,5
CS - CHAINSTAY LENGTH**	435	435	435
WB - WHEELBASE**	1140	1165	1190
REACH**	434	454	479
STACK**	587	601	601
BB DROP**	40	40	40

* dimension in inches, ** dimension in mm, *** dimension in degrees

EARTH 2.0



SKU	SIZE	COLOUR	FINISH
KRER2Z29X16M005582	S	turquoise-silver-black	gloss
KRER2Z29X17M005583	M	turquoise-silver-black	gloss
KRER2Z29X19M005584	L	turquoise-silver-black	gloss
KRER2Z29X20M005585	XL	turquoise-silver-black	gloss

GEAR RATIO 1 x 12

WHEEL DIAMETER 29"

COLOUR VARIANTS



FRAME

FRAME	ALUMINIUM ESPTS 100 mm
FORK	ROCK SHOX REBA RL
FORK TRAVEL	100 mm
TYLNY AMORTYZATOR	ROCK SHOX DELUXE SELECT + RL 165 x 45 mm
SIZES	S(16"), M(17"), L(19"), XL(21")

DRIVETRAIN

REAR DERAILLEUR	SHIMANO SLX M7100
FRONT BRAKE	SHIMANO MT410
REAR BRAKE	SHIMANO MT410
BRAKE LEVERS	SHIMANO MT401
BRAKE DISCS	SHIMANO RT10 (180/160)
SHIFTERS	SHIMANO SLX M7100
CRANKSET	GAMMA PRO 1X MEGAEXO
SPROCKETS	34T/175 mm
BOTTOM BRACKET	MEGAEXO BB ø24 BB7100
CHAIN	SHIMANO M7100
CASSETTE/FREEWHEEL	SHIMANO SLX M7100
CASSETTE/FREEWHEEL RANGE	10-51T

WHEELS

FRONT HUB	GL-B93F-B/CL-X15 32H
REAR HUB	GL-B93R-SB/CL-X12 MS 32H
RIMS	WTB ST I23 622 x 23
TIRES	SCHWALBE RACING RALPH PERF. + RACING RAY PERF. 29 x 2,25

COMPONENTS

HANDLEBAR	ALUMINIUM 740 mm 31.8
HANDLEBAR STEM	ALUMINIUM 70 mm/31,8/12°
SEAT POST	ALUMINIUM 30,4 x 350 mm
HEADSET	FP-H856B2,1-1/8"-1.5"
SADDLE	SELLE ROYAL ERGO MAN
GRIPS	KROSS SILKY

GEOMETRY

SIZE	S	M	L	XL
FS - FRAME SIZE*	16	17	19	21
ST - SEAT TUBE LENGTH**	400	435	470	495
TT - TOP TUBE LENGTH**	575	600	625	650
HT - HEAD TUBE LENGTH**	100	100	115	115
SA - SEAT TUBE ANGLE***	74,3	74,3	74,2	74,2
HA - HEAD TUBE ANGLE***	68,5	68,5	68,5	68,5
CS - CHAINSTAY LENGTH**	435	435	435	435
WB - WHEELBASE**	1115	1140	1165	1190
REACH**	409	434	454	479
STACK**	587	587	601	601
BB DROP**	40	40	40	40

* dimension in inches, ** dimension in mm, *** dimension in degrees

EARTH 1.0



SKU	SIZE	COLOUR	FINISH
KRER1Z29X16M004399	S	graphite-black-silver	gloss
KRER1Z29X17M004400	M	graphite-black-silver	gloss
KRER1Z29X19M004401	L	graphite-black-silver	gloss
KRER1Z29X20M004402	XL	graphite-black-silver	gloss

GEAR RATIO 1 x 11

WHEEL DIAMETER 29"

COLOUR VARIANTS



FRAME

FRAME	ALUMINIUM ESPS 100 mm
FORK	SR SUNTOUR XCR 32 RLR AIR
FORK TRAVEL	100 mm
TYLNY AMORTYZATOR	SR SUNTOUR EDGE R 165 x 45 mm
SIZES	S(16"), M(17"), L(19"), XL(21")

DRIVETRAIN

REAR DERAILLEUR	SHIMANO DEORE M5100
FRONT BRAKE	SHIMANO MT200
REAR BRAKE	SHIMANO MT200
BRAKE LEVERS	SHIMANO MT200
BRAKE DISCS	SHIMANO RT10 (180/160)
SHIFTERS	SHIMANO DEORE M5100
CRANKSET	SHIMANO DEORE M5100
SPROCKETS	32T/175 mm
BOTTOM BRACKET	SHIMANO BSA BB52
CHAIN	SHIMANO HG6001
CASSETTE/FREEWHEEL	SHIMANO DEORE M5100
CASSETTE/FREEWHEEL RANGE	11-51T

WHEELS

FRONT HUB	SHIMANO MT400-B
REAR HUB	SHIMANO MT400 12 x 148
RIMS	KROSS
TIRES	SCHWALBE RAPID ROB 29 x 2,25

COMPONENTS

HANDLEBAR	ALUMINIUM 740 mm 31,8
HANDLEBAR STEM	ALUMINIUM 70 mm/31,8/12
SEAT POST	ALUMINIUM 30,4 x 350 mm
HEADSET	ALUMINIUM
SADDLE	SELLE ROYAL ERGO MAN
GRIPS	KROSS SILKY

GEOMETRY

SIZE	S	M	L	XL
FS - FRAME SIZE*	16	17	19	21
ST - SEAT TUBE LENGTH**	400	435	470	495
TT - TOP TUBE LENGTH**	575	600	625	650
HT - HEAD TUBE LENGTH**	100	100	115	115
SA - SEAT TUBE ANGLE***	74,3	74,3	74,2	74,2
HA - HEAD TUBE ANGLE***	68,5	68,5	68,5	68,5
CS - CHAINSTAY LENGTH**	435	435	435	435
WB - WHEELBASE**	1115	1140	1165	1190
REACH**	409	434	454	479
STACK**	587	587	601	601
BB DROP**	40	40	40	40

* dimension in inches, ** dimension in mm, *** dimension in degrees

EARTH 1.0



SKU	SIZE	COLOUR	FINISH
KRER1Z29X16M005578	S	graphite-black-silver	gloss
KRER1Z29X17M005579	M	graphite-black-silver	gloss
KRER1Z29X19M005580	L	graphite-black-silver	gloss
KRER1Z29X20M005581	XL	graphite-black-silver	gloss

GEAR RATIO 1 x 11

WHEEL DIAMETER 29"

COLOUR VARIANTS



FRAME

FRAME	ALUMINIUM ESPS 100 mm
FORK	SR SUNTOUR XCR 32 RLR AIR
FORK TRAVEL	100 mm
TYLNY AMORTYZATOR	SR SUNTOUR EDGE R 165 x 45 mm
SIZES	S(16"), M(17"), L(19"), XL(21")

DRIVETRAIN

REAR DERAILLEUR	SHIMANO DEORE M5100
FRONT BRAKE	POWER BH-M960
REAR BRAKE	POWER BH-M960
BRAKE LEVERS	POWER BH-M960
BRAKE DISCS	SHIMANO RT10 (180/160)
SHIFTERS	SHIMANO DEORE M5100
CRANKSET	GAMMA PRO 1X MEGAEXO
SPROCKETS	34T/170 mm
BOTTOM BRACKET	MEGAEXO BB ø24 BB7100
CHAIN	SHIMANO HG601
CASSETTE/FREEWHEEL	SHIMANO DEORE M5100
CASSETTE/FREEWHEEL RANGE	11-51T

WHEELS

FRONT HUB	GL-B93F-B/CL-X15 32H
REAR HUB	GL-B74R-SB/CL-X12 32H
RIMS	KROSS
TIRES	SCHWALBE RAPID ROB 29 x 2,25

COMPONENTS

HANDLEBAR	ALUMINIUM 740 mm 31.8
HANDLEBAR STEM	ALUMINIUM 70 mm/31.8/12°
SEAT POST	ALUMINIUM 30,4 x 350 mm
HEADSET	FP-H856B2,1-1/8"-1.5"
SADDLE	SELLE ROYAL ERGO MAN
GRIPS	KROSS SILKY

GEOMETRY

SIZE	S	M	L	XL
FS - FRAME SIZE*	16	17	19	21
ST - SEAT TUBE LENGTH**	400	435	470	495
TT - TOP TUBE LENGTH**	575	600	625	650
HT - HEAD TUBE LENGTH**	100	100	115	115
SA - SEAT TUBE ANGLE***	74,3	74,3	74,2	74,2
HA - HEAD TUBE ANGLE***	68,5	68,5	68,5	68,5
CS - CHAINSTAY LENGTH**	435	435	435	435
WB - WHEELBASE**	1115	1140	1165	1190
REACH**	409	434	454	479
STACK**	587	587	601	601
BB DROP**	40	40	40	40

* dimension in inches, ** dimension in mm, *** dimension in degrees



MTB

LEVEL

Level with a carbon frame is our mountain bikes line designed in collaboration with a professional cycling team, aligning with their pursuit of the highest performance, lightness, and desired stiffness for marathon routes and XCO races. It's a line that has gained recognition among both athletes and enthusiasts.

Level 10.0, Level 8.0, Level 8.0 FEMI LINE and Level 7.0 feature a lightweight and stiff frame made of carbon fiber, allowing for the minimization of bike weight while increasing stiffness, all while maintaining comfort.

Level 12.0 and Level 11.0 are built on a frame that replicates Maja Włoszczowska's frame from the 2020 Tokyo Olympics. It boasts uncompromising racing geometry, aiding in dynamic navigation over technical obstacles on the track.





LEVEL 12.0

NEW



GEAR RATIO 1 x 12

WHEEL DIAMETER 29"

COLOUR VARIANTS



SKU	SIZE	COLOUR	FINISH
KRLV1229X17M007034	M	grey-green	gloss
KRLV1229X19M007035	L	grey-green	gloss

FRAME

FRAME	CARBON
FORK	ROCK SHOX SID SELECT RL
FORK TRAVEL	100 mm
SIZES	M(17"), L(19")

DRIVETRAIN

REAR DERAILLEUR	SRAM GX LUNAR EAGLE
FRONT BRAKE	SRAM LEVEL TL
REAR BRAKE	SRAM LEVEL TL
BRAKE LEVERS	SRAM LEVEL TL
BRAKE DISCS	SRAM CENTERLINE-A2 160 CL
SHIFTERS	SRAM GX EAGLE TRIGGER
CRANKSET	SRAM GX LUNAR EAGLE
SPROCKETS	34T/175 mm
BOTTOM BRACKET	SRAM DUB PF
CHAIN	SRAM GX
CASSETTE/FREEWHEEL	SRAM GX EAGLE
CASSETTE/FREEWHEEL RANGE	10-52T

WHEELS

FRONT HUB	FSA AFTERBURNER 15 x 110
REAR HUB	FSA AFTERBURNER 12 x 148
RIMS	FSA AFTERBURNER
TIRES	SCHWALBE RACING RALPH PERF. + RACING RAY PERF. 29 x 2,25

COMPONENTS

HANDLEBAR	ALUMINIUM 720 mm 31.8
HANDLEBAR STEM	ALUMINIUM 60 mm/31,8/12°
SEAT POST	ALUMINIUM 27,2 x 350 mm
HEADSET	FSA ORBIT C-40-ACB NO.42
SADDLE	FIZIK ARGOVENTO R5
GRIPS	PROPALM SILKY

GEOMETRY

SIZE	M	L
FS - FRAME SIZE*	18	19
ST - SEAT TUBE LENGTH**	440	470
TT - TOP TUBE LENGTH**	597	621
HT - HEAD TUBE LENGTH**	100	110
SA - SEAT TUBE ANGLE***	74	74
HA - HEAD TUBE ANGLE***	69	69
CS - CHAINSTAY LENGTH**	430	430
WB - WHEELBASE**	1113	1138
REACH**	423	444
STACK**	608	617
BB DROP**	60	60

* dimension in inches, ** dimension in mm, *** dimension in degrees

LEVEL 12.0



SKU	SIZE	COLOUR	FINISH
KRLV1229X16M002408	S	grey-graphite	gloss
KRLV1229X18M002409	M	grey-graphite	gloss
KRLV1229X19M002410	L	grey-graphite	gloss

GEAR RATIO 1 x 12

WHEEL DIAMETER 29"

COLOUR VARIANTS



FRAME

FRAME	CARBON
FORK	ROCK SHOX SID SL SELECT RL
FORK TRAVEL	100 mm
SIZES	S(16"), M(17"), L(19")

DRIVETRAIN

REAR DERAILLEUR	SHIMANO XT RD-M8100 12s
FRONT BRAKE	SHIMANO MT500
REAR BRAKE	SHIMANO MT500
BRAKE LEVERS	SHIMANO MT501
BRAKE DISCS	SHIMANO (160 mm)
SHIFTERS	SHIMANO SLX M7100-12s
CRANKSET	SHIMANO M7100 SLX
SPROCKETS	34T/175 mm
BOTTOM BRACKET	SHIMANO BB-MT500
CHAIN	SHIMANO CN-M7100
CASSETTE/FREEWHEEL	CS-M7100-12, SLX 10-51T
CASSETTE/FREEWHEEL RANGE	10-51T

WHEELS

FRONT HUB	DT SWISS 110 x 15
REAR HUB	DT SWISS 148 x 12
RIMS	DT SWISS X 1900 25mm
TIRES	SCHWALBE RACING RAY 29 x 2,25

COMPONENTS

HANDLEBAR	ALUMINIUM 720 mm 31.8
HANDLEBAR STEM	ALUMINIUM 60 mm/31,8/12°
SEAT POST	ALUMINIUM 27,2 x 350 mm
HEADSET	FSA ORBIT C-40-ACB NO.42
SADDLE	SELLE ROYAL 2043HRN
GRIPS	KROSS SCALE

GEOMETRY

SIZE	S	M	L
FS - FRAME SIZE*	16	18	19
ST - SEAT TUBE LENGTH**	403	440	470
TT - TOP TUBE LENGTH**	570	590	615
HT - HEAD TUBE LENGTH**	95	100	110
SA - SEAT TUBE ANGLE***	74	74	74
HA - HEAD TUBE ANGLE***	69	69	69
CS - CHAINSTAY LENGTH**	434	434	434
WB - WHEELBASE**	1086	1106	1132
REACH**	397	416	438
STACK**	602	606	616
BB DROP**	57	57	57

* dimension in inches, ** dimension in mm, *** dimension in degrees

LEVEL 12.0



GEAR RATIO 1 x 12

WHEEL DIAMETER 29"

COLOUR VARIANTS



SKU	SIZE	COLOUR	FINISH
KRLV1229X16M005575	S	grey-graphite	gloss
KRLV1229X17M005576	M	grey-graphite	gloss
KRLV1229X19M005577	L	grey-graphite	gloss

FRAME

FRAME	CARBON
FORK	ROCK SHOX SID SELECT RL
FORK TRAVEL	100 mm
SIZES	S(16"), M(17"), L(19")

DRIVETRAIN

REAR DERAILLEUR	SHIMANO XT M8100
FRONT BRAKE	SHIMANO MT500
REAR BRAKE	SHIMANO MT500
BRAKE LEVERS	SHIMANO MT501
BRAKE DISCS	SHIMANO (160 mm)
SHIFTERS	SHIMANO SLX M7100-12s
CRANKSET	SHIMANO SLX M7100
SPROCKETS	34T/175 mm
BOTTOM BRACKET	SHIMANO BB-MT500
CHAIN	SHIMANO M7100
CASSETTE/FREEWHEEL	SHIMANO SLX M7100
CASSETTE/FREEWHEEL RANGE	10-51T

WHEELS

FRONT HUB	FSA 15 x 110
REAR HUB	FSA 12 x 148 mm Mircorspline
RIMS	FSA I30
TIRES	SCHWALBE RACING RALPH 29 x 2,25

COMPONENTS

HANDLEBAR	ALUMINIUM 720 mm 31.8
HANDLEBAR STEM	ALUMINIUM 60 mm/31,8/12°
SEAT POST	ALUMINIUM 27,2 x 350 mm
HEADSET	FSA ORBIT C-40-ACB NO.42
SADDLE	FIZIK ARGOVENTO R5
GRIPS	KROSS SCALE

GEOMETRY

SIZE	S	M	L
FS - FRAME SIZE*	16	18	19
ST - SEAT TUBE LENGTH**	403	440	470
TT - TOP TUBE LENGTH**	570	590	615
HT - HEAD TUBE LENGTH**	95	100	110
SA - SEAT TUBE ANGLE***	74	74	74
HA - HEAD TUBE ANGLE***	69	69	69
CS - CHAINSTAY LENGTH**	434	434	434
WB - WHEELBASE**	1086	1106	1132
REACH**	397	416	438
STACK**	602	606	616
BB DROP**	57	57	57

* dimension in inches, ** dimension in mm, *** dimension in degrees

LEVEL 11.0

NEW



SKU	SIZE	COLOUR	FINISH
KRLV1129X16M007030	S	navy blue-beige	gloss
KRLV1129X17M007031	M	navy blue-beige	gloss
KRLV1129X19M007032	L	navy blue-beige	gloss

GEAR RATIO 1 x 12

WHEEL DIAMETER 29"

COLOUR VARIANTS



FRAME

FRAME	CARBON
FORK	ROCK SHOX REBA RLR
FORK TRAVEL	100 mm
SIZES	S(16"), M(17"), L(19")

DRIVETRAIN

REAR DERAILLEUR	SHIMANO XT RD-M8100 12S
FRONT BRAKE	SHIMANO M6100
REAR BRAKE	SHIMANO M6100
BRAKE LEVERS	SHIMANO M6100
BRAKE DISCS	SHIMANO SM-RT70
SHIFTERS	SHIMANO SLX M7100-12s
CRANKSET	SHIMANO FC-M7100 SLX
SPROCKETS	34T/175 mm
BOTTOM BRACKET	SHIMANO BB-MT800-PA
CHAIN	SHIMANO CN-M7100
CASSETTE/FREEWHEEL	CS-M7100-12, SLX 10-51T
CASSETTE/FREEWHEEL RANGE	10-51T

WHEELS

FRONT HUB	FSA AFTERBURNER 15 x 110
REAR HUB	FSA AFTERBURNER 12 x 148
RIMS	FSA AFTERBURNER 125
TIRES	SCHWALBE RACING RALPH PERF. + RACING RAY PERF. 29 x 2,25

COMPONENTS

HANDLEBAR	ALUMINIUM 720 mm 31.8
HANDLEBAR STEM	ALUMINIUM 70 mm/31,8/12°
SEAT POST	ALUMINIUM 27,2 x 350 mm
HEADSET	FSA ORBIT C-40-ACB NO.42
SADDLE	SELLE ROYAL ERGO MAN
GRIPS	PROPALM SILKY

GEOMETRY

SIZE	S	M	L
FS - FRAME SIZE*	16	18	19
ST - SEAT TUBE LENGTH**	403	440	470
TT - TOP TUBE LENGTH**	573	597	621
HT - HEAD TUBE LENGTH**	95	100	110
SA - SEAT TUBE ANGLE***	74	74	74
HA - HEAD TUBE ANGLE***	69	69	69
CS - CHAINSTAY LENGTH**	430	430	430
WB - WHEELBASE**	1089	1113	1138
REACH**	400	423	444
STACK**	603	608	617
BB DROP**	60	60	60

* dimension in inches, ** dimension in mm, *** dimension in degrees

LEVEL 11.0



SKU	SIZE	COLOUR	FINISH
KRLV1129X16M002404	S	blue-white	gloss
KRLV1129X17M002405	M	blue-white	gloss
KRLV1129X19M002406	L	blue-white	gloss

GEAR RATIO 1 x 12

WHEEL DIAMETER 29"

COLOUR VARIANTS



FRAME

FRAME	CARBON
FORK	ROCK SHOX REBA RLR
FORK TRAVEL	100 mm
SIZES	S(16"), M(17"), L(19")

DRIVETRAIN

REAR DERAILLEUR	SHIMANO XT M8100
FRONT BRAKE	SHIMANO MT500
REAR BRAKE	SHIMANO MT500
BRAKE LEVERS	SHIMANO MT501
BRAKE DISCS	SHIMANO (160 mm)
SHIFTERS	SHIMANO SLX M7100-12s
CRANKSET	SHIMANO MT510-1
SPROCKETS	34T/175 mm
BOTTOM BRACKET	SHIMANO BB-MT500
CHAIN	SHIMANO M7100
CASSETTE/FREEWHEEL	SHIMANO SLX M7100
CASSETTE/FREEWHEEL RANGE	10-51T

WHEELS

FRONT HUB	MT400-B
REAR HUB	MT410-B MICRO SPLINE
RIMS	WTB ST I23 622 x 23
TIRES	SCHWALBE RAPID ROB 29 x 2,25

COMPONENTS

HANDLEBAR	ALUMINIUM 720 mm 31.8
HANDLEBAR STEM	ALUMINIUM 70 mm/31,8/12°
SEAT POST	ALUMINIUM 27,2 x 350 mm
HEADSET	FSA ORBIT C-40-ACB NO.42
SADDLE	SELLE ROYAL ERGO MAN
GRIPS	KROSS SCALE

GEOMETRY

SIZE	S	M	L
FS - FRAME SIZE*	16	17	19
ST - SEAT TUBE LENGTH**	403	440	470
TT - TOP TUBE LENGTH**	573	597	621
HT - HEAD TUBE LENGTH**	95	100	110
SA - SEAT TUBE ANGLE***	74	74	74
HA - HEAD TUBE ANGLE***	69	69	69
CS - CHAINSTAY LENGTH**	430	430	430
WB - WHEELBASE**	1089	1113	1138
REACH**	400	423	444
STACK**	603	608	617
BB DROP**	60	60	60

* dimension in inches, ** dimension in mm, *** dimension in degrees

LEVEL 10.0

NEW



SKU	SIZE	COLOUR	FINISH
KRLV1029X16M007026	S	burgundy-red	gloss
KRLV1029X17M007027	M	burgundy-red	gloss
KRLV1029X19M007028	L	burgundy-red	gloss
KRLV1029X20M007029	XL	burgundy-red	gloss

GEAR RATIO 1 x 12

WHEEL DIAMETER 29"

COLOUR VARIANTS



FRAME

FRAME	CARBON
FORK	ROCK SHOX REBA RL
FORK TRAVEL	100 mm
SIZES	S(16"), M(17"), L(19"), XL(20")

DRIVETRAIN

REAR DERAILLEUR	SHIMANO SLX M7100
FRONT BRAKE	SHIMANO MT200
REAR BRAKE	SHIMANO MT200
BRAKE LEVERS	SHIMANO MT201
BRAKE DISCS	SHIMANO RT30 160 CL
SHIFTERS	SHIMANO SLX M7100
CRANKSET	SHIMANO FC-MT610
SPROCKETS	34T/170 mm
BOTTOM BRACKET	SHIMANO BB-MT501
CHAIN	SHIMANO M7100
CASSETTE/FREEWHEEL	SHIMANO SLX M7100
CASSETTE/FREEWHEEL RANGE	10-51T

WHEELS

FRONT HUB	SHIMANO MT400
REAR HUB	SHIMANO MT410
RIMS	WTB ST I25 622 x 25
TIRES	SCHWALBE RAPID ROB 2,25 (PRZÓD) /2,1 (TYŁ)

COMPONENTS

HANDLEBAR	ALUMINIUM 720 mm 31.8
HANDLEBAR STEM	ALUMINIUM 70 mm/31,8/17°
SEAT POST	ALUMINIUM 27,2 x 350 mm
HEADSET	FSA ORBIT C-40-ACB NO.42
SADDLE	SELLE ROYAL 2043HRN
GRIPS	PROPALM SILKY

GEOMETRY

SIZE	S	M	L	XL
FS - FRAME SIZE*	16	17	19	20
ST - SEAT TUBE LENGTH**	403	440	470	520
TT - TOP TUBE LENGTH**	570	590	615	630
HT - HEAD TUBE LENGTH**	95	100	110	120
SA - SEAT TUBE ANGLE***	74	74	74	74
HA - HEAD TUBE ANGLE***	69	69	69	69
CS - CHAINSTAY LENGTH**	434	434	434	434
WB - WHEELBASE**	1086	1106	1132	1148
REACH**	397	416	438	451
STACK**	602	606	616	625
BB DROP**	57	57	57	57

* dimension in inches, ** dimension in mm, *** dimension in degrees

LEVEL 10.0



GEAR RATIO 1 x 12

WHEEL DIAMETER 29"

COLOUR VARIANTS



SKU	SIZE	COLOUR	FINISH
KRLV1029X17M003659	M	black-white	gloss

FRAME

FRAME	CARBON NO.2
FORK	ROCK SHOX REBA RL
FORK TRAVEL	100 mm
SIZES	M(17")

DRIVETRAIN

FRONT DERAILLEUR	
REAR DERAILLEUR	SHIMANO SLX M7100
FRONT BRAKE	SHIMANO MT200
REAR BRAKE	SHIMANO MT200
BRAKE LEVERS	SHIMANO MT200
BRAKE DISCS	SHIMANO (160 mm)
SHIFTERS	SHIMANO SLX M7100-12s
CRANKSET	PROWHEEL MPC-CR094S-TT
SPROCKETS	32T/175 mm
BOTTOM BRACKET	SHIMANO BSA BB52
CHAIN	SHIMANO M7100
CASSETTE/FREEWHEEL	SHIMANO SLX M7100
CASSETTE/FREEWHEEL RANGE	10-51T

WHEELS

FRONT HUB	MT400-B
REAR HUB	MT410-B MICRO SPLINE
RIMS	WTB ST I23 622 x 23
TIRES	SCHWALBE RAPID ROB 29 x 2,25

COMPONENTS

HANDLEBAR	ALUMINIUM 720 mm 31.8
HANDLEBAR STEM	ALUMINIUM 70 mm/31.8/17°
SEAT POST	ALUMINIUM 27,2 x 350 mm
HEADSET	FSA ORBIT C-40-ACB NO.42
SADDLE	SELLE ROYAL 2043HRN
GRIPS	KROSS SCALE

GEOMETRY

SIZE	M
FS - FRAME SIZE*	17
ST - SEAT TUBE LENGTH**	440
TT - TOP TUBE LENGTH**	590
HT - HEAD TUBE LENGTH**	100
SA - SEAT TUBE ANGLE***	74
HA - HEAD TUBE ANGLE***	69
CS - CHAINSTAY LENGTH**	434
WB - WHEELBASE**	1106
REACH**	416
STACK**	606
BB DROP**	57

* dimension in inches, ** dimension in mm, *** dimension in degrees

LEVEL 10.0



SKU	SIZE	COLOUR	FINISH
KRLV1029X16M005568	S	black-white	gloss
KRLV1029X17M005569	M	black-white	gloss
KRLV1029X19M005570	L	black-white	gloss
KRLV1029X20M005571	XL	black-white	gloss

GEAR RATIO 1 x 12

WHEEL DIAMETER 29"

COLOUR VARIANTS



FRAME

FRAME	CARBON NO.2
FORK	ROCK SHOX REBA RL
FORK TRAVEL	100 mm
SIZES	S(16"), M(17"), L(19"), XL(20"), XXL(22")

DRIVETRAIN

REAR DERAILLEUR	SHIMANO SLX M7100
FRONT BRAKE	SHIMANO MT200
REAR BRAKE	SHIMANO MT200
BRAKE LEVERS	SHIMANO MT200
BRAKE DISCS	SHIMANO (160 mm)
SHIFTERS	SHIMANO SLX M7100-12s
CRANKSET	SHIMANO MT510-1
SPROCKETS	34T/170 mm
BOTTOM BRACKET	MEGAEXO BB Ø24 BB7100
CHAIN	SHIMANO M7100
CASSETTE/FREEWHEEL	SHIMANO SLX M7100
CASSETTE/FREEWHEEL RANGE	10-51T

WHEELS

FRONT HUB	GL-B93F-B/CL-X15 32H
REAR HUB	GL-B93R-SB/CL-X12 MS 32H
RIMS	WTB ST I23 622 x 23
TIRES	SCHWALBE RAPID ROB 29 x 2,25

COMPONENTS

HANDLEBAR	ALUMINIUM 720 mm 31.8
HANDLEBAR STEM	ALUMINIUM 70 mm/31,8/17°
SEAT POST	ALUMINIUM 27,2 x 350 mm
HEADSET	FSA ORBIT C-40-ACB NO.42
SADDLE	SELLE ROYAL 2043HRN
GRIPS	KROSS SCALE

GEOMETRY

SIZE	M	L	XL
FS - FRAME SIZE*	17	19	20
ST - SEAT TUBE LENGTH**	440	470	520
TT - TOP TUBE LENGTH**	590	615	630
HT - HEAD TUBE LENGTH**	100	110	120
SA - SEAT TUBE ANGLE***	74	74	74
HA - HEAD TUBE ANGLE***	69	69	69
CS - CHAINSTAY LENGTH**	434	434	434
WB - WHEELBASE**	1106	1132	1148
REACH**	416	438	451
STACK**	606	616	625
BB DROP**	57	57	57

* dimension in inches, ** dimension in mm, *** dimension in degrees

LEVEL 8.0

NEW



SKU	SIZE	COLOUR	FINISH
KRLV8Z29X16M007205	S	grey-maritime	gloss
KRLV8Z29X17M007206	M	grey-maritime	gloss
KRLV8Z29X19M007207	L	grey-maritime	gloss
KRLV8Z29X20M007208	XL	grey-maritime	gloss

GEAR RATIO 1 x 12

WHEEL DIAMETER 29"

COLOUR VARIANTS



FRAME

FRAME	CARBON
FORK	ROCK SHOX RECON SILVER RL
FORK TRAVEL	100 mm
SIZES	S(16"), M(17"), L(19"), XL(20")

DRIVETRAIN

REAR DERAILLEUR	SHIMANO DEORE M6100
FRONT BRAKE	SHIMANO MT200
REAR BRAKE	SHIMANO MT200
BRAKE LEVERS	SHIMANO MT200
BRAKE DISCS	SHIMANO RT10 160 CL
SHIFTERS	SHIMANO DEORE M6100
CRANKSET	SHIMANO FC-MT510
SPROCKETS	34T/170 mm
BOTTOM BRACKET	SHIMANO BB-MT501
CHAIN	SHIMANO M6100
CASSETTE/FREEWHEEL	SHIMANO DEORE M6100
CASSETTE/FREEWHEEL RANGE	10-51T

WHEELS

FRONT HUB	SHIMANO MT400
REAR HUB	SHIMANO MT410
RIMS	KROSS ALUMINIUM 622 x 25
TIRES	SCHWALBE RAPID ROB 2,25 (PRZÓD) /2,1 (TYŁ)

COMPONENTS

HANDLEBAR	ALUMINIUM 720 mm 31.8
HANDLEBAR STEM	ALUMINIUM 60 mm/31,8/12°
SEAT POST	ALUMINIUM 27,2 x 350 mm
HEADSET	FSA ORBIT C-40-ACB NO.42
SADDLE	SELLE ROYAL ERGO MAN
GRIPS	PROPALM SILKY

GEOMETRY

SIZE	S	M	L	XL
FS - FRAME SIZE*	16	17	19	20
ST - SEAT TUBE LENGTH**	403	440	470	520
TT - TOP TUBE LENGTH**	570	590	615	630
HT - HEAD TUBE LENGTH**	95	100	110	120
SA - SEAT TUBE ANGLE***	74	74	74	74
HA - HEAD TUBE ANGLE***	69	69	69	69
CS - CHAINSTAY LENGTH**	434	434	434	434
WB - WHEELBASE**	1086	1106	1132	1148
REACH**	397	416	438	451
STACK**	602	606	616	625
BB DROP**	57	57	57	57

* dimension in inches, ** dimension in mm, *** dimension in degrees

LEVEL 8.0

NEW



GEAR RATIO 1 x 12

WHEEL DIAMETER 29"

COLOUR VARIANTS



SKU	SIZE	COLOUR	FINISH
KRLV8Z29X16W007077	DS	grey-blue	gloss
KRLV8Z29X17W007078	DM	grey-blue	gloss

FRAME

FRAME	CARBON
FORK	ROCK SHOX RECON SILVER RL
FORK TRAVEL	100 mm
SIZES	DS(16"), DM(17")

DRIVETRAIN

REAR DERAILLEUR	SHIMANO DEORE M6100
FRONT BRAKE	SHIMANO MT200
REAR BRAKE	SHIMANO MT200
BRAKE LEVERS	SHIMANO MT200
BRAKE DISCS	SHIMANO RT10 160 CL
SHIFTERS	SHIMANO DEORE M6100
CRANKSET	SHIMANO FC-MT510
SPROCKETS	34T/170 mm
BOTTOM BRACKET	SHIMANO BB-MT501
CHAIN	SHIMANO M6100
CASSETTE/FREEWHEEL	SHIMANO DEORE M6100
CASSETTE/FREEWHEEL RANGE	10-51T

WHEELS

FRONT HUB	SHIMANO MT400
REAR HUB	SHIMANO DEORE MT410
RIMS	KROSS ALUMINIUM 622 x 25
TIRES	SCHWALBE RAPID ROB 2,25 x 2,1

COMPONENTS

HANDLEBAR	ALUMINIUM 720 mm 31.8
HANDLEBAR STEM	ALUMINIUM 60 mm/31,8/12°
SEAT POST	ALUMINIUM 27,2 x 350 mm
HEADSET	FSA ORBIT C-40-ACB NO.42
SADDLE	SELLE ROYAL ERGO MAN
GRIPS	PROPALM SILKY

GEOMETRY

SIZE	DS	DM
FS - FRAME SIZE*	16	17
ST - SEAT TUBE LENGTH**	403	440
TT - TOP TUBE LENGTH**	570	590
HT - HEAD TUBE LENGTH**	95	100
SA - SEAT TUBE ANGLE***	74	74
HA - HEAD TUBE ANGLE***	69	69
CS - CHAINSTAY LENGTH**	434	434
WB - WHEELBASE**	1086	1106
REACH**	397	416
STACK**	602	606
BB DROP**	57	57

* dimension in inches, ** dimension in mm, *** dimension in degrees

LEVEL 8.0



SKU	SIZE	COLOUR	FINISH
KRLV8Z29X16M003666	S	grey-silver	gloss
KRLV8Z29X17M003667	M	grey-silver	gloss
KRLV8Z29X19M003669	L	grey-silver	gloss
KRLV8Z29X20M003670	XL	grey-silver	gloss

GEAR RATIO 1 x 12

WHEEL DIAMETER 29"

COLOUR VARIANTS



FRAME

FRAME	CARBON NO.2
FORK	ROCK SHOX RECON SILVER RL
FORK TRAVEL	100 mm
SIZES	S(16"), M(17"), L(19"), XL(20")

DRIVETRAIN

REAR DERAILLEUR	SHIMANO DEORE M6100
FRONT BRAKE	SHIMANO MT200
REAR BRAKE	SHIMANO MT200
BRAKE LEVERS	SHIMANO MT200
BRAKE DISCS	SHIMANO RT10 160 CL
SHIFTERS	SHIMANO DEORE M6100
CRANKSET	SHIMANO MT510-1
SPROCKETS	34T
BOTTOM BRACKET	SHIMANO BSA BB52
CHAIN	SHIMANO M6100
CASSETTE/FREEWHEEL	SHIMANO SLX M7100
CASSETTE/FREEWHEEL RANGE	10-51T

WHEELS

FRONT HUB	MT400-B
REAR HUB	MT410-B MICRO SPLINE
RIMS	KROSS ALUMINIUM 622 x 19
TIRES	SCHWALBE RAPID ROB 29 x 2,25

COMPONENTS

HANDLEBAR	ALUMINIUM 720 mm 31.8
HANDLEBAR STEM	ALUMINIUM 60 mm/31,8/12°
SEAT POST	ALUMINIUM 27,2 x 350 mm
HEADSET	FSA ORBIT C-40-ACB NO.42
SADDLE	SELLE ROYAL ERGO MAN
GRIPS	KROSS SCALE

GEOMETRY

SIZE	S	M	L	XL
FS - FRAME SIZE*	16	17	19	20
ST - SEAT TUBE LENGTH**	403	440	470	520
TT - TOP TUBE LENGTH**	570	590	615	630
HT - HEAD TUBE LENGTH**	95	100	110	120
SA - SEAT TUBE ANGLE***	74	74	74	74
HA - HEAD TUBE ANGLE***	69	69	69	69
CS - CHAINSTAY LENGTH**	434	434	434	434
WB - WHEELBASE**	1086	1106	1132	1148
REACH**	397	416	438	451
STACK**	602	606	616	625
BB DROP**	57	57	57	57

* dimension in inches, ** dimension in mm, *** dimension in degrees

LEVEL 8.0



SKU	SIZE	COLOUR	FINISH
KRLV8Z29X16M005608	S	grey-silver	gloss
KRLV8Z29X17M005609	M	grey-silver	gloss
KRLV8Z29X19M005610	L	grey-silver	gloss
KRLV8Z29X20M005611	XL	grey-silver	gloss

GEAR RATIO 1 x 12

WHEEL DIAMETER 29"

COLOUR VARIANTS



FRAME

FRAME	CARBON NO.2
FORK	ROCK SHOX RECON SILVER RL
FORK TRAVEL	100 mm
SIZES	S(16"), M(17"), L(19"), XL(20")

DRIVETRAIN

REAR DERAILLEUR	SHIMANO DEORE M6100
FRONT BRAKE	SHIMANO MT200
REAR BRAKE	SHIMANO MT200
BRAKE LEVERS	SHIMANO MT200
BRAKE DISCS	SHIMANO RT10 160 CL
SHIFTERS	SHIMANO DEORE M6100
CRANKSET	PROWHEEL MPX-CRO94S-TT-B
SPROCKETS	34T/170 mm
BOTTOM BRACKET	SHIMANO BSA BB52
CHAIN	SHIMANO M6100
CASSETTE/FREEWHEEL	SENSAH MTB-CR-HR12
CASSETTE/FREEWHEEL RANGE	10-50T

WHEELS

FRONT HUB	GL-B93F-B/CL-X15 32H
REAR HUB	GL-B93R-SB/CL-X12 MS 32H
RIMS	KROSS ALUMINIUM 622 x 19
TIRES	SCHWALBE RAPID ROB 29 x 2,25

COMPONENTS

HANDLEBAR	ALUMINIUM 720 mm 31.8
HANDLEBAR STEM	ALUMINIUM 60 mm/31,8/12°
SEAT POST	ALUMINIUM 27,2 x 350 mm
HEADSET	FSA ORBIT C-40-ACB NO.42
SADDLE	SELLE ROYAL ERGO MAN
GRIPS	KROSS SCALE

GEOMETRY

SIZE	S	M	L	XL
FS - FRAME SIZE*	16	17	19	20
ST - SEAT TUBE LENGTH**	403	440	470	520
TT - TOP TUBE LENGTH**	570	590	615	630
HT - HEAD TUBE LENGTH**	95	100	110	120
SA - SEAT TUBE ANGLE***	74	74	74	74
HA - HEAD TUBE ANGLE***	69	69	69	69
CS - CHAINSTAY LENGTH**	434	434	434	434
WB - WHEELBASE**	1086	1106	1132	1148
REACH**	397	416	438	451
STACK**	602	606	616	625
BB DROP**	57	57	57	57

* dimension in inches, ** dimension in mm, *** dimension in degrees

LEVEL 7.0

NEW



SKU	SIZE	COLOUR	FINISH
KRLV7Z29X16M007197	S	burgundy-orange	gloss
KRLV7Z29X17M007199	M	burgundy-orange	gloss
KRLV7Z29X19M007201	L	burgundy-orange	gloss
KRLV7Z29X20M007203	XL	burgundy-orange	gloss
KRLV7Z29X16M007198	S	black-gray	gloss
KRLV7Z29X17M007200	M	black-gray	gloss
KRLV7Z29X19M007202	L	black-gray	gloss
KRLV7Z29X20M007204	XL	black-gray	gloss

GEAR RATIO 1 x 11

WHEEL DIAMETER 29"

COLOUR VARIANTS



FRAME

FRAME	CARBON
FORK	ROCK SHOX RECON SILVER RL
FORK TRAVEL	100 mm
SIZES	S(16"), M(17"), L(19"), XL(20")

DRIVETRAIN

REAR DERAILLEUR	SIMANO CUES RD U6000
FRONT BRAKE	SHIMANO MT200
REAR BRAKE	SHIMANO MT200
BRAKE LEVERS	SHIMANO MT200
BRAKE DISCS	SHIMANO RT10 160 CL
SHIFTERS	SHIMANO CUES U6000
CRANKSET	SHIMANO FC-U6000 CUES
SPROCKETS	32T/170 mm
BOTTOM BRACKET	SHIMANO BSA BB52
CHAIN	SHIMANO HG601
CASSETTE/FREEWHEEL	SHIMANO CUES LG400
CASSETTE/FREEWHEEL RANGE	11-50T

WHEELS

FRONT HUB	SHIMANO MT400
REAR HUB	SHIMANO MT400
RIMS	KROSS ALUMINIUM 622 x 25
TIRES	SCHWALBE RAPID ROB 29 x 2,25

COMPONENTS

HANDLEBAR	ALUMINIUM 720 mm 31.8
HANDLEBAR STEM	ALUMINIUM 60 mm/31,8/12°
SEAT POST	ALUMINIUM 27,2 x 350 mm
HEADSET	FP-H856B2 1-1/8"-1.5"
SADDLE	SELLE ROYAL ERGO MAN
GRIPS	PROPALM SILKY

GEOMETRY

SIZE	S	M	L	XL
FS - FRAME SIZE*	16	17	19	20
ST - SEAT TUBE LENGTH**	403	440	470	520
TT - TOP TUBE LENGTH**	570	590	615	630
HT - HEAD TUBE LENGTH**	95	100	110	120
SA - SEAT TUBE ANGLE***	74	74	74	74
HA - HEAD TUBE ANGLE***	69	69	69	69
CS - CHAINSTAY LENGTH**	434	434	434	434
WB - WHEELBASE**	1086	1106	1132	1148
REACH**	397	416	438	451
STACK**	602	606	616	625
BB DROP**	57	57	57	57

* dimension in inches, ** dimension in mm, *** dimension in degrees

LEVEL 7.0



SKU	SIZE	COLOUR	FINISH
KRLV7Z29X16M003662	S	blue-red	gloss
KRLV7Z29X17M003663	M	blue-red	gloss
KRLV7Z29X19M003664	L	blue-red	gloss

GEAR RATIO 1 x 11

WHEEL DIAMETER 29"

COLOUR VARIANTS



FRAME

FRAME	CARBON NO.2
FORK	ROCK SHOX REBA RL
FORK TRAVEL	100 mm
SIZES	S(16"), M(17"), L(19")

DRIVETRAIN

REAR DERAILLEUR	SHIMANO DEORE M5100
FRONT BRAKE	SHIMANO MT200
REAR BRAKE	SHIMANO MT200
BRAKE LEVERS	SHIMANO MT200
BRAKE DISCS	SHIMANO RT10 160 CL
SHIFTERS	SHIMANO DEORE M5100
CRANKSET	SHIMANO DEORE M5100
SPROCKETS	32T
BOTTOM BRACKET	SHIMANO BSA BB52
CHAIN	SHIMANO HG601
CASSETTE/FREEWHEEL	SHIMANO DEORE M5100
CASSETTE/FREEWHEEL RANGE	11-51T

WHEELS

FRONT HUB	SHIMANO MT400-B
REAR HUB	SHIMANO MT400-B
RIMS	KROSS ALUMINIUM 622 x 19
TIRES	SCHWALBE RAPID ROB 29 x 2,25

COMPONENTS

HANDLEBAR	ALUMINIUM 720 mm 31.8
HANDLEBAR STEM	ALUMINIUM 60 mm/31,8/12°
SEAT POST	ALUMINIUM 27,2 x 350 mm
HEADSET	FSA ORBIT C-40-ACB NO.42
SADDLE	SELLE ROYAL ERGO MAN
GRIPS	KROSS SCALE

GEOMETRY

SIZE	S	M	L
FS - FRAME SIZE*	16	17	19
ST - SEAT TUBE LENGTH**	403	440	470
TT - TOP TUBE LENGTH**	570	590	615
HT - HEAD TUBE LENGTH**	95	100	110
SA - SEAT TUBE ANGLE***	74	74	74
HA - HEAD TUBE ANGLE***	69	69	69
CS - CHAINSTAY LENGTH**	434	434	434
WB - WHEELBASE**	1086	1106	1132
REACH**	397	416	438
STACK**	602	606	616
BB DROP**	57	57	57

* dimension in inches, ** dimension in mm, *** dimension in degrees

LEVEL 7.0



SKU	SIZE	COLOUR	FINISH
KRLV7Z29X17M005565	M	blue-red	gloss
KRLV7Z29X19M005566	L	blue-red	gloss
KRLV7Z29X20M005567	XL	blue-red	gloss

GEAR RATIO 1 x 11

WHEEL DIAMETER 29"

COLOUR VARIANTS



FRAME

FRAME	CARBON NO.2
FORK	ROCK SHOX REBA RL
FORK TRAVEL	100 mm
SIZES	M(17"), L(19"), XL(20")

DRIVETRAIN

REAR DERAILLEUR	SHIMANO DEORE M5100
FRONT BRAKE	SHIMANO MT200
REAR BRAKE	SHIMANO MT200
BRAKE LEVERS	SHIMANO MT200
BRAKE DISCS	SHIMANO RT10 160 CL
SHIFTERS	SHIMANO DEORE M5100
CRANKSET	GAMMA PRO 1X MEGAEXO
SPROCKETS	34T/170 mm
BOTTOM BRACKET	MEGAEXO BB Ø24 BB7100
CHAIN	SHIMANO HG601
CASSETTE/FREEWHEEL	SHIMANO DEORE M5100
CASSETTE/FREEWHEEL RANGE	11-51T

WHEELS

FRONT HUB	GL-B74F-B/CL-X15 32H
REAR HUB	GL-B74R-SB/CL-X12 32H
RIMS	KROSS ALUMINIUM 622 x 19
TIRES	SCHWALBE RAPID ROB 29 x 2,25

COMPONENTS

HANDLEBAR	ALUMINIUM 720 mm 31.8
HANDLEBAR STEM	ALUMINIUM 70 mm/31,8/12°
SEAT POST	ALUMINIUM 27,2 x 350 mm
HEADSET	FSA ORBIT C-40-ACB NO.42
SADDLE	SELLE ROYAL ERGO MAN
GRIPS	KROSS SCALE

GEOMETRY

SIZE	M	L	XL
FS - FRAME SIZE*	17	19	20
ST - SEAT TUBE LENGTH**	440	470	520
TT - TOP TUBE LENGTH**	590	615	630
HT - HEAD TUBE LENGTH**	100	110	120
SA - SEAT TUBE ANGLE***	74	74	74
HA - HEAD TUBE ANGLE***	69	69	69
CS - CHAINSTAY LENGTH**	434	434	434
WB - WHEELBASE**	1106	1132	1148
REACH**	416	438	451
STACK**	606	616	625
BB DROP**	57	57	57

* dimension in inches, ** dimension in mm, *** dimension in degrees



LEVEL 6.0, LEVEL 5.0

NEW FRAME

When designing the new versions of Level 6.0, Level 6.0 FEMILINE and Level 5.0, we started from a completely blank slate.

The fresh frame geometry redefines this category and sets the direction for development in the years to come. Beyond high performance and off-road capabilities, what will also matter is the joy of riding and simply having fun when you're not competing.

The new face of these models includes a head tube designed for tapered steerer tubes and internal cable routing, 120 mm air forks, thru-axles, compatibility with dropper seatposts and space for tires up to 2.5" wide. These solutions ensure compliance with the latest standards and maximum enjoyment of XC riding, not only during marathons but also on any single tracks you can dream of.



LEVEL 6.0, LEVEL 5.0

NEW FRAME



LEVEL 6.0

NEW



SKU	SIZE	COLOUR	FINISH
KRLV6Z29X16M007187	S	brown	mat
KRLV6Z29X17M007189	M	brown	mat
KRLV6Z29X18M007191	L	brown	mat
KRLV6Z29X19M007193	XL	brown	mat
KRLV6Z29X20M007195	XXL	brown	mat
KRLV6Z29X16M007188	S	black	gloss
KRLV6Z29X17M007190	M	black	gloss
KRLV6Z29X18M007192	L	black	gloss
KRLV6Z29X19M007194	XL	black	gloss
KRLV6Z29X20M007196	XXL	black	gloss

GEAR RATIO 1 x 12

WHEEL DIAMETER 29"

COLOUR VARIANTS



FRAME

FRAME	ALUMINIUM LITE
FORK	SR SUNTOUR RAIDON32 RLR
FORK TRAVEL	120mm
SIZES	S(16"), M(17"), L(19"), XL(20"), XXL(22")

DRIVETRAIN

REAR DERAILLEUR	SRAM NX EAGLE
FRONT BRAKE	SHIMANO MT420
REAR BRAKE	SHIMANO MT410
BRAKE LEVERS	SHIMANO M4100
BRAKE DISCS	SHIMANO RT64 180 CL
SHIFTERS	SRAM NX EAGLE TRIGGER
CRANKSET	SRAM SX EAGLE
SPROCKETS	34T/170 mm
BOTTOM BRACKET	SRAM BSA DUB
CHAIN	SRAM NX EAGLE
CASSETTE/FREEWHEEL	SRAM PG1230 EAGLE
CASSETTE/FREEWHEEL RANGE	11-50T

WHEELS

FRONT HUB	SHIMANO TC500
REAR HUB	SHIMANO TC500
RIMS	WTB ST I30 TCS 2.0
TIRES	WTB RANGER 29 x 2,4

COMPONENTS

HANDLEBAR	ALUMINIUM 760 mm 35
HANDLEBAR STEM	ALUMINIUM 45 mm/35/0°
SEAT POST	X-FUSION MANIC LC 125mm (S, L); 150mm (L, XL)
HEADSET	FSA 1-1/8"/1.5"
SADDLE	SELLE ROYAL RUN COMFORT GROOVE
GRIPS	VELO VL-884AD2-L1
PEDALS	FP-917N

GEOMETRY

SIZE	S	M	L	XL	XXL
FS - FRAME SIZE*	16	17	19	20	22
ST - SEAT TUBE LENGTH**	400	430	460	490	520
TT - TOP TUBE LENGTH**	595	614	635	655	675
HT - HEAD TUBE LENGTH**	90	100	110	120	130
SA - SEAT TUBE ANGLE***	74	74	74	74	74
HA - HEAD TUBE ANGLE***	67	67	67	67	67
CS - CHAINSTAY LENGTH**	430	430	430	430	430
WB - WHEELBASE**	1138	1160	1181	1203	1224
REACH**	430	448	466	483	500
STACK**	615	624	633	643	652
BB DROP**	58	58	58	58	58

* dimension in inches, ** dimension in mm, *** dimension in degrees

LEVEL 6.0

NEW



SKU	SIZE	COLOUR	FINISH
KRLV6Z29X16W007066	DS	red-black	gloss
KRLV6Z29X17W007068	DM	red-black	gloss
KRLV6Z29X18W007070	DL	red-black	gloss
KRLV6Z29X16W007067	DS	beige	gloss
KRLV6Z29X17W007069	DM	beige	gloss
KRLV6Z29X18W007071	DL	beige	gloss

GEAR RATIO 1 x 12

WHEEL DIAMETER 29"

COLOUR VARIANTS



FRAME

FRAME	ALUMINIUM 6061
FORK	SR SUNTOUR RAIDON32 RLR
FORK TRAVEL	120mm
SIZES	DS(16"), DM(17"), DL(29")

DRIVETRAIN

REAR DERAILLEUR	SRAM NX EAGLE
FRONT BRAKE	SHIMANO MT420
REAR BRAKE	SHIMANO MT410
BRAKE LEVERS	SHIMANO M4100
BRAKE DISCS	SHIMANO RT64 180 CL
SHIFTERS	SRAM NX EAGLE TRIGGER
CRANKSET	SRAM SX EAGLE
SPROCKETS	34T/170 mm
BOTTOM BRACKET	SRAM BSA DUB
CHAIN	SRAM NX EAGLE
CASSETTE/FREEWHEEL	SRAM PG1230 EAGLE
CASSETTE/FREEWHEEL RANGE	11-50T

WHEELS

FRONT HUB	SHIMANO TC500
REAR HUB	SHIMANO TC500
RIMS	WTB ST I30 TCS 2.0
TIRES	WTB RANGER 29 x 2,4

COMPONENTS

HANDLEBAR	ALUMINIUM 760 mm 35
HANDLEBAR STEM	ALUMINIUM 45 mm/35/0°
SEAT POST	X-FUSION MANIC LC 125mm (S, L); 150mm (L, XL)
HEADSET	FSA 1-1/8"/1.5"
SADDLE	SELLE ROYAL RUN COMFORT GROOVE
GRIPS	VELO VL-884AD2-L1
PEDALS	FP-917N

GEOMETRY

SIZE	DS	DM	DL
FS - FRAME SIZE*	16	17	18
ST - SEAT TUBE LENGTH**	400	430	460
TT - TOP TUBE LENGTH**	595	614	635
HT - HEAD TUBE LENGTH**	90	100	110
SA - SEAT TUBE ANGLE***	74	74	74
HA - HEAD TUBE ANGLE***	67	67	67
CS - CHAINSTAY LENGTH**	430	430	430
WB - WHEELBASE**	1138	1160	1181
REACH**	430	448	466
STACK**	615	624	633
BB DROP**	58	58	58

* dimension in inches, ** dimension in mm, *** dimension in degrees

LEVEL 6.0



SKU	SIZE	COLOUR	FINISH
KRLV6Z29X17M005367	M	ruby red-silver	gloss
KRLV6Z29X19M005368	L	ruby red-silver	gloss
KRLV6Z29X20M005369	XL	ruby red-silver	gloss
KRLV6Z29X22M005370	XXL	ruby red-silver	gloss

GEAR RATIO 1 x 12

WHEEL DIAMETER 29"

COLOUR VARIANTS



FRAME

FRAME	ALUMINIUM LITE
FORK	SR SUNTOUR RAIDON-XC RLR
FORK TRAVEL	100 mm
SIZES	M(17"), L(19"), XL(20"), XXL(22")

DRIVETRAIN

REAR DERAILLEUR	SHIMANO DEORE M6100
FRONT BRAKE	SRAM LEVEL
REAR BRAKE	SRAM LEVEL
BRAKE LEVERS	SRAM LEVEL
BRAKE DISCS	SHIMANO RT10 160 CL
SHIFTERS	SHIMANO DEORE M6100
CRANKSET	PROWHEEL MPC-CR094S-TT
SPROCKETS	34T/175 mm
BOTTOM BRACKET	PROWHEEL BB68+
CHAIN	SHIMANO M6100
CASSETTE/FREEWHEEL	MTB-CS-HR-1050AHS
CASSETTE/FREEWHEEL RANGE	10-50T

WHEELS

FRONT HUB	MT200
REAR HUB	MT401-B MICRO SPLINE
RIMS	KROSS
TIRES	SCHWALBE RAPID ROB 29 x 2,25

COMPONENTS

HANDLEBAR	ALUMINIUM 720 mm 31,8
HANDLEBAR STEM	ALUMINIUM 70 mm/31,8/17°
SEAT POST	ALUMINIUM 27,2 x 350 mm
HEADSET	FP-H813PL 1-1/8"
SADDLE	SELLE ROYAL ERGO MAN
GRIPS	KROSS SCALE
PEDALS	FP-917N

GEOMETRY

SIZE	M	L	XL	XXL
FS - FRAME SIZE*	17	19	20	22
ST - SEAT TUBE LENGTH**	440	470	520	560
TT - TOP TUBE LENGTH**	592	616	640	664
HT - HEAD TUBE LENGTH**	110	125	140	155
SA - SEAT TUBE ANGLE***	74	74	74	74
HA - HEAD TUBE ANGLE***	69	69	69	69
CS - CHAINSTAY LENGTH**	445	445	445	445
WB - WHEELBASE**	1125	1150	1175	1197
REACH**	415	435	455	475
STACK**	619	633	647	661
BB DROP**	60	60	60	60

* dimension in inches, ** dimension in mm, *** dimension in degrees

LEVEL 5.0

NEW



SKU	SIZE	COLOUR	FINISH
KRLV5Z29X16M007177	S	navy	gloss
KRLV5Z29X17M007179	M	navy	gloss
KRLV5Z29X18M007181	L	navy	gloss
KRLV5Z29X19M007183	XL	navy	gloss
KRLV5Z29X20M007185	XXL	navy	gloss
KRLV5Z29X16M007178	S	green	gloss
KRLV5Z29X17M007180	M	green	gloss
KRLV5Z29X18M007182	L	green	gloss
KRLV5Z29X19M007184	XL	green	gloss
KRLV5Z29X20M007186	XXL	green	gloss

GEAR RATIO 1 x 11

WHEEL DIAMETER 29"

COLOUR VARIANTS



FRAME

FRAME	ALUMINIUM LITE
FORK	SR SUNTOUR XCR 32 COIL RL
FORK TRAVEL	120mm
SIZES	S(16"), M(17"), L(19"), XL(20"), XXL(22")

DRIVETRAIN

REAR DERAILLEUR	SIMANO CUES RD U6000
FRONT BRAKE	SHIMANO MT200
REAR BRAKE	SHIMANO MT200
BRAKE LEVERS	SHIMANO MT200
BRAKE DISCS	SHIMANO RT10 180 CL
SHIFTERS	SHIMANO CUES U6000
CRANKSET	SHIMANO FC-U6000 CUES
SPROCKETS	32T/170 mm
BOTTOM BRACKET	SHIMANO BB-MT501
CHAIN	SHIMANO LG500
CASSETTE/FREEWHEEL	SHIMANO CUES LG400
CASSETTE/FREEWHEEL RANGE	11-50T

WHEELS

FRONT HUB	SHIMANO TC500
REAR HUB	SHIMANO TC500
RIMS	KROSS ALUMINIUM 622 x 25
TIRES	SCHWALBE SMART SAM 29 x 2,35

COMPONENTS

HANDLEBAR	ALUMINIUM 760 mm 35
HANDLEBAR STEM	ALUMINIUM 45 mm/35/0°
SEAT POST	ALUMINIUM 31,6
HEADSET	FSA 1-1/8"/1.5"
SADDLE	SELLE ROYAL RUN COMFORT GROOVE
GRIPS	VELO VL-884AD2-L1
PEDALS	FP-917N

GEOMETRY

SIZE	S	M	L	XL	XXL
FS - FRAME SIZE*	16	17	18	19	20
ST - SEAT TUBE LENGTH**	400	430	460	490	520
TT - TOP TUBE LENGTH**	595	614	635	655	675
HT - HEAD TUBE LENGTH**	90	100	110	120	130
SA - SEAT TUBE ANGLE***	74	74	74	74	74
HA - HEAD TUBE ANGLE***	67	67	67	67	67
CS - CHAINSTAY LENGTH**	430	430	430	430	430
WB - WHEELBASE**	1138	1160	1181	1203	1224
REACH**	430	448	466	483	500
STACK**	615	624	633	643	652
BB DROP**	58	58	58	58	58

* dimension in inches, ** dimension in mm, *** dimension in degrees

LEVEL 5.0



SKU	SIZE	COLOUR	FINISH
KRLV5Z29X17M002355	S	black-silver	gloss
KRLV5Z29X19M002356	M	black-silver	gloss
KRLV5Z29X19M002362	L	blue-silver	gloss
KRLV5Z29X20M002363	XL	blue-silver	gloss
KRLV5Z29X22M002364	XXL	blue-silver	gloss

GEAR RATIO 1 x 11

WHEEL DIAMETER 29"

COLOUR VARIANTS



FRAME

FRAME	ALUMINIUM LITE
FORK	SR SUNTOUR XCR AIR RLR
FORK TRAVEL	100 mm
SIZES	S(16"), M(17"), L(19"), XL(20"), XXL(22")

DRIVETRAIN

REAR DERAILLEUR	SHIMANO DEORE M5100
FRONT BRAKE	SRAM LEVEL
REAR BRAKE	SRAM LEVEL
BRAKE LEVERS	SRAM LEVEL
BRAKE DISCS	SHIMANO RT10 160 CL
SHIFTERS	SHIMANO DEORE M5100
CRANKSET	SHIMANO DEORE M5100
SPROCKETS	32T
BOTTOM BRACKET	SHIMANO BSA BB52
CHAIN	SHIMANO HG601
CASSETTE/FREEWHEEL	SHIMANO DEORE M5100
CASSETTE/FREEWHEEL RANGE	11-51T

WHEELS

FRONT HUB	MT200
REAR HUB	MT200-B
RIMS	KROSS ALUMINIUM 622 x 19
TIRES	SCHWALBE RAPID ROB 29 x 2,25

COMPONENTS

HANDLEBAR	ALUMINIUM 720 mm 31.8
HANDLEBAR STEM	ALUMINIUM 70 mm/31,8/17°
SEAT POST	ALUMINIUM 27,2 x 350 mm
HEADSET	FP-H813PL 1-1/8"
SADDLE	SELLE ROYAL ERGO MAN
GRIPS	KROSS SCALE
PEDALS	FP-917N

GEOMETRY

SIZE	S	M	L	XL	XXL
FS - FRAME SIZE*	16	17	19	20	22
ST - SEAT TUBE LENGTH**	400	440	470	520	560
TT - TOP TUBE LENGTH**	568	592	616	640	664
HT - HEAD TUBE LENGTH**	100	110	125	140	155
SA - SEAT TUBE ANGLE***	74	74	74	74	74
HA - HEAD TUBE ANGLE***	69	69	69	69	69
CS - CHAINSTAY LENGTH**	445	445	445	445	445
WB - WHEELBASE**	1085	1125	1150	1175	1197
REACH**	393	415	435	455	475
STACK**	609	619	633	647	661
BB DROP**	60	60	60	60	60

* dimension in inches, ** dimension in mm, *** dimension in degrees

LEVEL 5.0



SKU	SIZE	COLOUR	FINISH
KRLV5Z29X17M005358	M	black-silver	gloss
KRLV5Z29X19M005359	L	black-silver	gloss
KRLV5Z29X20M005360	XL	black-silver	gloss
KRLV5Z29X17M005362	M	blue-silver	gloss
KRLV5Z29X19M005363	L	blue-silver	gloss
KRLV5Z29X20M005364	XL	blue-silver	gloss
KRLV5Z29X22M005365	XXL	blue-silver	gloss

GEAR RATIO 1 x 11

WHEEL DIAMETER 29"

COLOUR VARIANTS



FRAME

FRAME	ALUMINIUM LITE
FORK	SR SUNTOUR XCR 32 RLR AIR
FORK TRAVEL	100 mm
SIZES	S(16"), M(17"), L(19"), XL(20"), XXL(22")

DRIVETRAIN

REAR DERAILLEUR	SHIMANO DEORE M5100
FRONT BRAKE	SRAM LEVEL
REAR BRAKE	SRAM LEVEL
BRAKE LEVERS	SRAM LEVEL
BRAKE DISCS	SHIMANO RT10 160 CL
SHIFTERS	SHIMANO DEORE M5100
CRANKSET	GAMMA PRO 1X MEGAEXO
SPROCKETS	34T
BOTTOM BRACKET	FSA MEGAEXO MT7100
CHAIN	SHIMANO HG6001
CASSETTE/FREEWHEEL	SHIMANO DEORE M5100
CASSETTE/FREEWHEEL RANGE	11-51T

WHEELS

FRONT HUB	MT200
REAR HUB	MT200-B
RIMS	KROSS
TIRES	SCHWALBE RAPID ROB 29 x 2,25

COMPONENTS

HANDLEBAR	ALUMINIUM 720 mm 31.8
HANDLEBAR STEM	ALUMINIUM 70 mm/31,8/17°
SEAT POST	ALUMINIUM 27,2 x 350 mm
HEADSET	FP-H813PL 1-1/8"
SADDLE	SELLE ROYAL ERGO MAN
GRIPS	KROSS SCALE
PEDALS	FP-917N

GEOMETRY

SIZE	S	M	L	XL	XXL
FS - FRAME SIZE*	16	17	19	20	22
ST - SEAT TUBE LENGTH**	400	440	470	520	560
TT - TOP TUBE LENGTH**	568	592	616	640	664
HT - HEAD TUBE LENGTH**	100	110	125	140	155
SA - SEAT TUBE ANGLE***	74	74	74	74	74
HA - HEAD TUBE ANGLE***	69	69	69	69	69
CS - CHAINSTAY LENGTH**	445	445	445	445	445
WB - WHEELBASE**	1085	1125	1150	1175	1197
REACH**	393	415	435	455	475
STACK**	609	619	633	647	661
BB DROP**	60	60	60	60	60

* dimension in inches, ** dimension in mm, *** dimension in degrees

LEVEL 4.0

NEW



SKU	SIZE	COLOUR	FINISH
KRLV4Z29X16M007054	S	khaki	mat
KRLV4Z29X17M007056	M	khaki	mat
KRLV4Z29X19M007058	L	khaki	mat
KRLV4Z29X20M007060	XL	khaki	mat
KRLV4Z29X22M007062	XXL	khaki	mat
KRLV4Z29X16M007055	S	yellow	gloss
KRLV4Z29X17M007057	M	yellow	gloss
KRLV4Z29X19M007059	L	yellow	gloss
KRLV4Z29X20M007061	XL	yellow	gloss
KRLV4Z29X22M007063	XXL	yellow	gloss

GEAR RATIO 1 x 10

WHEEL DIAMETER 29"

COLOUR VARIANTS



FRAME

FRAME	ALUMINIUM 6061
FORK	SR SUNTOUR XCR 32 COIL RL
FORK TRAVEL	100 mm
SIZES	S(16"), M(17"), L(19"), XL(20"), XXL(22")

DRIVETRAIN

REAR DERAILLEUR	SIMANO CUES RD U6000
FRONT BRAKE	SHIMANO MT200
REAR BRAKE	SHIMANO MT200
BRAKE LEVERS	SHIMANO MT200
BRAKE DISCS	SHIMANO RT10 180 CL
SHIFTERS	SHIMANO CUSE U6000
CRANKSET	SHIMANO FC-U6000 CUES
SPROCKETS	32T/170 mm
BOTTOM BRACKET	SHIMANO BB-MT501
CHAIN	SHIMANO LG500
CASSETTE/FREEWHEEL	SHIMANO CUES LG300
CASSETTE/FREEWHEEL RANGE	11-48T

WHEELS

FRONT HUB	SHIMANO MT200
REAR HUB	SHIMANO ALTUS MT200
RIMS	KROSS ALUMINIUM 622 x 25
TIRES	SCHWALBE SMART SAM 29 x 2,25

COMPONENTS

HANDLEBAR	ALUMINIUM 720 mm 31.8
HANDLEBAR STEM	ALUMINIUM 70 mm/31,8/17°
SEAT POST	ALUMINIUM 27,2 x 350 mm
HEADSET	FP-H816 O1-1/8"
SADDLE	SELLE ROYAL VIVO PU
GRIPS	PROPALM SCALE
PEDALS	FP-917N

GEOMETRY

SIZE	S	M	L	XL	XXL
FS - FRAME SIZE*	16	17	19	20	22
ST - SEAT TUBE LENGTH**	400	440	470	520	560
TT - TOP TUBE LENGTH**	568	592	616	640	664
HT - HEAD TUBE LENGTH**	100	110	125	140	155
SA - SEAT TUBE ANGLE***	74	74	74	74	74
HA - HEAD TUBE ANGLE***	69	69	69	69	69
CS - CHAINSTAY LENGTH**	445	445	445	445	445
WB - WHEELBASE**	1085	1125	1150	1175	1197
REACH**	393	415	435	455	475
STACK**	609	619	633	647	661
BB DROP**	60	60	60	60	60

* dimension in inches, ** dimension in mm, *** dimension in degrees

LEVEL 4.0

NEW



SKU	SIZE	COLOUR	FINISH
KRLV4Z29X15W007046	DXS	purple	gloss
KRLV4Z29X16W007048	DS	purple	gloss
KRLV4Z29X17W007050	DM	purple	gloss
KRLV4Z29X19W007052	DL	purple	gloss
KRLV4Z29X15W007047	DXS	bordowy	mat
KRLV4Z29X16W007049	DS	bordowy	mat
KRLV4Z29X17W007051	DM	bordowy	mat
KRLV4Z29X19W007053	DL	bordowy	mat

GEAR RATIO 1 x 10

WHEEL DIAMETER 29"

COLOUR VARIANTS



FRAME

FRAME	ALUMINIUM 6061
FORK	SR SUNTOUR XCR 32 COIL RL
FORK TRAVEL	100 mm
SIZES	DXS(14"), DS(16"), DM(17"), DL(18")

DRIVETRAIN

REAR DERAILLEUR	SIMANO CUES RD U6000
FRONT BRAKE	SHIMANO MT200
REAR BRAKE	SHIMANO MT200
BRAKE LEVERS	SHIMANO MT200
BRAKE DISCS	SHIMANO RT10 180 CL
SHIFTERS	SHIMANO CUSE U6000
CRANKSET	SHIMANO FC-U6000 CUES
SPROCKETS	32T/170 mm
BOTTOM BRACKET	SHIMANO BB-MT501
CHAIN	SHIMANO LG500
CASSETTE/FREEWHEEL	SHIMANO CUES LG300
CASSETTE/FREEWHEEL RANGE	11-48T

WHEELS

FRONT HUB	SHIMANO MT200
REAR HUB	SHIMANO ALTUS MT200
RIMS	KROSS ALUMINIUM 622 x 25
TIRES	SCHWALBE SMART SAM 29 x 2,25

COMPONENTS

HANDLEBAR	ALUMINIUM 720 mm 31.8
HANDLEBAR STEM	ALUMINIUM 70 mm/31,8/17°
SEAT POST	ALUMINIUM 27,2 x 350 mm
HEADSET	FP-H816 O1-1/8"
SADDLE	SELLE ROYAL VIVO WOMAN
GRIPS	PROPALM SCALE
PEDALS	FP-917N

GEOMETRY

SIZE	DXS	DS	DM	DL
FS - FRAME SIZE*	14	16	17	18
ST - SEAT TUBE LENGTH**	355	400	430	460
TT - TOP TUBE LENGTH**	524	595	614	635
HT - HEAD TUBE LENGTH**	100	90	100	110
SA - SEAT TUBE ANGLE***	74	74	74	74
HA - HEAD TUBE ANGLE***	68	67	67	67
CS - CHAINSTAY LENGTH**	435	430	430	430
WB - WHEELBASE**	355	1138	1160	1181
REACH**	591	430	448	466
STACK**	1051	615	624	633
BB DROP**	50	58	58	58

* dimension in inches, ** dimension in mm, *** dimension in degrees

LEVEL 3.0



SKU	SIZE	COLOUR	FINISH
KRLV3Z29X16M004903	S	red-white	gloss
KRLV3Z29X17M004904	M	red-white	gloss
KRLV3Z29X19M006445	L	red-white	gloss
KRLV3Z29X16M004908	S	grey-black	gloss
KRLV3Z29X19M006447	L	grey-black	gloss
KRLV3Z29X20M004911	XL	grey-black	gloss

GEAR RATIO 2 x 9

WHEEL DIAMETER 29"

COLOUR VARIANTS



FRAME

FRAME	ALUMINIUM LITE
FORK	SR SUNTOUR XCM RL
FORK TRAVEL	100 mm
SIZES	S(16"), M(17"), L(19"), XL(20"), XXL(22")

DRIVETRAIN

FRONT DERAILLEUR	SHIMANO ALTUS M2020
REAR DERAILLEUR	SHIMANO DEORE M592
FRONT BRAKE	SRAM LEVEL
REAR BRAKE	SRAM LEVEL
BRAKE LEVERS	SRAM LEVEL
BRAKE DISCS	SHIMANO RT10 160 CL
SHIFTERS	SHIMANO SL-M3100
CRANKSET	PROWHEEL RAID-501
SPROCKETS	36-22T/175 mm
BOTTOM BRACKET	FP-B902
CHAIN	SHIMANO HG53
CASSETTE/FREEWHEEL	SUNRACE CSM90
CASSETTE/FREEWHEEL RANGE	11-34T

WHEELS

FRONT HUB	MT200
REAR HUB	MT200-B
RIMS	KROSS ALUMINIUM 622 x 19
TIRES	SCHWALBE SMART SAM 29 x 2,25

COMPONENTS

HANDLEBAR	ALUMINIUM 720 mm 31.8
HANDLEBAR STEM	ALUMINIUM 70 mm/31,8/17°
SEAT POST	ALUMINIUM 27,2 x 350 mm
HEADSET	FP-H816 O1-1/8"
SADDLE	SELLE ROYAL VIVO PU
GRIPS	KROSS SCALE
PEDALS	FP-917N

GEOMETRY

SIZE	S	M	L	XL	XXL
FS - FRAME SIZE*	16	17	19	20	22
ST - SEAT TUBE LENGTH**	400	440	470	520	560
TT - TOP TUBE LENGTH**	568	592	616	640	664
HT - HEAD TUBE LENGTH**	100	110	125	140	155
SA - SEAT TUBE ANGLE***	74	74	74	74	74
HA - HEAD TUBE ANGLE***	69	69	69	69	69
CS - CHAINSTAY LENGTH**	445	445	445	445	445
WB - WHEELBASE**	1085	1125	1150	1175	1197
REACH**	393	415	435	455	475
STACK**	609	619	633	647	661
BB DROP**	60	60	60	60	60

* dimension in inches, ** dimension in mm, *** dimension in degrees

LEVEL 3.0



SKU	SIZE	COLOUR	FINISH
KRLV3Z29X17M006448	M	red-white	gloss
KRLV3Z29X19M006444	L	red-white	gloss
KRLV3Z29X17M006449	M	grey-black	gloss
KRLV3Z29X19M006446	L	grey-black	gloss

GEAR RATIO 2 x 9

WHEEL DIAMETER 29"

COLOUR VARIANTS



FRAME

FRAME	ALUMINIUM LITE
FORK	SR SUNTOUR XCM RL
FORK TRAVEL	100 mm
SIZES	M(17"), L(19")

DRIVETRAIN

FRONT DERAILLEUR	SHIMANO ALTUS M2020
REAR DERAILLEUR	SHIMANO DEORE M592
FRONT BRAKE	SRAM LEVEL
REAR BRAKE	SRAM LEVEL
BRAKE LEVERS	SRAM LEVEL
BRAKE DISCS	SHIMANO RT10 160 CL
SHIFTERS	SHIMANO SL-M3100
CRANKSET	SHIMANO MT101
SPROCKETS	36-22T/175 mm
BOTTOM BRACKET	FP-B902
CHAIN	SHIMANO HG53
CASSETTE/FREEWHEEL	SHIMANO ALTUS HG201
CASSETTE/FREEWHEEL RANGE	11-36T

WHEELS

FRONT HUB	MT200
REAR HUB	MT200-B
RIMS	KROSS ALUMINIUM 622 x 19
TIRES	SCHWALBE SMART SAM 29 x 2,25

COMPONENTS

HANDLEBAR	ALUMINIUM 720 mm 31.8
HANDLEBAR STEM	ALUMINIUM 70 mm/31,8/17°
SEAT POST	ALUMINIUM 27,2 x 350 mm
HEADSET	FP-H816 01-1/8"
SADDLE	SELLE ROYAL VIVO PU
GRIPS	KROSS SCALE
PEDALS	FP-917N

GEOMETRY

SIZE	M	L
FS - FRAME SIZE*	17	19
ST - SEAT TUBE LENGTH**	440	470
TT - TOP TUBE LENGTH**	592	616
HT - HEAD TUBE LENGTH**	110	125
SA - SEAT TUBE ANGLE***	74	74
HA - HEAD TUBE ANGLE***	69	69
CS - CHAINSTAY LENGTH**	445	445
WB - WHEELBASE**	1125	1150
REACH**	415	435
STACK**	619	633
BB DROP**	60	60

* dimension in inches, ** dimension in mm, *** dimension in degrees

LEVEL 2.0

NEW



SKU	SIZE	COLOUR	FINISH
KRLV2Z29X16M007036	S	blue	gloss
KRLV2Z29X17M007038	M	blue	gloss
KRLV2Z29X19M007040	L	blue	gloss
KRLV2Z29X20M007042	XL	blue	gloss
KRLV2Z29X22M007044	XXL	blue	gloss
KRLV2Z29X16M007037	S	black	gloss
KRLV2Z29X17M007039	M	black	gloss
KRLV2Z29X19M007041	L	black	gloss
KRLV2Z29X20M007043	XL	black	gloss
KRLV2Z29X22M007045	XXL	black	gloss

GEAR RATIO 2 x 9

WHEEL DIAMETER 29"

COLOUR VARIANTS



FRAME

FRAME	ALUMINIUM 6061
FORK	SR SUNTOUR XCM RL
FORK TRAVEL	100 mm
SIZES	S(16"), M(17"), L(19"), XL(20"), XXL(22")

DRIVETRAIN

FRONT DERAILLEUR	SIMANO CUES FD U4000
REAR DERAILLEUR	SIMANO CUES RD U3020
FRONT BRAKE	SHIMANO MT200
REAR BRAKE	SHIMANO MT200
BRAKE LEVERS	SHIMANO MT200
BRAKE DISCS	SHIMANO RT10 180 CL
SHIFTERS	SHIMANO CUES U4000
CRANKSET	SHIMANO FC-U4000 CUES
SPROCKETS	36T-22T/175 mm
BOTTOM BRACKET	FP-B902
CHAIN	SHIMANO LG500
CASSETTE/FREEWHEEL	SHIMANO CUES LG300
CASSETTE/FREEWHEEL RANGE	11-36T

WHEELS

FRONT HUB	SHIMANO MT200
REAR HUB	SHIMANO ALTUS MT200
RIMS	KROSS ALUMINIUM 622 x 25
TIRES	SCHWALBE SMART SAM 29 x 2,25

COMPONENTS

HANDLEBAR	ALUMINIUM 740 mm 31.8
HANDLEBAR STEM	ALUMINIUM 70 mm/31,8/17°
SEAT POST	ALUMINIUM 27,2 x 350 mm
HEADSET	FP-H816 01-1/8"
SADDLE	SELLE ROYAL VIVO PU
GRIPS	PROPALM SCALE
PEDALS	FP-917N

GEOMETRY

SIZE	S	M	L	XL	XXL
FS - FRAME SIZE*	16	17	19	20	22
ST - SEAT TUBE LENGTH**	400	440	470	520	560
TT - TOP TUBE LENGTH**	568	592	616	640	664
HT - HEAD TUBE LENGTH**	100	110	125	140	155
SA - SEAT TUBE ANGLE***	74	74	74	74	74
HA - HEAD TUBE ANGLE***	69	69	69	69	69
CS - CHAINSTAY LENGTH**	445	445	445	445	445
WB - WHEELBASE**	1085	1125	1150	1175	1197
REACH**	393	415	435	455	475
STACK**	609	619	633	647	661
BB DROP**	60	60	60	60	60

* dimension in inches, ** dimension in mm, *** dimension in degrees

LEVEL 2.0



SKU	SIZE	COLOUR	FINISH
KRLV2Z29X17M002325	M	navy blue-red	gloss
KRLV2Z29X19M002326	L	navy blue-red	gloss
KRLV2Z29X17M002319	M	yellow-black	gloss
KRLV2Z29X19M002320	L	yellow-black	gloss
KRLV2Z29X22M002322	XXL	yellow-black	gloss

GEAR RATIO 2 x 9

WHEEL DIAMETER 29"

COLOUR VARIANTS



FRAME

FRAME	ALUMINIUM LITE
FORK	SR SUNTOUR XCM RL
FORK TRAVEL	100 mm
SIZES	M(17"), L(19"), XXL(22")

DRIVETRAIN

FRONT DERAILLEUR	SHIMANO ALTUS M2020
REAR DERAILLEUR	SHIMANO ALIVIO M3100
FRONT BRAKE	JAK-Y2 NUTT
REAR BRAKE	JAK-Y2 NUTT
BRAKE LEVERS	JAK-Y2 NUTT
BRAKE DISCS	SHIMANO RT10 160 CL
SHIFTERS	SHIMANO ALTUS M2010
CRANKSET	SHIMANO MT101
SPROCKETS	36-22T/175 mm
BOTTOM BRACKET	FP-B902
CHAIN	SHIMANO HG53
CASSETTE/FREEWHEEL	SHIMANO ALTUS HG201
CASSETTE/FREEWHEEL RANGE	11-36T

WHEELS

FRONT HUB	MT200
REAR HUB	MT200-B
RIMS	KROSS ALUMINIUM 622 x 19
TIRES	SCHWALBE SMART SAM 29 x 2,25

COMPONENTS

HANDLEBAR	ALUMINIUM 720 mm 31.8
HANDLEBAR STEM	ALUMINIUM 70 mm/31,8/17°
SEAT POST	ALUMINIUM 27,2 x 350 mm
HEADSET	FP-H816 O1-1/8"
SADDLE	SELLE ROYAL VIVO PU
GRIPS	KROSS SCALE
PEDALS	FP-917N

GEOMETRY

SIZE	M	L	XXL
FS - FRAME SIZE*	17	19	22
ST - SEAT TUBE LENGTH**	440	470	560
TT - TOP TUBE LENGTH**	592	616	664
HT - HEAD TUBE LENGTH**	110	125	155
SA - SEAT TUBE ANGLE***	74	74	74
HA - HEAD TUBE ANGLE***	69	69	69
CS - CHAINSTAY LENGTH**	445	445	445
WB - WHEELBASE**	1125	1150	1197
REACH**	415	435	475
STACK**	619	633	661
BB DROP**	60	60	60

* dimension in inches, ** dimension in mm, *** dimension in degrees

LEVEL 2.0



SKU	SIZE	COLOUR	FINISH
KRLV2Z29X16M005373	S	yellow-black	gloss
KRLV2Z29X17M005334	M	yellow-black	gloss
KRLV2Z29X19M005335	L	yellow-black	gloss
KRLV2Z29X20M005336	XL	yellow-black	gloss
KRLV2Z29X22M005337	XXL	yellow-black	gloss
KRLV2Z29X16M005374	S	navy blue-red	gloss
KRLV2Z29X17M005338	M	navy blue-red	gloss
KRLV2Z29X19M005339	L	navy blue-red	gloss
KRLV2Z29X20M005340	XL	navy blue-red	gloss
KRLV2Z29X22M005341	XXL	navy blue-red	gloss

GEAR RATIO 2 x 9

WHEEL DIAMETER 29"

COLOUR VARIANTS



FRAME

FRAME	ALUMINIUM LITE
FORK	SR SUNTOUR XCM RL
FORK TRAVEL	100 mm
SIZES	S(16"), M(17"), L(19"), XL(20"), XXL(22")

DRIVETRAIN

FRONT DERAILLEUR	SHIMANO ALTUS M2020
REAR DERAILLEUR	SHIMANO ALIVIO M3100
FRONT BRAKE	SRAM LEVEL
REAR BRAKE	SRAM LEVEL
BRAKE LEVERS	SRAM LEVEL
BRAKE DISCS	SHIMANO RT10 160 CL
SHIFTERS	MICROSHIFT MARVO SL-M859
CRANKSET	SHIMANO MT101
SPROCKETS	36-22T/175 mm
BOTTOM BRACKET	FP-B902
CHAIN	YBN S9
CASSETTE/FREEWHEEL	SHIMANO ALTUS HG201
CASSETTE/FREEWHEEL RANGE	11-36T

WHEELS

FRONT HUB	MT200
REAR HUB	MT200-B
RIMS	KROSS ALUMINIUM 622 x 19
TIRES	SCHWALBE SMART SAM 29 x 2,25

COMPONENTS

HANDLEBAR	ALUMINIUM 720 mm 31.8
HANDLEBAR STEM	ALUMINIUM 70 mm/31,8/17°
SEAT POST	ALUMINIUM 27,2 x 350 mm
HEADSET	FP-H816 O1-1/8"
SADDLE	SELLE ROYAL VIVO PU
GRIPS	KROSS SCALE
PEDALS	FP-917N

GEOMETRY

SIZE	S	M	L	XL	XXL
FS - FRAME SIZE*	16	17	19	20	22
ST - SEAT TUBE LENGTH**	400	440	470	520	560
TT - TOP TUBE LENGTH**	568	592	616	640	664
HT - HEAD TUBE LENGTH**	100	110	125	140	155
SA - SEAT TUBE ANGLE***	74	74	74	74	74
HA - HEAD TUBE ANGLE***	69	69	69	69	69
CS - CHAINSTAY LENGTH**	445	445	445	445	445
WB - WHEELBASE**	1085	1125	1150	1175	1197
REACH**	393	415	435	455	475
STACK**	609	619	633	647	661
BB DROP**	60	60	60	60	60

* dimension in inches, ** dimension in mm, *** dimension in degrees

LEVEL 2.0



SKU	SIZE	COLOUR	FINISH
KRLV2Z29X17M006434	M	navy blue-red	gloss
KRLV2Z29X19M006431	L	navy blue-red	gloss
KRLV2Z29X20M006438	XL	navy blue-red	gloss
KRLV2Z29X22M006442	XXL	navy blue-red	gloss
KRLV2Z29X17M006436	M	yellow-black	gloss
KRLV2Z29X19M006433	L	yellow-black	gloss
KRLV2Z29X20M006440	XL	yellow-black	gloss
KRLV2Z29X22M006443	XXL	yellow-black	gloss

GEAR RATIO 2 x 9

WHEEL DIAMETER 29"

COLOUR VARIANTS



FRAME

FRAME	ALUMINIUM LITE
FORK	SR SUNTOUR XCM RL
FORK TRAVEL	100 mm
SIZES	M(17"), L(19"), XL(20"), XXL(22")

DRIVETRAIN

FRONT DERAILLEUR	SHIMANO ALTUS M2020
REAR DERAILLEUR	SHIMANO ALIVIO M3100
FRONT BRAKE	SRAM LEVEL
REAR BRAKE	SRAM LEVEL
BRAKE LEVERS	SRAM LEVEL
BRAKE DISCS	SHIMANO RT10 160 CL
SHIFTERS	SHIMANO ALTUS M2010
CRANKSET	SHIMANO MT101
SPROCKETS	36-22T/175 mm
BOTTOM BRACKET	FP-B902
CHAIN	SHIMANO HG53
CASSETTE/FREEWHEEL	SHIMANO ALTUS HG201
CASSETTE/FREEWHEEL RANGE	11-36T

WHEELS

FRONT HUB	MT200
REAR HUB	MT200-B
RIMS	KROSS ALUMINIUM 622 x 19
TIRES	SCHWALBE SMART SAM 29 x 2,25

COMPONENTS

HANDLEBAR	ALUMINIUM 720 mm 31.8
HANDLEBAR STEM	ALUMINIUM 70 mm/31,8/17°
SEAT POST	ALUMINIUM 27,2 x 350 mm
HEADSET	FP-H816 O1-1/8"
SADDLE	SELLE ROYAL VIVO PU
GRIPS	KROSS SCALE
PEDALS	FP-917N

GEOMETRY

SIZE	M	L	XL	XXL
FS - FRAME SIZE*	17	19	20	22
ST - SEAT TUBE LENGTH**	440	470	520	560
TT - TOP TUBE LENGTH**	592	616	640	664
HT - HEAD TUBE LENGTH**	110	125	140	155
SA - SEAT TUBE ANGLE***	74	74	74	74
HA - HEAD TUBE ANGLE***	69	69	69	69
CS - CHAINSTAY LENGTH**	445	445	445	445
WB - WHEELBASE**	1125	1150	1175	1197
REACH**	415	435	455	475
STACK**	619	633	647	661
BB DROP**	60	60	60	60

* dimension in inches, ** dimension in mm, *** dimension in degrees

LEVEL 1.0

NEW



SKU	SIZE	COLOUR	FINISH
KRLV1Z29X16M007016	S	green	mat
KRLV1Z29X17M007018	M	green	mat
KRLV1Z29X19M007020	L	green	mat
KRLV1Z29X20M007022	XL	green	mat
KRLV1Z29X22M007024	XXL	green	mat
KRLV1Z29X16M007017	S	black	gloss
KRLV1Z29X17M007019	M	black	gloss
KRLV1Z29X19M007021	L	black	gloss
KRLV1Z29X20M007023	XL	black	gloss
KRLV1Z29X22M007025	XXL	black	gloss

GEAR RATIO 2 x 8

WHEEL DIAMETER 29"

COLOUR VARIANTS



FRAME

FRAME	ALUMINIUM 6061
FORK	SR SUNTOUR XCT30 HLO
FORK TRAVEL	100 mm
SIZES	S(16"), M(17"), L(19"), XL(20"), XXL(22")

DRIVETRAIN

FRONT DERAILLEUR	SHIMANO ALTUS M315
REAR DERAILLEUR	SHIMANO ACERA M360
FRONT BRAKE	SHIMANO MT200
REAR BRAKE	SHIMANO MT200
BRAKE LEVERS	SHIMANO MT200
BRAKE DISCS	SHIMANO RT10 180 CL
SHIFTERS	SHIMANO M315
CRANKSET	WHEELTOP TM-CY10
SPROCKETS	36T-22T/170 mm
BOTTOM BRACKET	FP-B902
CHAIN	YBN S8
CASSETTE/FREEWHEEL	SHIMANO ACERA HG41
CASSETTE/FREEWHEEL RANGE	11-34T

WHEELS

FRONT HUB	SHIMANO MT200
REAR HUB	SHIMANO ALTUS MT200
RIMS	KROSS ALUMINIUM 622 x 25
TIRES	SCHWALBE SMART SAM 29 x 2,25

COMPONENTS

HANDLEBAR	ALUMINIUM 740 mm 31.8
HANDLEBAR STEM	ALUMINIUM 70 mm/31,8/17°
SEAT POST	ALUMINIUM 27,2 x 350 mm
HEADSET	FP-H816 O1-1/8"
SADDLE	SELLE ROYAL VIVO PU
GRIPS	PROPALM SCALE
PEDALS	FP-917N

GEOMETRY

SIZE	S	M	L	XL	XXL
FS - FRAME SIZE*	16	17	19	20	22
ST - SEAT TUBE LENGTH**	400	440	470	520	560
TT - TOP TUBE LENGTH**	568	592	616	640	664
HT - HEAD TUBE LENGTH**	100	110	125	140	155
SA - SEAT TUBE ANGLE***	74	74	74	74	74
HA - HEAD TUBE ANGLE***	69	69	69	69	69
CS - CHAINSTAY LENGTH**	445	445	445	445	445
WB - WHEELBASE**	1085	1125	1150	1175	1197
REACH**	393	415	435	455	475
STACK**	609	619	633	647	661
BB DROP**	60	60	60	60	60

* dimension in inches, ** dimension in mm, *** dimension in degrees

LEVEL 1.0



SKU	SIZE	COLOUR	FINISH
KRLV1Z29X16M006425	S	red-black	gloss
KRLV1Z29X17M006422	M	red-black	gloss
KRLV1Z29X19M006420	L	red-black	gloss
KRLV1Z29X20M006428	XL	red-black	gloss
KRLV1Z29X22M006430	XXL	red-black	gloss
KRLV1Z29X17M006421	M	black-orange	gloss
KRLV1Z29X19M006418	L	black-orange	gloss
KRLV1Z29X20M006426	XL	black-orange	gloss
KRLV1Z29X22M006429	XXL	black-orange	gloss

GEAR RATIO 2 x 9

WHEEL DIAMETER 29"

COLOUR VARIANTS



FRAME

FRAME	ALUMINIUM LITE
FORK	SR SUNTOUR XCT30
FORK TRAVEL	100 mm
SIZES	S(16"), M(17"), L(19"), XL(20"), XXL(22")

DRIVETRAIN

FRONT DERAILLEUR	SHIMANO ALTUS M2020
REAR DERAILLEUR	SHIMANO ALTUS M2000
FRONT BRAKE	SRAM LEVEL
REAR BRAKE	SRAM LEVEL
BRAKE LEVERS	SRAM LEVEL
BRAKE DISCS	SHIMANO RT10 160 CL
SHIFTERS	SHIMANO ALTUS M2010
CRANKSET	SHIMANO MT101
SPROCKETS	36-22T/175 mm
BOTTOM BRACKET	FP-B902
CHAIN	SHIMANO HG53
CASSETTE/FREEWHEEL	SHIMANO ALTUS HG200
CASSETTE/FREEWHEEL RANGE	11-36T

WHEELS

FRONT HUB	MT200
REAR HUB	MT200-B
RIMS	KROSS ALUMINIUM 622 x 19
TIRES	SCHWALBE SMART SAM 29 x 2,25

COMPONENTS

HANDLEBAR	ALUMINIUM 720 mm 31.8
HANDLEBAR STEM	ALUMINIUM 70 mm/31,8/17°
SEAT POST	ALUMINIUM 27,2 x 350 mm
HEADSET	FP-H816 O1-1/8"
SADDLE	SELLE ROYAL VIVO PU
GRIPS	KROSS SCALE
PEDALS	FP-917N

GEOMETRY

SIZE	S	M	L	XL	XXL
FS - FRAME SIZE*	16	17	19	20	22
ST - SEAT TUBE LENGTH**	400	440	470	520	560
TT - TOP TUBE LENGTH**	568	592	616	640	664
HT - HEAD TUBE LENGTH**	100	110	125	140	155
SA - SEAT TUBE ANGLE***	74	74	74	74	74
HA - HEAD TUBE ANGLE***	69	69	69	69	69
CS - CHAINSTAY LENGTH**	445	445	445	445	445
WB - WHEELBASE**	1085	1125	1150	1175	1197
REACH**	393	415	435	455	475
STACK**	609	619	633	647	661
BB DROP**	60	60	60	60	60

* dimension in inches, ** dimension in mm, *** dimension in degrees

HEXAGON, LEA

NEW GENERATION

A completely new Hexagon and Lea line has everything that beginners or simply pragmatic MTB users need in a modern bike.

A clear offering for every budget, with 7 models to choose from in both women's and men's versions. 2 Models come fully equipped with accessories to facilitate daily bike usage (Hexagon 4.0 EQ & 2.0 EQ, Lea 4.0 EQ & 2.0 EQ models).

The new models include:

- » New frame geometry, suitable for sporting and recreational use (models 5.0-2.0).
- » Lower top tube for easier getting on and greater safety (models 5.0-2.0).
- » 100 mm fork travel to complement the advantages of the new frame geometry and off-road capabilities (models 5.0-2.0).
- » 27.5" or 29" wheels depending on frame size (models 5.0-2.0).
- » Full internal cable routing for aesthetic appeal and less maintenance (models 5.0-2.0).
- » The option to purchase a bike with smaller 26" wheels and v-brakes in a refreshed version (model 1.0).
- » Modern design with two color options for each model.



HEXAGON, LEA

PORTFOLIO 2024

HEXAGON 8.0

HEXAGON 7.0

HEXAGON 6.0

HEXAGON 5.0

HEXAGON 3.0

HEXAGON 2.0

HEXAGON 1.0

HEXAGON



NEW GENERATION

HEXAGON /LEA 5.0

HEXAGON /LEA 4.0 EQ

HEXAGON /LEA 4.0

HEXAGON /LEA 3.0

HEXAGON /LEA 2.0 EQ

HEXAGON /LEA 2.0

HEXAGON /LEA 1.0

HEXAGON, LEA EQUIPPED MODELS



HEXAGON 5.0

NEW



SKU	SIZE	COLOUR	FINISH
KRHE5Z27X15M006876	S/27,5"	gray	gloss
KRHE5Z27X17M006878	M/27,5"	gray	gloss
KRHE5Z29X17M006880	M/29"	gray	gloss
KRHE5Z29X18M006882	L/29"	gray	gloss
KRHE5Z29X20M006884	XL/29"	gray	gloss
KRHE5Z29X21M006886	XXL/29"	gray	gloss
KRHE5Z27X15M006877	S/27,5"	black	gloss
KRHE5Z27X17M006879	M/27,5"	black	gloss
KRHE5Z29X17M006881	M/29"	black	gloss
KRHE5Z29X18M006883	L/29"	black	gloss
KRHE5Z29X20M006885	XL/29"	black	gloss
KRHE5Z29X21M006887	XXL/29"	black	gloss

GEAR RATIO 2 x 9
WHEEL DIAMETER 27,5"/29"
COLOUR VARIANTS



FRAME

FRAME	ALUMINIUM
FORK	SR SUNTOUR XCM RL
FORK TRAVEL	100 mm
SIZES	S(15"), M(17"), L(18"), XL(20"), XXL(21")

DRIVETRAIN

FRONT DERAILLEUR	SHIMANO CUES U 4000
REAR DERAILLEUR	SIMANO CUES RD U3020
FRONT BRAKE	SHIMANO MT200
REAR BRAKE	SHIMANO MT200
BRAKE LEVERS	SHIMANO MT200
BRAKE DISCS	DISC (160 mm)
SHIFTERS	SHIMANO CUES U4000
CRANKSET	SHIMANO FC-U4000 CUES
SPROCKETS	36T-22T/170 mm
BOTTOM BRACKET	SHIMANO BSA BB-UN101
CHAIN	SHIMANO LG500
CASSETTE/FREEWHEEL	SHIMANO CUES LG300
CASSETTE/FREEWHEEL RANGE	11-36T

WHEELS

FRONT HUB	GL-B43F-DS
REAR HUB	GL-B43R-DS
RIMS	KROSS ALUMINIUM 19C
TIRES	MIKE BEAR 2,25

COMPONENTS

HANDLEBAR	ALUMINIUM 680 mm 31.8
HANDLEBAR STEM	ALUMINIUM 75 mm/31,8/7°
SEAT POST	ALUMINIUM 30,9 x 300-350 mm
HEADSET	FP-H863 O1-1/8"
SADDLE	YIBOTONG YBT-K610F046
GRIPS	PROPALM SCALE
PEDALS	FP-917N

GEOMETRY

SIZE	S/27,5"	M/27,3"	M/29"	L/29"	XL/29"	XXL/29"
FS - FRAME SIZE*	15	17	17	18	20	21
ST - SEAT TUBE LENGTH**	380	420	420	460	500	530
TT - TOP TUBE LENGTH**	562	590	595	617	639	657
HT - HEAD TUBE LENGTH**	110	120	115	120	130	140
SA - SEAT TUBE ANGLE***	74	74	74	74	74	74
HA - HEAD TUBE ANGLE***	68	68	68	68	68	68
CS - CHAINSTAY LENGTH**	435	439	450	450	450	450
WB - WHEELBASE**	390	415	415	435	455	470
REACH**	600	609	628	633	642	652
STACK**	1190	1118	1136	1158	1182	1200
BB DROP**	50	50	60	60	60	60

* dimension in inches, ** dimension in mm, *** dimension in degrees

HEXAGON 4.0 EQ

NEW



FRAME

FRAME	ALUMINIUM
FORK	SR SUNTOUR NVX
FORK TRAVEL	100 mm
SIZES	S(15"), M(17"), L(16"), XL(20"), XXL(21")

DRIVETRAIN

FRONT DERAILLEUR	SHIMANO ALTUS M315
REAR DERAILLEUR	SHIMANO ACERA M360
FRONT BRAKE	SHIMANO MT200
REAR BRAKE	SHIMANO MT200
BRAKE LEVERS	SHIMANO MT200
BRAKE DISCS	POWER RT600 160 6B
SHIFTERS	SHIMANO M315
CRANKSET	WHEELTOP TM-CY10
SPROCKETS	36T-22T/170 mm
BOTTOM BRACKET	FP-B902
CHAIN	YBN S8
CASSETTE/FREEWHEEL	SHIMANO ACERA HG41
CASSETTE/FREEWHEEL RANGE	11-34T

WHEELS

FRONT HUB	GULI GL-B43F
REAR HUB	GULI GL-B43R
RIMS	KROSS ALUMINIUM
TIRES	WANDA MIKE BEAR

COMPONENTS

HANDLEBAR	ALUMINIUM 680 mm 31.8
HANDLEBAR STEM	ALUMINIUM 75 mm/31,8/7°
SEAT POST	ALUMINIUM 30,9 x 300 mm
HEADSET	FP-H863 O1-1/8"
SADDLE	YIBOTONG YBT-K610F046
GRIPS	PROPALM HANDY
CARRIER	STANDWELL ALLOY CARRY MORE SYSTEM
FRONT LIGHT	BUHEL AHEAD 35
REAR LIGHT	AXA JUNO
MUDGUARDS	PLASTIC
KICK STAND	REAR MARABOU II

SKU	SIZE	COLOUR	FINISH
KRHE4E27X15M006864	S/27,5"	green	gloss
KRHE4E27X17M006866	M/27,5"	green	gloss
KRHE4E29X17M006868	M/29"	green	gloss
KRHE4E29X18M006870	L/29"	green	gloss
KRHE4E29X20M006872	XL/29"	green	gloss
KRHE4E29X21M006874	XXL/29"	green	gloss
KRHE4E27X15M006865	S/27,5"	gray	gloss
KRHE4E27X17M006867	M/27,5"	gray	gloss
KRHE4E29X17M006869	M29"	gray	gloss
KRHE4E29X18M006871	L/29"	gray	gloss
KRHE4E29X20M006873	XL/29"	gray	gloss
KRHE4E29X21M006875	XXL/29"	gray	gloss

GEAR RATIO 2 x 8
WHEEL DIAMETER 27,5"/29"
COLOUR VARIANTS



GEOMETRY

SIZE	S/27,5"	M/27,5"	M/29"	L/29"	XL/29"	XXL/29"
FS - FRAME SIZE*	15	17	17	18	20	21
ST - SEAT TUBE LENGTH**	380	420	420	460	500	530
TT - TOP TUBE LENGTH**	562	590	595	617	639	657
HT - HEAD TUBE LENGTH**	110	120	115	120	130	140
SA - SEAT TUBE ANGLE***	74	74	74	74	74	74
HA - HEAD TUBE ANGLE***	68	68	68	68	68	68
CS - CHAINSTAY LENGTH**	435	435	450	450	450	450
WB - WHEELBASE**	390	415	415	435	455	470
REACH**	600	609	628	633	642	652
STACK**	1090	1118	1136	1158	1182	1200
BB DROP**	50	50	60	60	60	60

* dimension in inches, ** dimension in mm, *** dimension in degrees

HEXAGON 4.0

NEW



SKU	SIZE	COLOUR	FINISH
KRHE4Z27X15M007617	S/27.5"	blue-black	gloss
KRHE4Z27X17M007618	M/27.5"	blue-black	gloss
KRHE4Z29X17M007621	M/29"	blue-black	gloss
KRHE4Z29X18M007622	L/29"	blue-black	gloss
KRHE4Z29X20M007623	XL/29"	blue-black	gloss
KRHE4Z29X21M007624	XXL/29"	blue-black	gloss
KRHE4Z27X15M007619	S/27.5"	red-silver	gloss
KRHE4Z27X17M007620	M/27.5"	red-silver	gloss
KRHE4Z29X17M007625	M/29"	red-silver	gloss
KRHE4Z29X18M007626	L/29"	red-silver	gloss
KRHE4Z29X20M007627	XL/29"	red-silver	gloss
KRHE4Z29X21M007628	XXL/29"	red-silver	gloss

GEAR RATIO 2 x 8
WHEEL DIAMETER 27,5"/29"
COLOUR VARIANTS

FRAME

FRAME	ALUMINIUM
FORK	SR SUNTOUR NVX
FORK TRAVEL	100 mm
SIZES	S(15"), M(17"), L(18"), XL(20"), XXL(21")

DRIVETRAIN

FRONT DERAILLEUR	SHIMANO ALTUS M315
REAR DERAILLEUR	SHIMANO ACERA M360
FRONT BRAKE	SHIMANO MT200
REAR BRAKE	SHIMANO MT200
BRAKE LEVERS	SHIMANO MT200
BRAKE DISCS	DISC (160 mm)
SHIFTERS	SHIMANO M315
CRANKSET	WHEELTOP TM-CY10
SPROCKETS	36T-22T/170 mm
BOTTOM BRACKET	FP-B902
CHAIN	YBN S8
CASSETTE/FREEWHEEL	SHIMANO ACERA HG41
CASSETTE/FREEWHEEL RANGE	11-34T

WHEELS

FRONT HUB	GL-B43F-DS
REAR HUB	GL-B43R-DS
RIMS	KROSS ALUMINIUM 19C
TIRES	MIKE BEAR 2,25

COMPONENTS

HANDLEBAR	ALUMINIUM 680 mm 31.8
HANDLEBAR STEM	ALUMINIUM 75 mm/31,8/7°
SEAT POST	ALUMINIUM 30,9 x 300 mm
HEADSET	FP-H863 O1-1/8"
SADDLE	YIBOTONG YBT-K610F046
GRIPS	PROPALM HANDY
PEDALS	FP-804

GEOMETRY

SIZE	S/27,5"	M/27,5"	M/29"	L/29"	XL/29"	XXL/29"
FS - FRAME SIZE*	15	17	17	18	20	21
ST - SEAT TUBE LENGTH**	380	420	420	460	500	530
TT - TOP TUBE LENGTH**	562	590	595	617	639	657
HT - HEAD TUBE LENGTH**	110	120	115	120	130	140
SA - SEAT TUBE ANGLE***	74	74	74	74	74	74
HA - HEAD TUBE ANGLE***	68	68	68	68	68	68
CS - CHAINSTAY LENGTH**	435	435	450	450	450	450
WB - WHEELBASE**	390	415	415	435	455	470
REACH**	600	609	628	633	642	652
STACK**	1090	1118	1136	1158	1182	1200
BB DROP**	50	50	60	60	60	60

* dimension in inches, ** dimension in mm, *** dimension in degrees

HEXAGON 3.0

NEW



SKU	SIZE	COLOUR	FINISH
KRHE3Z27X15M006840	S/27,5"	gray	gloss
KRHE3Z27X17M006842	M/27,5"	gray	gloss
KRHE3Z29X17M006844	M/29"	gray	gloss
KRHE3Z29X18M006846	L/29"	gray	gloss
KRHE3Z29X20M006848	XL/29"	gray	gloss
KRHE3Z29X21M006850	XXL/29"	gray	gloss
KRHE3Z27X15M007611	S/27,5"	khaki	gloss
KRHE3Z27X17M007612	M/27,5"	khaki	gloss
KRHE3Z29X17M007613	M/29"	khaki	gloss
KRHE3Z29X18M007614	L/29"	khaki	gloss
KRHE3Z29X20M007615	XL/29"	khaki	gloss
KRHE3Z29X21M007616	XXL/29"	khaki	gloss

GEAR RATIO 3 x 8
WHEEL DIAMETER 27,5"/29"
COLOUR VARIANTS



FRAME

FRAME	ALUMINIUM
FORK	KROSS
FORK TRAVEL	100 mm
SIZES	S(15"), M(17"), L(18"), XL(20"), XXL(21")

DRIVETRAIN

FRONT DERAILLEUR	SHIMANO ALTUS M315
REAR DERAILLEUR	SHIMANO ACERA M360
FRONT BRAKE	MECHANICAL DISC
REAR BRAKE	MECHANICAL DISC
BRAKE LEVERS	ALUMINIUM
BRAKE DISCS	DISC (160 mm)
SHIFTERS	SHIMANO M315
CRANKSET	WHEELTOP TM-CY10
SPROCKETS	36T-22T/170 mm
BOTTOM BRACKET	FP-B902
CHAIN	YBN S8
CASSETTE/FREEWHEEL	SHIMANO ACERA HG41
CASSETTE/FREEWHEEL RANGE	11-34T

WHEELS

FRONT HUB	GL-B43F-DS
REAR HUB	GL-B43R-DS
RIMS	KROSS ALUMINIUM 19C
TIRES	WANDA P1288 2,25

COMPONENTS

HANDLEBAR	ALUMINIUM 660 mm 31,8
HANDLEBAR STEM	ALUMINIUM 75 mm/31,8/7°
SEAT POST	ALUMINIUM 30,9 x 300-350 mm
HEADSET	FP-H863 O1-1/8"
SADDLE	YIBOTONG YBT-K610F046
GRIPS	PROPALM HANDY
PEDALS	FP-804

GEOMETRY

SIZE	S/27,5"	M/27,5"	M/29"	L/29"	XL/29"	XXL/29"
FS - FRAME SIZE*	15	17	17	18	20	21
ST - SEAT TUBE LENGTH**	380	420	420	460	500	530
TT - TOP TUBE LENGTH**	562	590	595	617	639	657
HT - HEAD TUBE LENGTH**	110	120	115	120	130	140
SA - SEAT TUBE ANGLE***	74	74	74	74	74	74
HA - HEAD TUBE ANGLE***	68	68	68	68	68	68
CS - CHAINSTAY LENGTH**	435	435	450	450	450	450
WB - WHEELBASE**	390	415	415	435	455	470
REACH**	600	609	628	633	642	652
STACK**	1090	1118	1136	1158	1182	1200
BB DROP**	50	50	60	60	60	60

* dimension in inches, ** dimension in mm, *** dimension in degrees

HEXAGON 2.0 EQ

NEW



FRAME

FRAME	ALUMINIUM
FORK	KROSS
FORK TRAVEL	100 mm
SIZES	S(15"), M(17"), L(16"), XL(20"), XXL(21")

DRIVETRAIN

FRONT DERAILLEUR	SHIMANO TOURNEY TY300
REAR DERAILLEUR	SHIMANO ALTUS M310
FRONT BRAKE	MECHANICAL DISC
REAR BRAKE	MECHANICAL DISC
BRAKE LEVERS	SHIMANO TOURNEY ST-EF41
BRAKE DISCS	DISC (160 mm)
SHIFTERS	SHIMANO TOURNEY ST-EF41
CRANKSET	WHEEL TOP TCSH4-CFPG
SPROCKETS	42T-34T-24T/170 mm
BOTTOM BRACKET	FP-B902
CHAIN	KMC HV500
CASSETTE/FREEWHEEL	SHIMANO TOURNEY MF-TZ500
CASSETTE/FREEWHEEL RANGE	14-28T

WHEELS

FRONT HUB	GULI GL-B01F
REAR HUB	GULI GL-B10R
RIMS	KROSS ALUMINIUM 584 x 19
TIRES	KROSS P1255 29/27,5 x 2,1

COMPONENTS

HANDLEBAR	ALUMINIUM 660 mm 31,8
HANDLEBAR STEM	ALUMINIUM 75 mm/31,8/7°
SEAT POST	ALUMINIUM 30,9 x 300 mm
HEADSET	FP-H863 O1-1/8"
SADDLE	YIBOTONG YBT-K610F046
GRIPS	PROPALM HANDY
CARRIER	STANDWELL ALLOY CARRY MORE SYSTEM
FRONT LIGHT	BUHEL AHEAD 35
REAR LIGHT	AXA JUNO
MUDGUARDS	PLASTIC
KICK STAND	REAR MARABOU II

SKU	SIZE	COLOUR	FINISH
KRHE2E27X15M006781	S/27,5"	gray	gloss
KRHE2E27X17M006783	M/27,5"	gray	gloss
KRHE2E29X17M006785	M/29"	gray	gloss
KRHE2E29X18M006787	L/29"	gray	gloss
KRHE2E29X20M006789	XL/29"	gray	gloss
KRHE2E29X21M006791	XXL/29"	gray	gloss
KRHE2E27X15M007605	S/27,5"	bordowy	gloss
KRHE2E27X17M007606	M/27,5"	bordowy	gloss
KRHE2E29X17M007607	M/29"	bordowy	gloss
KRHE2E29X18M007608	L/29"	bordowy	gloss
KRHE2E29X20M007609	XL/29"	bordowy	gloss
KRHE2E29X21M007610	XXL/29"	bordowy	gloss

GEAR RATIO 3 x 7
WHEEL DIAMETER 27,5"/29"
COLOUR VARIANTS



GEOMETRY

SIZE	S/27,5"	M/27,5"	M29"	L/29"	XL/29"	XXL/29"
FS - FRAME SIZE*	15	17	17	18	20	21
ST - SEAT TUBE LENGTH**	380	420	420	460	500	530
TT - TOP TUBE LENGTH**	562	590	595	617	639	657
HT - HEAD TUBE LENGTH**	110	120	115	120	130	140
SA - SEAT TUBE ANGLE***	74	74	74	74	74	74
HA - HEAD TUBE ANGLE***	68	68	68	68	68	68
CS - CHAINSTAY LENGTH**	435	435	450	450	450	450
WB - WHEELBASE**	390	415	415	435	455	470
REACH**	600	609	628	633	642	652
STACK**	1090	1118	1136	1158	1182	1200
BB DROP**	50	50	60	60	60	60

* dimension in inches, ** dimension in mm, *** dimension in degrees

HEXAGON 2.0

NEW



SKU	SIZE	COLOUR	FINISH
KRHE2Z27X15M006769	S/27,5"	dark green	gloss
KRHE2Z27X17M006771	M/27,5"	dark green	gloss
KRHE2Z29X17M006773	M/29"	dark green	gloss
KRHE2Z29X18M006775	L/29"	dark green	gloss
KRHE2Z29X20M006777	XL/29"	dark green	gloss
KRHE2Z29X21M006779	XXL/29"	dark green	gloss
KRHE2Z27X15M007599	S/27,5"	green	gloss
KRHE2Z27X17M007600	M/27,5"	green	gloss
KRHE2Z29X17M007601	M/29"	green	gloss
KRHE2Z29X18M007602	L/29"	green	gloss
KRHE2Z29X20M007603	XL/29"	green	gloss
KRHE2Z29X21M007604	XXL/29"	green	gloss

GEAR RATIO 3 x 7
WHEEL DIAMETER 27,5"/29"
COLOUR VARIANTS



FRAME

FRAME	ALUMINIUM
FORK	KROSS
FORK TRAVEL	100 mm
SIZES	S(15"), M(17"), L(18"), XL(20"), XXL(21")

DRIVETRAIN

FRONT DERAILLEUR	SHIMANO TOURNEY TY300
REAR DERAILLEUR	SHIMANO ALTUS M310
FRONT BRAKE	MECHANICAL DISC
REAR BRAKE	MECHANICAL DISC
BRAKE LEVERS	SHIMANO TOURNEY ST-EF41
BRAKE DISCS	DISC (160 mm)
SHIFTERS	SHIMANO TOURNEY ST-EF41
CRANKSET	WHEEL TOP TCSH4-CFPG
SPROCKETS	42T-34T-24T/170 mm
BOTTOM BRACKET	FP-B902
CHAIN	KMC HV500
CASSETTE/FREEWHEEL	SHIMANO TOURNEY MF-TZ500
CASSETTE/FREEWHEEL RANGE	14-28T

WHEELS

FRONT HUB	GL-B01F-QR
REAR HUB	GL-B10R-DS
RIMS	KROSS ALUMINIUM 19C
TIRES	WANDA P1288 2,25

COMPONENTS

HANDLEBAR	ALUMINIUM 660 mm 31,8
HANDLEBAR STEM	ALUMINIUM 75 mm/31,8/7°
SEAT POST	ALUMINIUM 30,9 x 300-350 mm
HEADSET	FP-H863 O1-1/8"
SADDLE	YIBOTONG YBT-K610F046
GRIPS	PROPALM HANDY
PEDALS	FP-804

GEOMETRY

SIZE	S/27,5"	M/27,5"	M/29"	L/29"	XL/29"	XXL/29"
FS - FRAME SIZE*	15	17	17	18	20	21
ST - SEAT TUBE LENGTH**	380	420	420	460	500	530
TT - TOP TUBE LENGTH**	562	590	595	617	639	657
HT - HEAD TUBE LENGTH**	110	120	115	120	130	140
SA - SEAT TUBE ANGLE***	74	74	74	74	74	74
HA - HEAD TUBE ANGLE***	68	68	68	68	68	68
CS - CHAINSTAY LENGTH**	435	435	450	450	450	450
WB - WHEELBASE**	390	415	415	435	455	470
REACH**	600	609	628	633	642	652
STACK**	1090	1118	1136	1158	1182	1200
BB DROP**	50	50	60	60	60	60

* dimension in inches, ** dimension in mm, *** dimension in degrees

HEXAGON 1.0

NEW



SKU	SIZE	COLOUR	FINISH
KRHE1Z26X14M006763	XS	blue	gloss
KRHE1Z26X17M006765	S	blue	gloss
KRHE1Z26X19M006767	M	blue	gloss
KRHE1Z26X14M006764	XS	orange	gloss
KRHE1Z26X17M006766	S	orange	gloss
KRHE1Z26X19M006768	M	orange	gloss

GEAR RATIO 3 x 7

WHEEL DIAMETER 26"

COLOUR VARIANTS



FRAME

FRAME	ALUMINIUM
FORK	KROSS
FORK TRAVEL	80 mm
SIZES	XS(14"), S(17"), M(19")

DRIVETRAIN

FRONT DERAILLEUR	SHIMANO TOURNEY TZ500
REAR DERAILLEUR	SHIMANO TOURNEY TX800
FRONT BRAKE	V-BRAKE
REAR BRAKE	V-BRAKE
BRAKE LEVERS	ALUMINIUM
SHIFTERS	SHIMANO RS36 REVOSHIFT
CRANKSET	WHEEL TOP TCSH4-CFPG
SPROCKETS	42T-34T-24T/170 mm
BOTTOM BRACKET	FP-B902
CHAIN	YBN S50
CASSETTE/FREEWHEEL	SHIMANO TOURNEY MF-TZ500
CASSETTE/FREEWHEEL RANGE	14-28T

WHEELS

FRONT HUB	GL-B01F-QR
REAR HUB	GL-B01R
RIMS	KROSS ALUMINIUM 19C
TIRES	WANDA P1255 2,1

COMPONENTS

HANDLEBAR	ALUMINIUM 660 mm 31,8
HANDLEBAR STEM	ALUMINIUM 75 mm/31,8/7°
SEAT POST	ALUMINIUM 27,2 x 300-350 mm
HEADSET	FP-H863 O1-1/8"
SADDLE	YIBOTONG YBT-K610F046
GRIPS	HERMANS 89A
PEDALS	FP-804

GEOMETRY

SIZE	XS	S	M
FS - FRAME SIZE*	14	17	19
ST - SEAT TUBE LENGTH**	360	440	480
TT - TOP TUBE LENGTH**	550	570	585
HT - HEAD TUBE LENGTH**	120	120	135
SA - SEAT TUBE ANGLE***	73	73	73
HA - HEAD TUBE ANGLE***	71	71	71
CS - CHAINSTAY LENGTH**	430	430	430
WB - WHEELBASE**	1030	1050	1066
REACH**	373	393	404
STACK**	579	579	593
BB DROP**	35	35	35

* dimension in inches, ** dimension in mm, *** dimension in degrees

HEXAGON 8.0



GEAR RATIO 2 x 9

WHEEL DIAMETER 29"

COLOUR VARIANTS



SKU	SIZE	COLOUR	FINISH
KRHE8Z29X17M005484	S	navy blue-white-gray	mat
KRHE8Z29X21M005486	L	navy blue-white-gray	mat
KRHE8Z29X23M005487	XL	navy blue-white-gray	mat

FRAME

FRAME	ALUMINIUM PERFORMANCE
FORK	SR SUNTOUR XCR 32 AIR RLR
FORK TRAVEL	100 mm
SIZES	S(17"), L(21"), XL(23")

DRIVETRAIN

FRONT DERAILLEUR	SHIMANO ALTUS M2020
REAR DERAILLEUR	SHIMANO DEORE M592
FRONT BRAKE	POWER BH-M960
REAR BRAKE	POWER BH-M960
BRAKE LEVERS	POWER BH-M960
BRAKE DISCS	DISC (160 mm)
SHIFTERS	SHIMANO ALIVIO M3100
CRANKSET	SHIMANO MT101-2
SPROCKETS	36T-22T/175 mm
BOTTOM BRACKET	SHIMANO BSA BB-UN101
CHAIN	SHIMANO HG53
CASSETTE/FREEWHEEL	SHIMANO HG200
CASSETTE/FREEWHEEL RANGE	11-36T

WHEELS

FRONT HUB	GL-B43F-DS
REAR HUB	GL-B43R-DS
RIMS	KROSS ALUMINIUM 19C
TIRES	WANDA P1255 2,1

COMPONENTS

HANDLEBAR	ALUMINIUM 680 mm 31,8
HANDLEBAR STEM	ALUMINIUM 75 mm/31,8/7°
SEAT POST	ALUMINIUM 27,2 x 300-350 mm
HEADSET	1-1/8"
SADDLE	YIBOTONG K-SAN YBT-6035F140
GRIPS	KROSS SCALE
PEDALS	FP-917N

GEOMETRY

SIZE	S	L	XL
FS - FRAME SIZE*	17	21	23
ST - SEAT TUBE LENGTH**	430	530	580
TT - TOP TUBE LENGTH**	586	627	640
HT - HEAD TUBE LENGTH**	120	140	160
SA - SEAT TUBE ANGLE***	72,5	72,5	72,5
HA - HEAD TUBE ANGLE***	69	69	69
CS - CHAINSTAY LENGTH**	444	444	444
WB - WHEELBASE**	1095	1138	1152
REACH**	385	420	428
STACK**	636	655	674
BB DROP**	60	60	60

* dimension in inches, ** dimension in mm, *** dimension in degrees

HEXAGON 7.0



SKU	SIZE	COLOUR	FINISH
KRHE7Z29X17M003584	S	graphite-white-black	gloss
KRHE7Z29X19M003585	M	graphite-white-black	gloss
KRHE7Z29X21M003586	L	graphite-white-black	gloss
KRHE7Z29X23M003587	XL	graphite-white-black	gloss

GEAR RATIO 2 x 9

WHEEL DIAMETER 29"

COLOUR VARIANTS



FRAME

FRAME	ALUMINIUM PERFORMANCE
FORK	SR SUNTOUR XCM RL
FORK TRAVEL	100 mm
SIZES	S(17"), M(19"), L(21"), XL(23")

DRIVETRAIN

FRONT DERAILLEUR	SHIMANO ALTUS M2020
REAR DERAILLEUR	SHIMANO DEORE M592
FRONT BRAKE	SHIMANO MT200
REAR BRAKE	SHIMANO MT200
BRAKE LEVERS	SHIMANO MT200
BRAKE DISCS	DISC (160 mm)
SHIFTERS	SHIMANO ALTUS M2010
CRANKSET	SHIMANO MT101-2
SPROCKETS	36T-22T/175 mm
BOTTOM BRACKET	SHIMANO BSA BB-UN101
CHAIN	SHIMANO HG53
CASSETTE/FREEWHEEL	SHIMANO HG200
CASSETTE/FREEWHEEL RANGE	11-36T

WHEELS

FRONT HUB	GL-B43F-DS
REAR HUB	GL-B43R-DS
RIMS	KROSS ALUMINIUM 19C
TIRES	WANDA P1255 2,1

COMPONENTS

HANDLEBAR	ALUMINIUM 680 mm 31,8
HANDLEBAR STEM	ALUMINIUM 75-105 mm/31,8/7°
SEAT POST	ALUMINIUM 27,2 x 300-350 mm
HEADSET	1-1/8"
SADDLE	YIBOTONG K-SAN YBT-6035F140
GRIPS	KROSS SCALE
PEDALS	FP-917N

GEOMETRY

SIZE	S	M	L	XL
FS - FRAME SIZE*	17	19	21	23
ST - SEAT TUBE LENGTH**	430	480	530	580
TT - TOP TUBE LENGTH**	586	609	627	640
HT - HEAD TUBE LENGTH**	120	130	140	160
SA - SEAT TUBE ANGLE***	72,5	72,5	72,5	72,5
HA - HEAD TUBE ANGLE***	69	69	69	69
CS - CHAINSTAY LENGTH**	444	444	444	444
WB - WHEELBASE**	1095	1119	1138	1152
REACH**	385	405	420	428
STACK**	636	646	655	674
BB DROP**	60	60	60	60

* dimension in inches, ** dimension in mm, *** dimension in degrees

HEXAGON 6.0



SKU	SIZE	COLOUR	FINISH
KRHE6Z27X15M003582	XS/27,5"	black-grey-graphite	gloss
KRHE6Z27X17M003583	S/27,5"	black-grey-graphite	gloss
KRHE6Z29X17M003578	S/29"	black-grey-graphite	gloss
KRHE6Z29X19M003579	M/29"	black-grey-graphite	gloss
KRHE6Z29X23M003581	XL/29"	black-grey-graphite	gloss

GEAR RATIO 3 x 8
WHEEL DIAMETER 27,5"/29"
COLOUR VARIANTS



FRAME

FRAME	ALUMINIUM PERFORMANCE
FORK	SR SUNTOUR XCM RL
FORK TRAVEL	100 mm
SIZES	XS(15"), S(17"), M(19"), XL(23")

DRIVETRAIN

FRONT DERAILLEUR	SHIMANO TOURNEY TY700
REAR DERAILLEUR	SHIMANO ACERA M360
FRONT BRAKE	SHIMANO ALTUS ST-EF505
REAR BRAKE	SHIMANO MT200
BRAKE LEVERS	SHIMANO ALTUS ST-EF505
BRAKE DISCS	DISC (160 mm)
SHIFTERS	SHIMANO ST-EF505
CRANKSET	SHIMANO TY301
SPROCKETS	42T-34T-24T/175 mm
BOTTOM BRACKET	FP-B902
CHAIN	YBN S8
CASSETTE/FREEWHEEL	SHIMANO HG200
CASSETTE/FREEWHEEL RANGE	12-32T

WHEELS

FRONT HUB	GL-B43F-DS
REAR HUB	GL-B43R-DS
RIMS	KROSS ALUMINIUM 19C
TIRES	WANDA P1255 2,1

COMPONENTS

HANDLEBAR	ALUMINIUM 680 mm 31,8
HANDLEBAR STEM	ALUMINIUM 75-105 mm/31,8/7°
SEAT POST	ALUMINIUM 27,2 x 300-350 mm
HEADSET	1-1/8"
SADDLE	YIBOTONG K-SAN YBT-6035F140
GRIPS	KROSS SCALE
PEDALS	FP-917N

GEOMETRY

SIZE	XS/27,5"	S/27,5"	S/29"	M/29"	XL/29"
FS - FRAME SIZE*	15	17	17	19	23
ST - SEAT TUBE LENGTH**	380	430	430	480	580
TT - TOP TUBE LENGTH**	555	575	586	609	640
HT - HEAD TUBE LENGTH**	115	125	120	130	160
SA - SEAT TUBE ANGLE***	72,5	72,5	72,5	72,5	72,5
HA - HEAD TUBE ANGLE***	70	70	69	69	69
CS - CHAINSTAY LENGTH**	435	435	444	444	444
WB - WHEELBASE**	1041	1048	1095	1119	1152
REACH**	29"	380	385	405	428
STACK**	610	619	636	646	674
BB DROP**	45	45	60	60	60

* dimension in inches, ** dimension in mm, *** dimension in degrees

HEXAGON 6.0



SKU	SIZE	COLOUR	FINISH
KRHE6Z27X15M005474	XS/27,5"	black-grey-graphite	gloss
KRHE6Z27X17M005475	S/27,5"	black-grey-graphite	gloss
KRHE6Z29X17M005476	S/29"	black-grey-graphite	gloss
KRHE6Z29X19M005477	M/29"	black-grey-graphite	gloss
KRHE6Z29X21M005478	L/29"	black-grey-graphite	gloss
KRHE6Z29X23M005479	XL/29"	black-grey-graphite	gloss

GEAR RATIO 3 x 8
WHEEL DIAMETER 27,5"/29"
COLOUR VARIANTS



FRAME

FRAME	ALUMINIUM PERFORMANCE
FORK	SR SUNTOUR XCM RL
FORK TRAVEL	100 mm
SIZES	XS(15"), S(17"), M(19"), L(21"), XL(23")

DRIVETRAIN

FRONT DERAILLEUR	SHIMANO TOURNEY TY700
REAR DERAILLEUR	MICROSHIFT MEZZO M36L
FRONT BRAKE	POWER BH-M960
REAR BRAKE	POWER BH-M960
BRAKE LEVERS	POWER BH-M960
BRAKE DISCS	DISC (160 mm)
SHIFTERS	MICROSHIFT MEZZO
CRANKSET	SHIMANO TY301
SPROCKETS	42T-34T-24T/175 mm
BOTTOM BRACKET	FP-B902
CHAIN	YBN S8
CASSETTE/FREEWHEEL	SHIMANO HG200
CASSETTE/FREEWHEEL RANGE	12-32T

WHEELS

FRONT HUB	GL-B43F-DS
REAR HUB	GL-B43R-DS
RIMS	KROSS ALUMINIUM 19C
TIRES	WANDA P1255 2,1

COMPONENTS

HANDLEBAR	ALUMINIUM 680 mm 31,8
HANDLEBAR STEM	ALUMINIUM 75-105 mm/31,8/7°
SEAT POST	ALUMINIUM 27,2 x 300-350 mm
HEADSET	1-1/8"
SADDLE	YIBOTONG K-SAN YBT-6035F140
GRIPS	KROSS SCALE
PEDALS	FP-917N

GEOMETRY

SIZE	XS/27,5"	S/27,5"	S/29"	M/29"	L/29"	XL/29"
FS - FRAME SIZE*	15	17	17	19	21	23
ST - SEAT TUBE LENGTH**	380	430	430	480	530	580
TT - TOP TUBE LENGTH**	555	575	586	609	627	640
HT - HEAD TUBE LENGTH**	115	125	120	130	140	160
SA - SEAT TUBE ANGLE***	72,5	72,5	72,5	72,5	72,5	72,5
HA - HEAD TUBE ANGLE***	70	70	69	69	69	69
CS - CHAINSTAY LENGTH**	435	435	444	444	444	444
WB - WHEELBASE**	1041	1048	1095	1119	1138	1152
REACH**	29"	380	385	405	420	428
STACK**	610	619	636	646	655	674
BB DROP**	45	45	60	60	60	60

* dimension in inches, ** dimension in mm, *** dimension in degrees

HEXAGON 5.0



SKU	SIZE	COLOUR	FINISH
KRHE5Z27X15M003575	XS/27,5"	black-lime-gray	gloss
KRHE5Z27X17M003577	S/27,5"	black-lime-gray	gloss
KRHE5Z29X19M003569	M/29"	black-lime-gray	gloss
KRHE5Z29X21M003571	L/29"	black-lime-gray	gloss
KRHE5Z29X23M003573	XL/29"	black-lime-gray	gloss
KRHE5Z27X17M003576	S/27,5"	red-grey-black	gloss
KRHE5Z29X17M003566	S/29"	red-grey-black	gloss
KRHE5Z29X19M003568	M/29"	red-grey-black	gloss
KRHE5Z29X21M003570	L/29"	red-grey-black	gloss
KRHE5Z29X23M003572	XL/29"	red-grey-black	gloss

GEAR RATIO 3 x 8

WHEEL DIAMETER 27,5"/29"

COLOUR VARIANTS



FRAME

FRAME	ALUMINIUM
FORK	SR SUNTOUR XCE28
FORK TRAVEL	80 mm
SIZES	S(17"), M(19"), L(21"), XL(23")

DRIVETRAIN

FRONT DERAILLEUR	SHIMANO TOURNEY TY700
REAR DERAILLEUR	SHIMANO ACERA M360
FRONT BRAKE	SHIMANO ALTUS ST-EF505
REAR BRAKE	SHIMANO MT200
BRAKE LEVERS	SHIMANO ALTUS ST-EF505
BRAKE DISCS	DISC (160 mm)
SHIFTERS	SHIMANO ST-EF505
CRANKSET	SHIMANO TY301
SPROCKETS	42T-34T-24T/175 mm
BOTTOM BRACKET	FP-B902
CHAIN	YBN S8
CASSETTE/FREEWHEEL	SHIMANO HG200
CASSETTE/FREEWHEEL RANGE	12-32T

WHEELS

FRONT HUB	GL-B43F-DS
REAR HUB	GL-B43R-DS
RIMS	KROSS ALUMINIUM 19C
TIRES	WANDA P1255 2,1

COMPONENTS

HANDLEBAR	ALUMINIUM 680 mm 31,8
HANDLEBAR STEM	ALUMINIUM 75-105 mm/31,8/7°
SEAT POST	ALUMINIUM 27,2 x 300-350 mm
HEADSET	1-1/8"
SADDLE	YIBOTONG YBT-K610F046
GRIPS	KROSS HANDY
PEDALS	FP-804

GEOMETRY

SIZE	S/27,5"	S/29"	M/29"	L/29"	XL/29"
FS - FRAME SIZE*	17	17	19	21	23
ST - SEAT TUBE LENGTH**	430	430	480	530	580
TT - TOP TUBE LENGTH**	575	586	609	627	640
HT - HEAD TUBE LENGTH**	125	120	130	140	160
SA - SEAT TUBE ANGLE***	72,5	72,5	72,5	72,5	72,5
HA - HEAD TUBE ANGLE***	70	69	69	69	69
CS - CHAINSTAY LENGTH**	435	444	444	444	444
WB - WHEELBASE**	1048	1095	1119	1138	1152
REACH**	380	385	405	420	428
STACK**	619	636	646	655	674
BB DROP**	45	60	60	60	60

* dimension in inches, ** dimension in mm, *** dimension in degrees

HEXAGON 5.0



SKU	SIZE	COLOUR	FINISH
KRHE5Z27X15M005462	XS/27,5"	red-grey-black	gloss
KRHE5Z27X17M005463	S/27,5"	red-grey-black	gloss
KRHE5Z29X17M005464	S/29"	red-grey-black	gloss
KRHE5Z29X19M005465	M/29"	red-grey-black	gloss
KRHE5Z29X21M005466	L/29"	red-grey-black	gloss
KRHE5Z29X23M005467	XL/29"	red-grey-black	gloss
KRHE5Z27X15M005468	XS/27,5"	black-lime-gray	gloss
KRHE5Z27X17M005469	S/27,5"	black-lime-gray	gloss
KRHE5Z29X17M005470	S/29"	black-lime-gray	gloss
KRHE5Z29X19M005471	M/29"	black-lime-gray	gloss
KRHE5Z29X21M005472	L/29"	black-lime-gray	gloss
KRHE5Z29X23M005473	XL/29"	black-lime-gray	gloss

GEAR RATIO 3 x 8
WHEEL DIAMETER 27,5"/29"
COLOUR VARIANTS

FRAME

FRAME	ALUMINIUM
FORK	SR SUNTOUR XCE28
FORK TRAVEL	80 mm
SIZES	XS(15"), S(17"), M(19"), L(21"), XL(23")

DRIVETRAIN

FRONT DERAILLEUR	SHIMANO TOURNEY TY700
REAR DERAILLEUR	MICROSHIFT MEZZO M36L
FRONT BRAKE	POWER BH-M960
REAR BRAKE	POWER BH-M960
BRAKE LEVERS	POWER BH-M960
BRAKE DISCS	DISC (160 mm)
SHIFTERS	MICROSHIFT MEZZO
CRANKSET	SHIMANO TY301
SPROCKETS	42T-34T-24T/175 mm
BOTTOM BRACKET	FP-B902
CHAIN	YBN S8
CASSETTE/FREEWHEEL	SHIMANO HG200
CASSETTE/FREEWHEEL RANGE	12-32T

WHEELS

FRONT HUB	GL-B43F-DS
REAR HUB	GL-B43R-DS
RIMS	KROSS ALUMINIUM 19C
TIRES	WANDA P1255 2,1

COMPONENTS

HANDLEBAR	ALUMINIUM 680 mm 31.8
HANDLEBAR STEM	ALUMINIUM 75 mm/31,8/7°
SEAT POST	ALUMINIUM 27,2 x 300-350 mm
HEADSET	1-1/8"
SADDLE	YIBOTONG YBT-K610F046
GRIPS	KROSS HANDY
PEDALS	FP-804

GEOMETRY

SIZE	XS/27,5"	S/27,5"	S/29"	M/29"	L/29"	XL/29"
FS - FRAME SIZE*	15	17	17	19	21	23
ST - SEAT TUBE LENGTH**	380	430	430	480	530	580
TT - TOP TUBE LENGTH**	555	575	586	609	627	640
HT - HEAD TUBE LENGTH**	115	125	120	130	140	160
SA - SEAT TUBE ANGLE***	72,5	72,5	72,5	72,5	72,5	72,5
HA - HEAD TUBE ANGLE***	70	70	69	69	69	69
CS - CHAINSTAY LENGTH**	435	435	444	444	444	444
WB - WHEELBASE**	1028	1048	1095	1119	1138	1152
REACH**	363	380	385	405	420	428
STACK**	610	619	636	646	655	674
BB DROP**	45	45	60	60	60	60

* dimension in inches, ** dimension in mm, *** dimension in degrees

HEXAGON 3.0



SKU	SIZE	COLOUR	FINISH
KRHE3Z26X14M004073	XS/26"	navy blue-orange-white	mat
KRHE3Z26X17M004074	S/26"	navy blue-orange-white	mat
KRHE3Z27X17M004075	S/27,5"	navy blue-orange-white	mat
KRHE3Z27X19M004076	M/27,5"	navy blue-orange-white	mat
KRHE3Z27X21M004077	L/27,5"	navy blue-orange-white	mat
KRHE3Z26X14M004078	XS/26"	graphite-blue-gray	mat
KRHE3Z26X17M004079	S/26"	graphite-blue-gray	mat
KRHE3Z27X19M004081	M/27,5"	graphite-blue-gray	mat
KRHE3Z27X21M004082	L/27,5"	graphite-blue-gray	mat

GEAR RATIO 3 x 7
WHEEL DIAMETER 26"/27,5"
COLOUR VARIANTS



FRAME

FRAME	ALUMINIUM PERFORMANCE
FORK	KROSS
FORK TRAVEL	80 mm
SIZES	XS(14"), S(17"), M(19"), L(21")

DRIVETRAIN

FRONT DERAILLEUR	SHIMANO TOURNEY TY300
REAR DERAILLEUR	SHIMANO ALTUS M310
FRONT BRAKE	MECHANICAL DISC
REAR BRAKE	MECHANICAL DISC
BRAKE LEVERS	SHIMANO TOURNEY ST-EF41
BRAKE DISCS	DISC (160 mm)
SHIFTERS	SHIMANO TOURNEY ST-EF41
CRANKSET	WHEEL TOP
SPROCKETS	42T-34T-24T/170 mm
BOTTOM BRACKET	FP-B902
CHAIN	YBN S50
CASSETTE/FREEWHEEL	SHIMANO TOURNEY MF-TZ500
CASSETTE/FREEWHEEL RANGE	14-28T

WHEELS

FRONT HUB	GL-B10F-DS
REAR HUB	GL-B10R-DS
RIMS	KROSS ALUMINIUM 19C
TIRES	WANDA P1255 2,1

COMPONENTS

HANDLEBAR	ALUMINIUM 660 mm 31,8
HANDLEBAR STEM	ALUMINIUM 75 mm/31,8/7°
SEAT POST	ALUMINIUM 27,2 x 300-350 mm
HEADSET	1-1/8"
SADDLE	YIBOTONG YBT-K610F046
GRIPS	KROSS HANDY
PEDALS	FP-804

GEOMETRY

SIZE	XS/26"	S/26"	S/27,5"	M/27,5"	L/27,5"
FS - FRAME SIZE*	14	17	17	19	21
ST - SEAT TUBE LENGTH**	370	430	430	480	530
TT - TOP TUBE LENGTH**	550	570	575	585	605
HT - HEAD TUBE LENGTH**	120	130	125	135	145
SA - SEAT TUBE ANGLE***	72,5	72,5	72,5	72,5	72,5
HA - HEAD TUBE ANGLE***	70	70	70	70	70
CS - CHAINSTAY LENGTH**	430	430	435	435	435
WB - WHEELBASE**	1036	1056	1048	1059	1079
REACH**	368	384	380	387	404
STACK**	579	588	619	629	638
BB DROP**	35	35	45	45	45

* dimension in inches, ** dimension in mm, *** dimension in degrees

HEXAGON 2.0



SKU	SIZE	COLOUR	FINISH
KRHE2Z26X14M004058	XS/26"	graphite-black-yellow	gloss
KRHE2Z26X17M004059	S/26"	graphite-black-yellow	gloss
KRHE2Z27X17M004060	S/27,5"	graphite-black-yellow	gloss
KRHE2Z27X19M004061	M/27,5"	graphite-black-yellow	gloss
KRHE2Z27X21M004062	L/27,5"	graphite-black-yellow	gloss
KRHE2Z26X14M004063	XS/26"	black-orange-gray	gloss
KRHE2Z26X17M004064	S/26"	black-orange-gray	gloss
KRHE2Z27X17M004065	S/27,5"	black-orange-gray	gloss
KRHE2Z27X19M004066	M/27,5"	black-orange-gray	gloss
KRHE2Z27X21M004067	L/27,5"	black-orange-gray	gloss
KRHE2Z26X14M004068	XS/26"	navy blue-lime-gray	mat
KRHE2Z26X17M004069	S/26"	navy blue-lime-gray	mat
KRHE2Z27X17M004070	S/27,5"	navy blue-lime-gray	mat
KRHE2Z27X19M004071	M/27,5"	navy blue-lime-gray	mat
KRHE2Z27X21M004072	L/27,5"	navy blue-lime-gray	mat

GEAR RATIO 3 x 7
WHEEL DIAMETER 26"/27,5"
COLOUR VARIANTS



FRAME

FRAME	ALUMINIUM PERFORMANCE
FORK	KROSS
FORK TRAVEL	80 mm
SIZES	XS(14")

DRIVETRAIN

FRONT DERAILLEUR	SHIMANO TOURNEY TY300
REAR DERAILLEUR	SHIMANO ALTUS M310
FRONT BRAKE	V-BRAKE
REAR BRAKE	V-BRAKE
BRAKE LEVERS	SHIMANO TOURNEY ST-EF41
SHIFTERS	SHIMANO TOURNEY ST-EF41
CRANKSET	WHEEL TOP
SPROCKETS	42T-34T-24T/170 mm
BOTTOM BRACKET	FP-B902
CHAIN	YBN S50
CASSETTE/FREEWHEEL	SHIMANO TOURNEY MF-TZ500
CASSETTE/FREEWHEEL RANGE	14-28T

WHEELS

FRONT HUB	GL-B01F-QR
REAR HUB	GL-B01R-QR
RIMS	KROSS ALUMINIUM 19C
TIRES	WANDA P1255 2,1

COMPONENTS

HANDLEBAR	ALUMINIUM 660 mm 31,8
HANDLEBAR STEM	ALUMINIUM 75-105 mm/31,8/7°
SEAT POST	ALUMINIUM 27,2 x 300-350 mm
HEADSET	1-1/8"
SADDLE	YIBOTONG YBT-K610F046
GRIPS	KROSS HANDY
PEDALS	FP-804

GEOMETRY

SIZE	XS/26"	S/26"	S/27,5"	M/27,5"	L/27,5"
FS - FRAME SIZE*	14	17	17	17	18
ST - SEAT TUBE LENGTH**	370	430	430	420	460
TT - TOP TUBE LENGTH**	550	570	575	595	617
HT - HEAD TUBE LENGTH**	120	130	125	115	120
SA - SEAT TUBE ANGLE***	72,5	72,5	72,5	74	74
HA - HEAD TUBE ANGLE***	70	70	70	68	68
CS - CHAINSTAY LENGTH**	430	430	435	450	450
WB - WHEELBASE**	1036	1056	1048	415	435
REACH**	368	384	380	628	633
STACK**	579	588	619	1136	1158
BB DROP**	35	35	45	60	60

* dimension in inches, ** dimension in mm, *** dimension in degrees

HEXAGON 1.0



SKU	SIZE	COLOUR	FINISH
KRHE1Z26X14M004046	XS	black-white-blue	gloss
KRHE1Z26X17M004047	S	black-white-blue	gloss
KRHE1Z26X19M004048	M	black-white-blue	gloss
KRHE1Z26X21M004049	L	black-white-blue	gloss
KRHE1Z26X14M004050	XS	navy blue-red-gray	mat
KRHE1Z26X17M004051	S	navy blue-red-gray	mat
KRHE1Z26X19M004052	M	navy blue-red-gray	mat
KRHE1Z26X21M004053	L	navy blue-red-gray	mat
KRHE1Z26X14M004054	XS	black-yellow-gray	gloss
KRHE1Z26X17M004055	S	black-yellow-gray	gloss
KRHE1Z26X19M004056	M	black-yellow-gray	gloss
KRHE1Z26X21M004057	L	black-yellow-gray	gloss

GEAR RATIO 3 x 7

WHEEL DIAMETER 26"

COLOUR VARIANTS



FRAME

FRAME	ALUMINIUM
FORK	KROSS
FORK TRAVEL	80 mm
SIZES	XS(14"), S(17"), M(19"), L(21")

DRIVETRAIN

FRONT DERAILLEUR	SHIMANO TOURNEY TZ500
REAR DERAILLEUR	SHIMANO TOURNEY TX800
FRONT BRAKE	V-BRAKE
REAR BRAKE	V-BRAKE
BRAKE LEVERS	ALUMINIUM
SHIFTERS	SHIMANO RS36 REVOSHIFT
CRANKSET	WHEEL TOP
SPROCKETS	42T-34T-24T/170 mm
BOTTOM BRACKET	FP-B902
CHAIN	YBN S50
CASSETTE/FREEWHEEL	SHIMANO TOURNEY MF-TZ500
CASSETTE/FREEWHEEL RANGE	14-28T

WHEELS

FRONT HUB	GL-B01F-QR
REAR HUB	GL-B01R
RIMS	KROSS ALUMINIUM 19C
TIRES	WANDA P1255 2,1

COMPONENTS

HANDLEBAR	ALUMINIUM 660 mm 31,8
HANDLEBAR STEM	ALUMINIUM 75 mm/31,8/7°
SEAT POST	ALUMINIUM 27,2 x 300-350 mm
HEADSET	1-1/8"
SADDLE	YIBOTONG YBT-K610F046
GRIPS	HERRMANS
PEDALS	FP-804

GEOMETRY

SIZE	XS	S	M	L
FS - FRAME SIZE*	14	17	19	21
ST - SEAT TUBE LENGTH**	360	440	480	530
TT - TOP TUBE LENGTH**	550	570	585	600
HT - HEAD TUBE LENGTH**	120	120	135	150
SA - SEAT TUBE ANGLE***	73	73	73	73
HA - HEAD TUBE ANGLE***	71	71	71	71
CS - CHAINSTAY LENGTH**	430	430	430	430
WB - WHEELBASE**	1030	1050	1066	1081
REACH**	373	393	404	415
STACK**	579	579	593	607
BB DROP**	35	35	35	35

* dimension in inches, ** dimension in mm, *** dimension in degrees

HEXAGON



SKU	SIZE	COLOUR	FINISH
KRHEZZ26X14M004040	XS	black-red-gray	gloss
KRHEZZ26X17M004041	S	black-red-gray	gloss
KRHEZZ26X19M004042	M	black-red-gray	gloss
KRHEZZ26X14M004043	XS	graphite-lime-white	mat
KRHEZZ26X17M004044	S	graphite-lime-white	mat
KRHEZZ26X19M004045	M	graphite-lime-white	mat

GEAR RATIO 3 x 6

WHEEL DIAMETER 26"

COLOUR VARIANTS



FRAME

FRAME	ALUMINIUM PERFORMANCE
FORK	KROSS
FORK TRAVEL	80 mm
SIZES	XS(14"), S(17"), M(19")

DRIVETRAIN

FRONT DERAILLEUR	SHIMANO TOURNEY TZ500
REAR DERAILLEUR	SHIMANO TOURNEY TY300
FRONT BRAKE	V-BRAKE
REAR BRAKE	V-BRAKE
BRAKE LEVERS	ALUMINIUM
SHIFTERS	SHIMANO TX30
CRANKSET	WHEEL TOP
SPROCKETS	42T-34T-24T/170 mm
BOTTOM BRACKET	FP-B902
CHAIN	YBN S50
CASSETTE/FREEWHEEL	SHIMANO TOURNEY MF-TZ500
CASSETTE/FREEWHEEL RANGE	14-28T

WHEELS

FRONT HUB	GL-B01F
REAR HUB	GL-B01R
RIMS	KROSS ALUMINIUM 19C
TIRES	WANDA P1255 2,1

COMPONENTS

HANDLEBAR	STEEL 640 mm 25.4
HANDLEBAR STEM	ALUMINIUM 70 mm/25.4/7°
SEAT POST	ALUMINIUM 27,2 x 300-350 mm
HEADSET	FP-H863 O1-1/8"
SADDLE	YIBOTONG YBT-K610F046
GRIPS	HERRMANS
PEDALS	FP-804

GEOMETRY

SIZE	XS	S	M
FS - FRAME SIZE*	14	17	19
ST - SEAT TUBE LENGTH**	360	440	480
TT - TOP TUBE LENGTH**	550	570	585
HT - HEAD TUBE LENGTH**	120	120	135
SA - SEAT TUBE ANGLE***	73	73	73
HA - HEAD TUBE ANGLE***	71	71	71
CS - CHAINSTAY LENGTH**	430	430	430
WB - WHEELBASE**	1030	1050	1066
REACH**	373	393	404
STACK**	579	579	593
BB DROP**	35	35	35

* dimension in inches, ** dimension in mm, *** dimension in degrees

HEXAGON



SKU	SIZE	COLOUR	FINISH
KRHEZZ26X14M004615	XS	black-red-gray	gloss
KRHEZZ26X17M004616	S	black-red-gray	gloss
KRHEZZ26X19M004617	M	black-red-gray	gloss
KRHEZZ26X14M004618	XS	graphite-lime-white	mat

GEAR RATIO 3 x 6

WHEEL DIAMETER 26"

COLOUR VARIANTS



FRAME

FRAME	ALUMINIUM PERFORMANCE
FORK	KROSS
FORK TRAVEL	80 mm
SIZES	XS(14"), S(17"), M(19")

DRIVETRAIN

FRONT DERAILLEUR	SHIMANO TOURNEY TZ500
REAR DERAILLEUR	SHIMANO TOURNEY TY300
FRONT BRAKE	V-BRAKE
REAR BRAKE	V-BRAKE
BRAKE LEVERS	ALUMINIUM
SHIFTERS	SHIMANO TX30
CRANKSET	WHEEL TOP
SPROCKETS	42T-34T-24T/170 mm
BOTTOM BRACKET	FP-B902
CHAIN	YBN S50
CASSETTE/FREEWHEEL	SUNRACE MFM2A.7D
CASSETTE/FREEWHEEL RANGE	14-28T

WHEELS

FRONT HUB	GL-B01F
REAR HUB	GL-B01R
RIMS	KROSS ALUMINIUM 19C
TIRES	WANDA P1255 2,1

COMPONENTS

HANDLEBAR	STEEL 640 mm 25.4
HANDLEBAR STEM	ALUMINIUM 70 mm/25.4/7°
SEAT POST	ALUMINIUM 27,2 x 300-350 mm
HEADSET	1-1/8"
SADDLE	YIBOTONG YBT-K610F046
GRIPS	KRATON
PEDALS	FP-804

GEOMETRY

SIZE	XS	S	M
FS - FRAME SIZE*	14	17	19
ST - SEAT TUBE LENGTH**	360	440	480
TT - TOP TUBE LENGTH**	550	570	585
HT - HEAD TUBE LENGTH**	120	120	135
SA - SEAT TUBE ANGLE***	73	73	73
HA - HEAD TUBE ANGLE***	71	71	71
CS - CHAINSTAY LENGTH**	430	430	430
WB - WHEELBASE**	1030	1050	1066
REACH**	373	393	404
STACK**	579	579	593
BB DROP**	35	35	35

* dimension in inches, ** dimension in mm, *** dimension in degrees

LEA 5.0

NEW



SKU	SIZE	COLOUR	FINISH
KRLESZ27X14W006942	DXS/27,5"	gray	gloss
KRLESZ27X15W006944	DS/27,5"	gray	gloss
KRLESZ27X17W006946	DM/27,5"	gray	gloss
KRLESZ29X17W006948	DM/29"	gray	gloss
KRLESZ29X18W006950	DL/29"	gray	gloss
KRLESZ27X14W007660	DXS/27,5"	dark blue	gloss
KRLESZ27X15W007661	DS/27,5"	dark blue	gloss
KRLESZ27X17W007662	DM/27,5"	dark blue	gloss
KRLESZ29X17W007663	DM/29"	dark blue	gloss
KRLESZ29X18W007664	DL/29"	dark blue	gloss

GEAR RATIO 2 x 9
WHEEL DIAMETER 27,5"/29"
COLOUR VARIANTS



FRAME

FRAME	ALUMINIUM
FORK	SR SUNTOUR XCM RL
FORK TRAVEL	100 mm
SIZES	DXS(14"), DS(15"), DM(17"), DL(18")

DRIVETRAIN

FRONT DERAILLEUR	SHIMANO CUES U 4000
REAR DERAILLEUR	SIMANO CUES RD U3020
FRONT BRAKE	SHIMANO MT200
REAR BRAKE	SHIMANO MT200
BRAKE LEVERS	SHIMANO MT200
BRAKE DISCS	DISC (160 mm)
SHIFTERS	SHIMANO CUES U4000
CRANKSET	SHIMANO FC-U4000 CUES
SPROCKETS	36T-22T/170 mm
BOTTOM BRACKET	SHIMANO BSA BB-UN101
CHAIN	SHIMANO LG500
CASSETTE/FREEWHEEL	SHIMANO CUES LG300
CASSETTE/FREEWHEEL RANGE	11-36T

WHEELS

FRONT HUB	GL-B43F-DS
REAR HUB	GL-B43R-DS
RIMS	KROSS ALUMINIUM 19C
TIRES	WANDA MIKE BEAR 2,25

COMPONENTS

HANDLEBAR	ALUMINIUM 680 mm 31.8
HANDLEBAR STEM	ALUMINIUM 75 mm/31,8/7°
SEAT POST	ALUMINIUM 30,9 x 300 mm
HEADSET	FP-H863 O1-1/8"
SADDLE	YIBOTONG YBT-K610F046
GRIPS	PROPALM SCALE
PEDALS	FP-917N

GEOMETRY

SIZE	DXS/27,5"	DS/27,5"	DM/27,5"	DM/29"	DL/29"
FS - FRAME SIZE*	14	15	17	17	18
ST - SEAT TUBE LENGTH**	355	380	420	420	460
TT - TOP TUBE LENGTH**	524	552	580	590	607
HT - HEAD TUBE LENGTH**	100	110	120	115	120
SA - SEAT TUBE ANGLE***	74	73,5	73,5	73,5	73,5
HA - HEAD TUBE ANGLE***	68	68	68	68	68
CS - CHAINSTAY LENGTH**	435	435	435	450	450
WB - WHEELBASE**	355	380	405	410	425
REACH**	591	600	609	628	633
STACK**	1051	1080	1108	1131	1148
BB DROP**	50	50	50	60	60

* dimension in inches, ** dimension in mm, *** dimension in degrees

LEA 4.0 EQ

NEW



SKU	SIZE	COLOUR	FINISH
KRLE4E27X15W006934	DS/27,5"	gold pink	mat
KRLE4E27X17W006936	DM/27,5"	gold pink	mat
KRLE4E29X17W006938	DM/29"	gold pink	mat
KRLE4E29X18W006940	DL/29"	gold pink	mat
KRLE4E27X15W007656	DS/27,5"	grey blue	mat
KRLE4E27X15W007657	DM/27,5"	grey blue	mat
KRLE4E29X15W007658	DM/29"	grey blue	mat
KRLE4E29X15W007659	DL/29"	grey blue	mat

GEAR RATIO 2 x 8
WHEEL DIAMETER 27,5"/29"
COLOUR VARIANTS



FRAME

FRAME	ALUMINIUM
FORK	SR SUNTOUR NVX
FORK TRAVEL	100 mm
SIZES	DS(15"), DM(17"), DL(18")

DRIVETRAIN

FRONT DERAILLEUR	SHIMANO ALTUS M315
REAR DERAILLEUR	SHIMANO ACERA M360
FRONT BRAKE	SHIMANO MT200
REAR BRAKE	SHIMANO MT200
BRAKE LEVERS	SHIMANO MT200
BRAKE DISCS	POWER RT600 160 6B
SHIFTERS	SHIMANO M315
CRANKSET	WHEELTOP TM-CY10
SPROCKETS	36T-22T/170 mm
BOTTOM BRACKET	FP-B902
CHAIN	YBN S8
CASSETTE/FREEWHEEL	SHIMANO ACERA HG41
CASSETTE/FREEWHEEL RANGE	11-34T

WHEELS

FRONT HUB	GULI GL-B43F
REAR HUB	GULI GL-B43R
RIMS	KROSS ALUMINIUM 584 x 25
TIRES	KROSS P1255 2,1"

COMPONENTS

HANDLEBAR	ALUMINIUM 680 mm 31,8
HANDLEBAR STEM	ALUMINIUM 75 mm/31,8/7°
SEAT POST	ALUMINIUM 30,9 x 300 mm
HEADSET	FP-H863 O1-1/8"
SADDLE	K-SAN 810
GRIPS	PROPALM HANDY
CARRIER	STANDWELL ALLOY CARRY MORE SYSTEM
FRONT LIGHT	BUHEL AHEAD 35
REAR LIGHT	AXA JUNO
MUDGUARDS	PLASTIC
KICK STAND	REAR MARABOU II

GEOMETRY

SIZE	DS/27,5"	DM/27,5"	DM/29"	DL/29"
FS - FRAME SIZE*	15	17	17	18
ST - SEAT TUBE LENGTH**	380	420	420	460
TT - TOP TUBE LENGTH**	552	580	590	607
HT - HEAD TUBE LENGTH**	110	120	115	120
SA - SEAT TUBE ANGLE***	73,5	73,5	73,5	73,5
HA - HEAD TUBE ANGLE***	68	68	68	68
CS - CHAINSTAY LENGTH**	435	435	450	450
WB - WHEELBASE**	380	405	410	425
REACH**	600	609	628	633
STACK**	1080	1108	1131	1148
BB DROP**	50	50	60	60

* dimension in inches, ** dimension in mm, *** dimension in degrees

LEA 4.0

NEW



SKU	SIZE	COLOUR	FINISH
KRLE4Z27X14W007646	DXS/27,5"	blue	gloss
KRLE4Z27X14W007647	DS/27,5"	blue	gloss
KRLE4Z27X14W007648	DM/27,5"	blue	gloss
KRLE4Z29X14W007652	DM/29"	blue	gloss
KRLE4Z29X14W007653	DL/29"	blue	gloss
KRLE4Z27X14W007649	DXS/27,5"	pearl white	gloss
KRLE4Z27X14W007650	DS/27,5"	pearl white	gloss
KRLE4Z27X14W007651	DM/27,5"	pearl white	gloss
KRLE4Z29X14W007654	DM/29"	pearl white	gloss
KRLE4Z29X14W007655	DL/29"	pearl white	gloss

GEAR RATIO 2 x 8
WHEEL DIAMETER 27,5"/29"
COLOUR VARIANTS



FRAME

FRAME	ALUMINIUM
FORK	SR SUNTOUR NVX
FORK TRAVEL	100 mm
SIZES	DXS(14"), DXS(15"), DM(17")

DRIVETRAIN

FRONT DERAILLEUR	SHIMANO ALTUS M315
REAR DERAILLEUR	SHIMANO ACERA M360
FRONT BRAKE	SHIMANO MT200
REAR BRAKE	SHIMANO MT200
BRAKE LEVERS	SHIMANO MT200
BRAKE DISCS	DISC (160 mm)
SHIFTERS	SHIMANO M315
CRANKSET	WHEELTOP TM-CY10
SPROCKETS	36T-22T/170 mm
BOTTOM BRACKET	FP-B902
CHAIN	YBN S8
CASSETTE/FREEWHEEL	SHIMANO ACERA HG41
CASSETTE/FREEWHEEL RANGE	11-34T

WHEELS

FRONT HUB	GULI GL-B43F
REAR HUB	GULI GL-B43R
RIMS	KROSS ALUMINIUM 19C
TIRES	WANDA MIKE BEAR 2,25

COMPONENTS

HANDLEBAR	ALUMINIUM 680 mm 31.8
HANDLEBAR STEM	ALUMINIUM 75 mm/31,8/7°
SEAT POST	ALUMINIUM 30,9 x 300 mm
HEADSET	FP-H863 O1-1/8"
SADDLE	YIBOTONG YBT-K610F046
GRIPS	PROPALM HANDY
PEDALS	FP-804

GEOMETRY

SIZE	DXS/27,5"	DS/27,5"	DM/27,5"	DM/29"	DM/29"
FS - FRAME SIZE*	14	15	17	17	17
ST - SEAT TUBE LENGTH**	355	380	420	420	420
TT - TOP TUBE LENGTH**	524	552	580	590	590
HT - HEAD TUBE LENGTH**	100	110	120	115	115
SA - SEAT TUBE ANGLE***	74	73,5	73,5	73,5	73,5
HA - HEAD TUBE ANGLE***	68	68	68	68	68
CS - CHAINSTAY LENGTH**	435	435	435	450	450
WB - WHEELBASE**	355	380	405	410	410
REACH**	591	600	609	628	628
STACK**	1051	1080	1108	1131	1131
BB DROP**	50	50	50	60	60

* dimension in inches, ** dimension in mm, *** dimension in degrees

LEA 3.0

NEW



SKU	SIZE	COLOUR	FINISH
KRLE3Z27X14W007636	DXS/27,5"	pink	gloss
KRLE3Z27X15W007637	DS/27,5"	pink	gloss
KRLE3Z27X17W007638	DM/27,5"	pink	gloss
KRLE3Z29X17W007642	DM/29"	pink	gloss
KRLE3Z29X18W007643	DL/29"	pink	gloss
KRLE3Z27X14W007639	DXS/27,5"	black	gloss
KRLE3Z27X15W007640	DS/27,5"	black	gloss
KRLE3Z27X17W007641	DM/27,5"	black	gloss
KRLE3Z29X17W007644	DM/29"	black	gloss
KRLE3Z29X18W007645	DL/29"	black	gloss

GEAR RATIO 2 x 8
WHEEL DIAMETER 27,5"/29"
COLOUR VARIANTS



FRAME

FRAME	ALUMINIUM
FORK	KROSS
FORK TRAVEL	100 mm
SIZES	DXXS(14"), DXS(15"), DM(17"), DL(18")

DRIVETRAIN

FRONT DERAILLEUR	SHIMANO ALTUS M315
REAR DERAILLEUR	SHIMANO ACERA M360
FRONT BRAKE	MECHANICAL DISC
REAR BRAKE	MECHANICAL DISC
BRAKE LEVERS	ALUMINIUM
BRAKE DISCS	DISC (160 mm)
SHIFTERS	SHIMANO M315
CRANKSET	WHEELTOP TM-CY10
SPROCKETS	36T-22T/170 mm
BOTTOM BRACKET	FP-B902
CHAIN	YBN S8
CASSETTE/FREEWHEEL	SHIMANO ACERA HG41
CASSETTE/FREEWHEEL RANGE	11-34T

WHEELS

FRONT HUB	GULI GL-B43F
REAR HUB	GULI GL-B43R
RIMS	KROSS ALUMINIUM 19C
TIRES	KROSS P1288 2,25"

COMPONENTS

HANDLEBAR	ALUMINIUM 660 mm 31,8
HANDLEBAR STEM	ALUMINIUM 75 mm/31,8/7°
SEAT POST	ALUMINIUM 30,9 x 300 mm
HEADSET	FP-H863 O1-1/8"
SADDLE	YIBOTONG YBT-810NP003
GRIPS	PROPALM HANDY
PEDALS	FP-917N

GEOMETRY

SIZE	DXS/27,5"	DS/27,5"	DM/27,5"	DM/29"	DL/29"
FS - FRAME SIZE*	14	15	17	17	18
ST - SEAT TUBE LENGTH**	355	380	420	420	460
TT - TOP TUBE LENGTH**	524	552	580	590	607
HT - HEAD TUBE LENGTH**	100	110	120	115	120
SA - SEAT TUBE ANGLE***	74	73,5	73,5	73,5	73,5
HA - HEAD TUBE ANGLE***	68	68	68	68	68
CS - CHAINSTAY LENGTH**	435	435	435	450	450
WB - WHEELBASE**	355	380	405	410	425
REACH**	591	600	609	628	633
STACK**	1051	1080	1108	1131	1148
BB DROP**	50	50	50	60	60

* dimension in inches, ** dimension in mm, *** dimension in degrees

LEA 2.0 EQ

NEW



SKU	SIZE	COLOUR	FINISH
KRLE2E27X15W006906	DS/27,5"	orange-blue	gloss
KRLE2E27X17W006908	DM/27,5"	orange-blue	gloss
KRLE2E29X17W006910	DM/29"	orange-blue	gloss
KRLE2E29X18W006912	DL/29"	orange-blue	gloss
KRLE2E27X15W006907	DS/27,5"	purple	gloss
KRLE2E27X17W006909	DM/27,5"	purple	gloss
KRLE2E29X17W006911	DM/29"	purple	gloss
KRLE2E29X18W006913	DL/29"	purple	gloss

GEAR RATIO 3 x 7

WHEEL DIAMETER 27,5"/29"

COLOUR VARIANTS



FRAME

FRAME	ALUMINIUM
FORK	ZOOM FORGO 565 AMS
FORK TRAVEL	100 mm
SIZES	DS(15"), DM(17"), DL(18")

DRIVETRAIN

FRONT DERAILLEUR	SHIMANO TOURNEY TY300
REAR DERAILLEUR	SHIMANO ALTUS M310
FRONT BRAKE	MECHANICAL DISC
REAR BRAKE	MECHANICAL DISC
BRAKE LEVERS	SHIMANO TOURNEY ST-EF41
BRAKE DISCS	DISC (160MM)
SHIFTERS	SHIMANO TOURNEY ST-EF41
CRANKSET	WHEEL TOP TCSH4-CFPG
SPROCKETS	42T-34T-24T/170 mm
BOTTOM BRACKET	FP-B902
CHAIN	KMC HV500
CASSETTE/FREEWHEEL	SHIMANO TOURNEY MF-TZ500
CASSETTE/FREEWHEEL RANGE	14-28T

WHEELS

FRONT HUB	GULI GL-B01F
REAR HUB	GULI GL-B10R
RIMS	KROSS ALUMINIUM 584 x 19
TIRES	WANDA P1255 27,5 x 2,1

COMPONENTS

HANDLEBAR	ALUMINIUM 660 mm 31,8
HANDLEBAR STEM	ALUMINIUM 75 mm/31,8/7°
SEAT POST	ALUMINIUM 30,9 x 300 mm
HEADSET	FP-H863 O1-1/8"
SADDLE	K-SAN 810
GRIPS	PROPALM HANDY
CARRIER	STANDWELL ALLOY CARRY MORE SYSTEM
FRONT LIGHT	BUHEL AHEAD 35
REAR LIGHT	AXA JUNO
MUDGUARDS	PLASTIC
KICK STAND	REAR MARABOU II

GEOMETRY

SIZE	DS/27,5"	DM/27,5"	DM/29"	DL/29"
FS - FRAME SIZE*	15	17	17	18
ST - SEAT TUBE LENGTH**	380	420	420	460
TT - TOP TUBE LENGTH**	552	580	590	607
HT - HEAD TUBE LENGTH**	110	120	115	120
SA - SEAT TUBE ANGLE***	73,5	73,5	73,5	73,5
HA - HEAD TUBE ANGLE***	68	68	68	68
CS - CHAINSTAY LENGTH**	435	435	450	450
WB - WHEELBASE**	380	405	410	425
REACH**	600	609	628	633
STACK**	1080	1108	1131	1148
BB DROP**	50	50	60	60

* dimension in inches, ** dimension in mm, *** dimension in degrees

LEA 2.0

NEW



SKU	SIZE	COLOUR	FINISH
KRLE2Z27X14W007633	DXS/27,5"	peach	gloss
KRLE2Z27X14W007634	DS/27,5"	peach	gloss
KRLE2Z27X14W007635	DM/27,5"	peach	gloss
KRLE2Z29X17W007665	DM/29"	peach	gloss
KRLE2Z29X17W007665	DL/29"	peach	gloss
KRLE2Z27X15W006899	DS/27,5"	gray	gloss
KRLE2Z27X17W006901	DM/27,5"	gray	gloss
KRLE2Z29X17W006903	DM/29"	gray	gloss
KRLE2Z29X18W006905	DL/29"	gray	gloss

GEAR RATIO 3 x 7
WHEEL DIAMETER 27,5"/29"
COLOUR VARIANTS



FRAME

FRAME	ALUMINIUM
FORK	KROSS
FORK TRAVEL	100 mm
SIZES	DXS(14"), DS(15"), DM(17"), DL(18")

DRIVETRAIN

FRONT DERAILLEUR	SHIMANO TOURNEY TY300
REAR DERAILLEUR	SHIMANO ALTUS M310
FRONT BRAKE	MECHANICAL DISC
REAR BRAKE	MECHANICAL DISC
BRAKE LEVERS	SHIMANO TOURNEY ST-EF41
BRAKE DISCS	DISC (160 mm)
SHIFTERS	SHIMANO TOURNEY ST-EF41
CRANKSET	WHEEL TOP TCSH4-CFPG
SPROCKETS	42T-34T-24T/170 mm
BOTTOM BRACKET	FP-B902
CHAIN	KMC HV500
CASSETTE/FREEWHEEL	SHIMANO TOURNEY MF-TZ500
CASSETTE/FREEWHEEL RANGE	14-28T

WHEELS

FRONT HUB	GL-B01F-QR
REAR HUB	GL-B01R-QR
RIMS	KROSS ALUMINIUM 19C
TIRES	KROSS P1288 29/27,5 x 2,25

COMPONENTS

HANDLEBAR	ALUMINIUM 660 mm 31,8
HANDLEBAR STEM	ALUMINIUM 75 mm/31,8/7°
SEAT POST	ALUMINIUM 30,9 x 300 mm
HEADSET	FP-H863 O1-1/8"
SADDLE	YIBOTONG YBT-810NP003
GRIPS	PROPALM HANDY
PEDALS	FP-804

GEOMETRY

SIZE	DXS/27,5"	DS/27,5"	DM/27,5"	DM/29"	DL/29"
FS - FRAME SIZE*	14	15	17	17	18
ST - SEAT TUBE LENGTH**	355	380	420	420	460
TT - TOP TUBE LENGTH**	524	552	580	590	607
HT - HEAD TUBE LENGTH**	100	110	120	115	120
SA - SEAT TUBE ANGLE***	74	73,5	73,5	73,5	73,5
HA - HEAD TUBE ANGLE***	68	68	68	68	68
CS - CHAINSTAY LENGTH**	435	435	435	450	450
WB - WHEELBASE**	355	380	405	410	425
REACH**	591	600	609	628	633
STACK**	1051	1080	1108	1131	1148
BB DROP**	50	50	50	60	60

* dimension in inches, ** dimension in mm, *** dimension in degrees

LEA 1.0

NEW



SKU	SIZE	COLOUR	FINISH
KRLE1Z26X13W006888	DXXS	blue	gloss
KRLE1Z26X15W006890	DXS	blue	gloss
KRLE1Z26X17W006892	DS	blue	gloss
KRLE1Z26X19W006894	DM	blue	gloss
KRLE1Z26X13W007629	DXXS	pink	mat
KRLE1Z26X13W007630	DXS	pink	mat
KRLE1Z26X13W007631	DS	pink	mat
KRLE1Z26X13W007632	DM	pink	mat

GEAR RATIO 3 x 7

WHEEL DIAMETER 26"

COLOUR VARIANTS



FRAME

FRAME	ALUMINIUM
FORK	KROSS
FORK TRAVEL	80 mm
SIZES	DXXS(14"), DXS(15"), DS(17"), DM(19")

DRIVETRAIN

FRONT DERAILLEUR	SHIMANO TOURNEY TZ500
REAR DERAILLEUR	SHIMANO TOURNEY TY300
FRONT BRAKE	V-BRAKE
REAR BRAKE	V-BRAKE
BRAKE LEVERS	ALUMINIUM
SHIFTERS	SHIMANO TOURNEY REVOSHIFT RS36
CRANKSET	WHEEL TOP TCSH4-CFPG
SPROCKETS	42T-34T-24T/170 mm
BOTTOM BRACKET	FP-B902
CHAIN	YBN S50
CASSETTE/FREEWHEEL	SHIMANO TOURNEY MF-TZ500
CASSETTE/FREEWHEEL RANGE	14-28T

WHEELS

FRONT HUB	GL-B01F-QR
REAR HUB	GL-B01R
RIMS	KROSS ALUMINIUM 19C
TIRES	WANDA P1255 2,1

COMPONENTS

HANDLEBAR	ALUMINIUM 640 mm 31,8
HANDLEBAR STEM	ALUMINIUM 60 mm/31,8/7°
SEAT POST	ALUMINIUM 27,2 x 350 mm
HEADSET	FP-H863 O1-1/8"
SADDLE	YIBOTONG YBT-810NPO03
GRIPS	HERMANS 89A
PEDALS	FP-804

GEOMETRY

SIZE	DXXS	DXS	DS	DM
FS - FRAME SIZE*	13	15	17	19
ST - SEAT TUBE LENGTH**	330	381	432	483
TT - TOP TUBE LENGTH**	530	545	560	575
HT - HEAD TUBE LENGTH**	115	125	135	145
SA - SEAT TUBE ANGLE***	72,5	72,5	72,5	72,5
HA - HEAD TUBE ANGLE***	70	70	70	70
CS - CHAINSTAY LENGTH**	430	430	430	430
WB - WHEELBASE**	1015	1031	1046	1062
REACH**	349	361	373	385
STACK**	574	584	593	602
BB DROP**	35	35	35	35

* dimension in inches, ** dimension in mm, *** dimension in degrees

LEA 8.0



SKU	SIZE	COLOUR	FINISH
KRLE8Z27X16W004195	DXS/27,5"	black-pink-blue	mat
KRLE8Z29X17W004196	DS/29"	black-pink-blue	mat
KRLE8Z29X19W004197	DM/29"	black-pink-blue	mat

GEAR RATIO 3 x 9
WHEEL DIAMETER 27,5"/29"
COLOUR VARIANTS



FRAME

FRAME	ALUMINIUM PERFORMANCE WOMEN GE
FORK	SR SUNTOUR XCR 32 RLR AIR
FORK TRAVEL	100 mm
SIZES	DXXS(14"), DXS(16"), DS(17"), DM(19")

DRIVETRAIN

FRONT DERAILLEUR	SHIMANO ALIVIO M4000
REAR DERAILLEUR	SHIMANO DEORE M592
FRONT BRAKE	SHIMANO MT200
REAR BRAKE	SHIMANO MT200
BRAKE LEVERS	SHIMANO MT200
BRAKE DISCS	DISC (160 mm)
SHIFTERS	SHIMANO ALIVIO M4000
CRANKSET	ALUMINIUM
SPROCKETS	40T-30T-22T/175 mm
BOTTOM BRACKET	FP-B902
CHAIN	SHIMANO HG53
CASSETTE/FREEWHEEL	SHIMANO ALIVIO HG400
CASSETTE/FREEWHEEL RANGE	11-34T

WHEELS

FRONT HUB	GL-B43F-DS
REAR HUB	GL-B43R-DS
RIMS	KROSS ALUMINIUM 19C
TIRES	WANDA P1255 2,1

COMPONENTS

HANDLEBAR	ALUMINIUM 660 mm 31,8
HANDLEBAR STEM	ALUMINIUM 70 mm/31,8/7°
SEAT POST	ALUMINIUM 27,2 x 300 mm
HEADSET	FP-H863 O1-1/8"
SADDLE	SELLE ITALIA X-BASE BOOST
GRIPS	KROSS HANDY
PEDALS	FP-917N

GEOMETRY

SIZE	DXS/27,5"	DS/29"	DM/29"
FS - FRAME SIZE*	16	17	19
ST - SEAT TUBE LENGTH**	394	432	470
TT - TOP TUBE LENGTH**	567	581	593
HT - HEAD TUBE LENGTH**	120	120	120
SA - SEAT TUBE ANGLE***	73	73	73
HA - HEAD TUBE ANGLE***	69	69	69
CS - CHAINSTAY LENGTH**	435	450	450
WB - WHEELBASE**	1079	1127	1124
REACH**	385	394	406
STACK**	595	612	612
BB DROP**	35	35	35

* dimension in inches, ** dimension in mm, *** dimension in degrees

LEA 6.0



SKU	SIZE	COLOUR	FINISH
KRLE6Z27X14W005496	DXXS/27,5"	black-pink	mat
KRLE6Z27X16W005497	DXS/27,5"	black-pink	mat
KRLE6Z29X17W005498	DS/29"	black-pink	mat

GEAR RATIO 3 x 8
WHEEL DIAMETER 27,5"/29"
COLOUR VARIANTS



FRAME

FRAME	ALUMINIUM PERFORMANCE WOMEN GE
FORK	SR SUNTOUR XCT30 HLO
FORK TRAVEL	80 mm
SIZES	DXXS(14"), DXS(16"), DS(17")

DRIVETRAIN

FRONT DERAILLEUR	MICROSHIFT MEZZO FD-M20
REAR DERAILLEUR	MICROSHIFT MEZZO M36L
FRONT BRAKE	POWER BH-M960
REAR BRAKE	POWER BH-M960
BRAKE LEVERS	POWER BH-M960
BRAKE DISCS	DISC (160 mm)
SHIFTERS	MICROSHIFT MEZZO
CRANKSET	SUNTOUR XCC
SPROCKETS	42T-34T-24T/175 mm
BOTTOM BRACKET	FP-B902
CHAIN	YBN S8
CASSETTE/FREEWHEEL	SHIMANO TURNEY HG200
CASSETTE/FREEWHEEL RANGE	12-32T

WHEELS

FRONT HUB	GL-B43F-DS
REAR HUB	GL-B43R-DS
RIMS	KROSS ALUMINIUM 584 x 19
TIRES	WANDA P1255 27,5 x 2,1

COMPONENTS

HANDLEBAR	ALUMINIUM 660 mm 31,8
HANDLEBAR STEM	ALUMINIUM 70 mm/31,8/7°
SEAT POST	ALUMINIUM 27,2 x 300 mm
HEADSET	FP-H863 O1-1/8"
SADDLE	SELLE ITALIA X-BASE BOOST
GRIPS	KROSS HANDY
PEDALS	FP-917N

GEOMETRY

SIZE	DXXS/27,5"	DXS/27,5"	DS/29"
FS - FRAME SIZE*	14	16	17
ST - SEAT TUBE LENGTH**	343	394	432
TT - TOP TUBE LENGTH**	555	567	581
HT - HEAD TUBE LENGTH**	115	120	120
SA - SEAT TUBE ANGLE***	73	73	73
HA - HEAD TUBE ANGLE***	69	69	69
CS - CHAINSTAY LENGTH**	435	435	450
WB - WHEELBASE**	1067	1079	1127
REACH**	375	385	394
STACK**	590	595	612
BB DROP**	35	35	35

* dimension in inches, ** dimension in mm, *** dimension in degrees

LEA 6.0



SKU	SIZE	COLOUR	FINISH
KRLE6Z27X14W001917	DXXS/27,5"	black-pink	mat
KRLE6Z29X17W001919	DS/29"	black-pink	mat
KRLE6Z29X19W001920	DM/29"	black-pink	mat
KRLE6Z27X16W006349	DXS/27,5"	orange-blue	mat
KRLE6Z29X17W006350	DS/29"	orange-blue	mat

GEAR RATIO 3 x 8
WHEEL DIAMETER 27,5"/29"
COLOUR VARIANTS

FRAME

FRAME	ALUMINIUM PERFORMANCE WOMEN GE
FORK	SR SUNTOUR XCT30 HLO
FORK TRAVEL	80 mm
SIZES	DXXS(14"), DXS(16"), DS(17"), DM(19")

DRIVETRAIN

FRONT DERAILLEUR	SHIMANO TOURNEY TY700
REAR DERAILLEUR	SHIMANO ACERA M360
FRONT BRAKE	SHIMANO ALTUS ST-EF505
REAR BRAKE	SHIMANO MT200
BRAKE LEVERS	SHIMANO EF505
BRAKE DISCS	DISC (160 mm)
SHIFTERS	SHIMANO EF505
CRANKSET	ALUMINIUM
SPROCKETS	42T-34T-24T/175 mm
BOTTOM BRACKET	FP-B902
CHAIN	YBN S8
CASSETTE/FREEWHEEL	SHIMANO HG200
CASSETTE/FREEWHEEL RANGE	12-32T

WHEELS

FRONT HUB	GL-B43F-DS
REAR HUB	GL-B43R-DS
RIMS	KROSS
TIRES	27,5"x2,1" ; 54-584

COMPONENTS

HANDLEBAR	ALUMINIUM 660 mm 31,8
HANDLEBAR STEM	ALUMINIUM 70 mm/31,8/7°
SEAT POST	ALUMINIUM 27,2 x 300 mm
HEADSET	FP-H863 O1-1/8"
SADDLE	SELLE ITALIA X-BASE BOOST
GRIPS	KROSS HANDY
PEDALS	FP-917N

GEOMETRY

SIZE	DXXS/27,5"	DXS/27,5"	DS/29"	DM/29"
FS - FRAME SIZE*	14	16	17	19
ST - SEAT TUBE LENGTH**	343	394	432	470
TT - TOP TUBE LENGTH**	555	567	581	593
HT - HEAD TUBE LENGTH**	115	120	120	120
SA - SEAT TUBE ANGLE***	73	73	73	73
HA - HEAD TUBE ANGLE***	69	69	69	69
CS - CHAINSTAY LENGTH**	435	435	450	450
WB - WHEELBASE**	1067	1079	1127	1124
REACH**	375	385	394	406
STACK**	590	595	612	612
BB DROP**	35	35	35	35

* dimension in inches, ** dimension in mm, *** dimension in degrees

LEA 5.0



SKU	SIZE	COLOUR	FINISH
KRLESZ27X14W006340	DXXS/27,5"	rose gold-turquoise	gloss
KRLESZ27X16W006341	DXS/27,5"	rose gold-turquoise	gloss
KRLESZ29X17W006342	DS/29"	rose gold-turquoise	gloss
KRLESZ29X19W006343	DM/29"	rose gold-turquoise	gloss
KRLESZ27X14W006344	DXXS/27,5"	turquoise-purple	mat
KRLESZ27X16W006345	DXS/27,5"	turquoise-purple	mat
KRLESZ29X17W006346	DS/29"	turquoise-purple	mat
KRLESZ29X19W006347	DM/29"	turquoise-purple	mat

GEAR RATIO 3 x 8

WHEEL DIAMETER 27,5"/29"

COLOUR VARIANTS



FRAME

FRAME	ALUMINIUM PERFORMANCE WOMEN GE
FORK	SR SUNTOUR XCE28
FORK TRAVEL	80 mm
SIZES	DXXS(14"), DXS(16"), DS(17"), DM(19")

DRIVETRAIN

FRONT DERAILLEUR	MICROSHIFT MEZZO FD-M30
REAR DERAILLEUR	MICROSHIFT MEZZO M36L
FRONT BRAKE	POWER BH-M960
REAR BRAKE	POWER BH-M960
BRAKE LEVERS	POWER BH-M960
BRAKE DISCS	DISC (160 mm)
SHIFTERS	POWER BH-M960
CRANKSET	PROWHEEL
SPROCKETS	42T-34T-24T/175 mm
BOTTOM BRACKET	FP-B902
CHAIN	YBN S8
CASSETTE/FREEWHEEL	SHIMANO TURNEY HG200
CASSETTE/FREEWHEEL RANGE	12-32T

WHEELS

FRONT HUB	GL-B43F-DS
REAR HUB	GL-B43R-DS
RIMS	KROSS ALUMINIUM 19C
TIRES	WANDA P1255 2,1

COMPONENTS

HANDLEBAR	ALUMINIUM 660 mm 31,8
HANDLEBAR STEM	ALUMINIUM 70 mm/31,8/7°
SEAT POST	ALUMINIUM 27,2 x 300 mm
HEADSET	FP-H863 O1-1/8"
SADDLE	YIBOTONG YBT-810NP003
GRIPS	KROSS HANDY
PEDALS	FP-917N

GEOMETRY

SIZE	DXXS/27,5"	DXS/27,5"	DS/29"	DM/29"
FS - FRAME SIZE*	14	16	17	19
ST - SEAT TUBE LENGTH**	343	394	432	470
TT - TOP TUBE LENGTH**	555	569	581	593
HT - HEAD TUBE LENGTH**	105	110	115	115
SA - SEAT TUBE ANGLE***	73	73	73	73
HA - HEAD TUBE ANGLE***	70	70	70	70
CS - CHAINSTAY LENGTH**	435	435	450	450
WB - WHEELBASE**	1037	1051	1101	1112
REACH**	375	387	394	406
STACK**	590	595	612	611
BB DROP**	35	35	35	35

* dimension in inches, ** dimension in mm, *** dimension in degrees

LEA 5.0



SKU	SIZE	COLOUR	FINISH
KRLE5Z27X16W006325	DXS/27,5"	rose gold-turquoise	gloss
KRLE5Z29X17W006326	DS/29"	rose gold-turquoise	gloss
KRLE5Z29X19W006327	DM/29"	rose gold-turquoise	gloss
KRLE5Z29X17W006330	DS/29"	turquoise-purple	mat
KRLE5Z29X19W006331	DM/29"	turquoise-purple	mat

GEAR RATIO 3 x 8

WHEEL DIAMETER 27,5"/29"

COLOUR VARIANTS

FRAME

FRAME	ALUMINIUM PERFORMANCE WOMEN GE
FORK	SR SUNTOUR XCE28
FORK TRAVEL	80 mm
SIZES	DXS(16"), DS(17"), DM(19")

DRIVETRAIN

FRONT DERAILLEUR	SHIMANO TOURNEY TY700
REAR DERAILLEUR	SHIMANO ACERA T3000
FRONT BRAKE	SHIMANO ALTUS ST-EF505
REAR BRAKE	SHIMANO MT200
BRAKE LEVERS	SHIMANO ALTUS ST-EF505
BRAKE DISCS	DISC (160 mm)
SHIFTERS	SHIMANO EF505
CRANKSET	ALUMINIUM
SPROCKETS	42T-34T-24T/175 mm
BOTTOM BRACKET	FP-B902
CHAIN	YBN S8
CASSETTE/FREEWHEEL	SHIMANO TURNEY HG200
CASSETTE/FREEWHEEL RANGE	12-32T

WHEELS

FRONT HUB	GL-B43F-DS
REAR HUB	GL-B43R-DS
RIMS	KROSS ALUMINIUM 19C
TIRES	WANDA P1255 2,1

COMPONENTS

HANDLEBAR	ALUMINIUM 660 mm 31,8
HANDLEBAR STEM	ALUMINIUM 70 mm/31,8/7°
SEAT POST	ALUMINIUM 27,2 x 300 mm
HEADSET	FP-H863 Q1-1/8"
SADDLE	YIBOTONG YBT-810NP003
GRIPS	KROSS HANDY
PEDALS	FP-917N

GEOMETRY

SIZE	DXS/27,5"	DS/29"	DM/29"
FS - FRAME SIZE*	16	17	19
ST - SEAT TUBE LENGTH**	394	432	470
TT - TOP TUBE LENGTH**	569	581	593
HT - HEAD TUBE LENGTH**	110	115	115
SA - SEAT TUBE ANGLE***	73	73	73
HA - HEAD TUBE ANGLE***	70	70	70
CS - CHAINSTAY LENGTH**	435	450	450
WB - WHEELBASE**	1051	1101	1112
REACH**	387	394	406
STACK**	595	612	611
BB DROP**	35	35	35

* dimension in inches, ** dimension in mm, *** dimension in degrees

LEA 3.0



SKU	SIZE	COLOUR	FINISH
KRLE3Z26X13W001332	DXXS/26"	purple-pink-orange	mat
KRLE3Z26X15W001333	DXS/26"	purple-pink-orange	mat
KRLE3Z27X15W001329	DXS/27,5"	purple-pink-orange	mat
KRLE3Z27X17W001330	DS/27,5"	purple-pink-orange	mat
KRLE3Z27X19W001331	DM/27,5"	purple-pink-orange	mat
KRLE3Z26X13W001337	DXXS/26"	white-purple	gloss
KRLE3Z26X15W001338	DXS/26"	white-purple	gloss
KRLE3Z27X15W001334	DXS/27,5"	white-purple	gloss
KRLE3Z27X17W001335	DS/27,5"	white-purple	gloss
KRLE3Z27X19W001336	DM/27,5"	white-purple	gloss

GEAR RATIO 3 x 7
WHEEL DIAMETER 26"/27,5"
COLOUR VARIANTS

FRAME

FRAME	ALUMINIUM PERFORMANCE WOMEN GE
FORK	KROSS
FORK TRAVEL	80 mm
SIZES	DXXS(13"), DXS(15"), DS(17"), DM(19")

DRIVETRAIN

FRONT DERAILLEUR	SHIMANO TOURNEY TY300
REAR DERAILLEUR	SHIMANO ALTUS M310
FRONT BRAKE	MECHANICAL DISC
REAR BRAKE	MECHANICAL DISC
BRAKE LEVERS	SHIMANO TOURNEY ST-EF41
BRAKE DISCS	DISC (160 mm)
SHIFTERS	SHIMANO TOURNEY ST-EF41
CRANKSET	WHEEL TOP
SPROCKETS	42T-34T-24T/170 mm
BOTTOM BRACKET	FP-B902
CHAIN	YBN S50
CASSETTE/FREEWHEEL	SHIMANO TOURNEY MF-TZ500
CASSETTE/FREEWHEEL RANGE	14-28T

WHEELS

FRONT HUB	GL-B10F-DS
REAR HUB	GL-B10R-DS
RIMS	KROSS ALUMINIUM 19C
TIRES	WANDA P1255 2,1

COMPONENTS

HANDLEBAR	ALUMINIUM 640 mm 31,8
HANDLEBAR STEM	ALUMINIUM 60 mm/31,8/7°
SEAT POST	ALUMINIUM 27,2 x 350 mm
HEADSET	FP-H863 O1-1/8"
SADDLE	YIBOTONG YBT-810NP003
GRIPS	KROSS HANDY
PEDALS	FP-917N

GEOMETRY

SIZE	DXXS/26"	DXS/26"	DXS/27,5"	DS/27,5"	DM/27,5"
FS - FRAME SIZE*	13	15	15	17	19
ST - SEAT TUBE LENGTH**	330	381	380	430	480
TT - TOP TUBE LENGTH**	530	545	560	570	580
HT - HEAD TUBE LENGTH**	115	125	125	135	145
SA - SEAT TUBE ANGLE***	72,5	72,5	73	72,5	72,5
HA - HEAD TUBE ANGLE***	70	70	70	70	70
CS - CHAINSTAY LENGTH**	430	430	435	435	435
WB - WHEELBASE**	1015	1031	1043	1048	1058
REACH**	349	361	374	375	382
STACK**	574	584	609	619	628
BB DROP**	35	35	35	35	35

* dimension in inches, ** dimension in mm, *** dimension in degrees

LEA 2.0



SKU	SIZE	COLOUR	FINISH
KRLE2Z26X13W001342	DXXS/26"	black-raspberry-purple	mat
KRLE2Z26X15W001343	DXS/26"	black-raspberry-purple	mat
KRLE2Z27X15W001339	DXS/27,5"	black-raspberry-purple	mat
KRLE2Z27X17W001340	DS/27,5"	black-raspberry-purple	mat
KRLE2Z27X19W001341	DM/27,5"	black-raspberry-purple	mat
KRLE2Z26X13W001347	DXXS/26"	silver-white-pink	mat
KRLE2Z26X15W001348	DXS/26"	silver-white-pink	mat
KRLE2Z27X15W001344	DXS/27,5"	silver-white-pink	mat

GEAR RATIO 3 x 7

WHEEL DIAMETER 26"/27,5"

COLOUR VARIANTS



FRAME

FRAME	ALUMINIUM PERFORMANCE WOMEN GE
FORK	KROSS
FORK TRAVEL	80 mm
SIZES	DXXS(14"), DXS(15"), DS(17"), DM(19")

DRIVETRAIN

FRONT DERAILLEUR	SHIMANO TOURNEY TY300
REAR DERAILLEUR	SHIMANO ALTUS M310
FRONT BRAKE	V-BRAKE
REAR BRAKE	V-BRAKE
BRAKE LEVERS	SHIMANO TOURNEY ST-EF41
SHIFTERS	SHIMANO TOURNEY ST-EF41
CRANKSET	WHEEL TOP
SPROCKETS	42T-34T-24T/170 mm
BOTTOM BRACKET	FP-B902
CHAIN	YBN S50
CASSETTE/FREEWHEEL	SHIMANO TOURNEY MF-TZ500
CASSETTE/FREEWHEEL RANGE	14-28T

WHEELS

FRONT HUB	GL-B01F-QR
REAR HUB	GL-B01R-QR
RIMS	KROSS ALUMINIUM 19C
TIRES	WANDA P1255 2,1

COMPONENTS

HANDLEBAR	ALUMINIUM 640 mm 31,8
HANDLEBAR STEM	ALUMINIUM 60 mm/31,8/7°
SEAT POST	ALUMINIUM 27,2 x 350 mm
HEADSET	FP-H863 O1-1/8"
SADDLE	YIBOTONG YBT-810NP003
GRIPS	KROSS HANDY
PEDALS	FP-804

GEOMETRY

SIZE	DXXS/26"	DXS/26"	DXS/27,5"	DS/27,5"	DM/27,5"
FS - FRAME SIZE*	13	15	15	17	19
ST - SEAT TUBE LENGTH**	330	381	380	430	480
TT - TOP TUBE LENGTH**	530	545	560	570	580
HT - HEAD TUBE LENGTH**	115	125	125	135	145
SA - SEAT TUBE ANGLE***	72,5	72,5	73	72,5	72,5
HA - HEAD TUBE ANGLE***	70	70	70	70	70
CS - CHAINSTAY LENGTH**	430	430	435	435	435
WB - WHEELBASE**	1015	1031	1043	1048	1058
REACH**	349	361	374	375	382
STACK**	574	584	609	619	628
BB DROP**	35	35	35	35	35

* dimension in inches, ** dimension in mm, *** dimension in degrees

LEA 1.0



SKU	SIZE	COLOUR	FINISH
KRLE1Z26X13W001353	DXXS	white-blue	gloss
KRLE1Z26X15W001354	DXS	white-blue	gloss
KRLE1Z26X17W001355	DS	white-blue	gloss
KRLE1Z26X19W001356	DM	white-blue	gloss
KRLE1Z26X13W001349	DXXS	black-raspberry-graphite	mat
KRLE1Z26X17W001351	DS	black-raspberry-graphite	mat

GEAR RATIO 3 x 7

WHEEL DIAMETER 26"

COLOUR VARIANTS



FRAME

FRAME	ALUMINIUM PERFORMANCE WOMEN GE
FORK	ZOOM FORGO565
FORK TRAVEL	80 mm
SIZES	DXXS(13"), DXS(15"), DS(17"), DM (19")

DRIVETRAIN

FRONT DERAILLEUR	SHIMANO TOURNEY TZ500
REAR DERAILLEUR	SHIMANO TOURNEY TY300
FRONT BRAKE	V-BRAKE
REAR BRAKE	V-BRAKE
BRAKE LEVERS	ALUMINIUM
SHIFTERS	SHIMANO RS36 REVOSHIFT
CRANKSET	WHEEL TOP
SPROCKETS	42T-34T-24T/170 mm
BOTTOM BRACKET	FP-B902
CHAIN	YBN S50
CASSETTE/FREEWHEEL	SHIMANO TOURNEY MF-TZ500
CASSETTE/FREEWHEEL RANGE	14-28T

WHEELS

FRONT HUB	GL-B01F-QR
REAR HUB	GL-B01R
RIMS	KROSS ALUMINIUM 559 x 19
TIRES	WANDA P1255 26 x 2,1

COMPONENTS

HANDLEBAR	ALUMINIUM 640 mm 31,8
HANDLEBAR STEM	ALUMINIUM 60 mm/31,8/7°
SEAT POST	ALUMINIUM 27,2 x 350 mm
HEADSET	FP-H863 O1-1/8"
SADDLE	YIBOTONG YBT-810NPO03
GRIPS	HERRMANS
PEDALS	FP-804

GEOMETRY

SIZE	DXXS	DXS	DS	DM
FS - FRAME SIZE*	13	15	17	19
ST - SEAT TUBE LENGTH**	330	381	432	483
TT - TOP TUBE LENGTH**	530	545	560	575
HT - HEAD TUBE LENGTH**	115	125	135	145
SA - SEAT TUBE ANGLE***	72,5	72,5	72,5	72,5
HA - HEAD TUBE ANGLE***	70	70	70	70
CS - CHAINSTAY LENGTH**	430	430	430	430
WB - WHEELBASE**	1015	1031	1046	1062
REACH**	349	361	373	385
STACK**	574	584	593	602
BB DROP**	35	35	35	35

* dimension in inches, ** dimension in mm, *** dimension in degrees

TREKKING BIKES

TRANS

Trans is the ideal choice for those seeking a comfortable, functional, and versatile bike for daily commutes, recreational rides, and longer touring adventures. Thanks to its versatility and practicality, Trans allows you to discover new places and enjoy riding on a wide various routes.

The new frames with a refreshed shape, design, and colour scheme, featuring internal cable routing and a water bottle mount, also available in the women's version, come equipped with disc brakes that provide not only comfort but also confidence in safe riding and braking.

Geometry: KROSS Trans has a comfortable geometry, ensuring comfort even during long rides and reducing the strain on the spine.

Functionality and practicality: KROSS Trans is equipped with practical utility features such as a rack, mudguards, and lighting.





TRANS 7.0

NEW



GEAR RATIO 2 x 10

WHEEL DIAMETER 28"

COLOUR VARIANTS



SKU	SIZE	COLOUR	FINISH
KRTR7Z28X21M006171	M	black-gray	gloss
KRTR7Z28X21M006172	L	black-gray	gloss
KRTR7Z28X19W006173	XL	black-gray	gloss

FRAME

FRAME	ALUMINIUM PERFORMANCE
FORK	SR SUNTOUR NEX HLO
FORK TRAVEL	63 mm
SIZES	M(19"), L(21"), XL(23")

DRIVETRAIN

FRONT DERAILLEUR	SIMANO CUES FD U4010
REAR DERAILLEUR	SIMANO CUES RD U6020
FRONT BRAKE	SHIMANO MT200
REAR BRAKE	SHIMANO MT200
BRAKE LEVERS	SHIMANO MT201
BRAKE DISCS	SHIMANO RT10 160 CL
SHIFTERS	SHIMANO CUES U6000
CRANKSET	SHIMANO FC-U4010 CUES
SPROCKETS	46T-30T/170 mm
BOTTOM BRACKET	SHIMANO BB-MT501
CHAIN	SHIMANO LG500
CASSETTE/FREEWHEEL	SHIMANO CUES LG400
CASSETTE/FREEWHEEL RANGE	11-39T

WHEELS

FRONT HUB	SHIMANO NEXUS DH-3D37
REAR HUB	SHIMANO TOURNEY TX505
RIMS	KROSS ALUMINIUM 622 x 25
TIRES	SCHWALBE SILENTO 28 x 1,6

COMPONENTS

HANDLEBAR	ALUMINIUM 640 mm 31,8
HANDLEBAR STEM	ALUMINIUM 110 mm/31,8 REG
SEAT POST	AMORTIZED 31,6 x 350 mm
HEADSET	FP-H813PL 1-1/8"
SADDLE	SELLE ROYAL LOOKIN RVS MOD M
GRIPS	PROPALM GRIPPEN
PEDALS	FP-910
CARRIER	STANDWELL ALUMINIUM 28" 25 kg
FRONT LIGHT	AXA ECHO DYNAMO/EBIKE
REAR LIGHT	AXA JUNO DYNAMO/EBIKE
MUDGUARDS	TUBUS TW. SZT. 28"
KICK STAND	CENTRAL

GEOMETRY

SIZE	M	L	XL
FS - FRAME SIZE*	19	21	23
ST - SEAT TUBE LENGTH**	480	530	580
TT - TOP TUBE LENGTH**	570	585	600
HT - HEAD TUBE LENGTH**	140	140	160
SA - SEAT TUBE ANGLE***	74	74	74
HA - HEAD TUBE ANGLE***	70	70	70
CS - CHAINSTAY LENGTH**	460	460	460
WB - WHEELBASE**	1094	1109	1125
REACH**	395	410	420
STACK**	610	610	629
BB DROP**	60	60	60

* dimension in inches, ** dimension in mm, *** dimension in degrees

TRANS 7.0

NEW



SKU	SIZE	COLOUR	FINISH
KRTR7Z28X17W006169	DM	turquoise-black	gloss
KRTR7Z28X19W006170	DL	turquoise-black	gloss

GEAR RATIO 2 x 10

WHEEL DIAMETER 28"

COLOUR VARIANTS



FRAME

FRAME	ALUMINIUM 6061
FORK	SR SUNTOUR NEX HLO
FORK TRAVEL	63 mm
SIZES	DM(17"), DL(19")

DRIVETRAIN

FRONT DERAILLEUR	SIMANO CUES FD U4010
REAR DERAILLEUR	SIMANO CUES RD U6020
FRONT BRAKE	SHIMANO MT200
REAR BRAKE	SHIMANO MT200
BRAKE LEVERS	SHIMANO MT201
BRAKE DISCS	SHIMANO RT10 160 CL
SHIFTERS	SHIMANO CUES U6000
CRANKSET	SHIMANO FC-U4010 CUES
SPROCKETS	46T-30T/170 mm
BOTTOM BRACKET	SHIMANO BB-MT501
CHAIN	SHIMANO LG500
CASSETTE/FREEWHEEL	SHIMANO CUES LG400
CASSETTE/FREEWHEEL RANGE	11-39T

WHEELS

FRONT HUB	SHIMANO NEXUS DH-3D37
REAR HUB	SHIMANO TOURNEY TX505
RIMS	KROSS ALUMINIUM 622 x 25
TIRES	SCHWALBE SILENTO 28 x 1,6

COMPONENTS

HANDLEBAR	ALUMINIUM 640 mm 31.8
HANDLEBAR STEM	ALUMINIUM 90 mm/31,8 REG
SEAT POST	AMORTIZED 31,6 x 350 mm
HEADSET	FP-H813PL 1-1/8"
SADDLE	SELLE ROYAL LOOKIN RVS MOD W
GRIPS	PROPALM GRIPPEN
PEDALS	FP-910
CARRIER	STANDWELL ALUMINIUM 28" 25 kg
FRONT LIGHT	AXA ECHO DYNAMO/EBIKE
REAR LIGHT	AXA JUNO DYNAMO/EBIKE
MUDGUARDS	TUBUS TW. SZT. 28"
KICK STAND	CENTRAL

GEOMETRY

SIZE	DM	DL
FS - FRAME SIZE*	17	19
ST - SEAT TUBE LENGTH**	430	480
TT - TOP TUBE LENGTH**	560	570
HT - HEAD TUBE LENGTH**	140	140
SA - SEAT TUBE ANGLE***	74	74
HA - HEAD TUBE ANGLE***	70	70
CS - CHAINSTAY LENGTH**	460	460
WB - WHEELBASE**	1084	1094
REACH**	385	395
STACK**	610	610
BB DROP**	60	60

* dimension in inches, ** dimension in mm, *** dimension in degrees

TRANS 5.0

NEW



SKU	SIZE	COLOUR	FINISH
KRTR5Z28X19M006158	M	black-gray	gloss
KRTR5Z28X21M006159	L	black-gray	gloss
KRTR5Z28X23M006160	XL	black-gray	gloss
KRTR5Z28X19M006161	M	khaki-black	mat
KRTR5Z28X21M006162	L	khaki-black	mat
KRTR5Z28X23M006163	XL	khaki-black	mat

GEAR RATIO 2 x 9

WHEEL DIAMETER 28"

COLOUR VARIANTS



FRAME

FRAME	ALUMINIUM PERFORMANCE
FORK	SR SUNTOUR NEX HLO
FORK TRAVEL	63 mm
SIZES	M(19"), L(21"), XL(23")

DRIVETRAIN

FRONT DERAILLEUR	SIMANO CUES FD U4010
REAR DERAILLEUR	SIMANO CUES RD U3020
FRONT BRAKE	SHIMANO MT200
REAR BRAKE	SHIMANO MT200
BRAKE LEVERS	SHIMANO MT200
BRAKE DISCS	SHIMANO RT26 160 6B
SHIFTERS	SHIMANO CUES U4000
CRANKSET	SHIMANO FC-U4010 CUES
SPROCKETS	46T-30T/170 mm
BOTTOM BRACKET	SHIMANO BB-MT501
CHAIN	SHIMANO LG500
CASSETTE/FREEWHEEL	SHIMANO CUES LG300
CASSETTE/FREEWHEEL RANGE	11-36T

WHEELS

FRONT HUB	SHIMANO NEXUS DH-3D32
REAR HUB	GULI GL-B43R
RIMS	KROSS ALUMINIUM 622 x 19
TIRES	WANDA P1024 28 x 1,5

COMPONENTS

HANDLEBAR	STEEL 610 mm 25.4
HANDLEBAR STEM	ALUMINIUM 110/25,4 REG
SEAT POST	AMORTIZED 31,6 x 350 mm
HEADSET	FP-H805A; 1 1/8"
SADDLE	SELLE ROYAL LOOKIN RVS MOD M
GRIPS	PROPALM GRIPPEN
PEDALS	FP-910
CARRIER	STANDWELL ALUMINIUM 28" 25 kg
FRONT LIGHT	AXA ECHO DYNAMO/EBIKE
REAR LIGHT	AXA JUNO DYNAMO/EBIKE
MUDGUARDS	TUBUS TW. SZT. 28"
KICK STAND	URSUS CENTRAL

GEOMETRY

SIZE	M	L	XL
FS - FRAME SIZE*	19	21	23
ST - SEAT TUBE LENGTH**	480	530	580
TT - TOP TUBE LENGTH**	570	585	600
HT - HEAD TUBE LENGTH**	140	140	160
SA - SEAT TUBE ANGLE***	74	74	74
HA - HEAD TUBE ANGLE***	70	70	70
CS - CHAINSTAY LENGTH**	460	460	460
WB - WHEELBASE**	1094	1109	1125
REACH**	395	410	420
STACK**	610	610	629
BB DROP**	60	60	60

* dimension in inches, ** dimension in mm, *** dimension in degrees

TRANS 5.0

NEW



SKU	SIZE	COLOUR	FINISH
KRTR5Z28X17W006154	DM	ruby red-black	gloss
KRTR5Z28X19W006155	DL	ruby red-black	gloss
KRTR5Z28X17W006156	DM	pearly-black	gloss
KRTR5Z28X19W006157	DL	pearly-black	gloss

GEAR RATIO 2 x 9

WHEEL DIAMETER 28"

COLOUR VARIANTS



FRAME

FRAME	ALUMINIUM 6061
FORK	SR SUNTOUR NEX HLO
FORK TRAVEL	63 mm
SIZES	DM(17"), DL(19")

DRIVETRAIN

FRONT DERAILLEUR	SIMANO CUES FD U4010
REAR DERAILLEUR	SIMANO CUES RD U3020
FRONT BRAKE	SHIMANO MT200
REAR BRAKE	SHIMANO MT200
BRAKE LEVERS	SHIMANO MT200
BRAKE DISCS	SHIMANO RT26 160 6B
SHIFTERS	SHIMANO CUES U4000
CRANKSET	SHIMANO FC-U4010 CUES
SPROCKETS	46T-30T/170 mm
BOTTOM BRACKET	SHIMANO BB-MT501
CHAIN	SHIMANO LG500
CASSETTE/FREEWHEEL	SHIMANO CUES LG300
CASSETTE/FREEWHEEL RANGE	11-36T

WHEELS

FRONT HUB	SHIMANO NEXUS DH-3D32
REAR HUB	GULI GL-B43R
RIMS	KROSS ALUMINIUM 622 x 19
TIRES	WANDA P1024 28 x 1,5

COMPONENTS

HANDLEBAR	STEEL 610 mm 25.4
HANDLEBAR STEM	ALUMINIUM 90/25,4 REG
SEAT POST	AMORTIZED 31,6 x 350 mm
HEADSET	FP-H805A; 1 1/8"
SADDLE	SELLE ROYAL LOOKIN RVS MOD W
GRIPS	PROPALM GRIPPEN
PEDALS	FP-910
CARRIER	STANDWELL ALUMINIUM 28" 25 kg
FRONT LIGHT	AXA ECHO DYNAMO/EBIKE
REAR LIGHT	AXA JUNO DYNAMO/EBIKE
MUDGUARDS	TUBUS TW. SZT. 28"
KICK STAND	URSUS CENTRAL

GEOMETRY

SIZE	DM	DL
FS - FRAME SIZE*	17	19
ST - SEAT TUBE LENGTH**	430	480
TT - TOP TUBE LENGTH**	560	570
HT - HEAD TUBE LENGTH**	140	140
SA - SEAT TUBE ANGLE***	74	74
HA - HEAD TUBE ANGLE***	70	70
CS - CHAINSTAY LENGTH**	460	460
WB - WHEELBASE**	1084	1094
REACH**	385	395
STACK**	610	610
BB DROP**	60	60

* dimension in inches, ** dimension in mm, *** dimension in degrees

TRANS 5.0



GEAR RATIO 3 x 8

WHEEL DIAMETER 28"

COLOUR VARIANTS



SKU	SIZE	COLOUR	FINISH
KRTR5Z28X19M002594	M	khaki-black	mat

FRAME

FRAME	ALUMINIUM PERFORMANCE
FORK	SR SUNTOUR NEX HLO
FORK TRAVEL	63 mm
SIZES	M(19")

DRIVETRAIN

FRONT DERAILLEUR	SHIMANO TOURNEY TY710
REAR DERAILLEUR	SHIMANO DEORE M592
FRONT BRAKE	SHIMANO ALTUS ST-EF505
REAR BRAKE	SHIMANO MT200
BRAKE LEVERS	SHIMANO ALTUS ST-EF505
BRAKE DISCS	SHIMANO RT10 160 CL
SHIFTERS	SHIMANO EF505
CRANKSET	ALUMINIUM
SPROCKETS	48T-38T-28T/170 mm
BOTTOM BRACKET	FP-B902
CHAIN	KMC HV700
CASSETTE/FREEWHEEL	SHIMANO ALTUS HG31
CASSETTE/FREEWHEEL RANGE	11-32T

WHEELS

FRONT HUB	SHIMANO DH3D37
REAR HUB	SHIMANO TX505
RIMS	KROSS ALUMINIUM 622 x 19
TIRES	SCHWALBE SILENTO 28 x 1,6

COMPONENTS

HANDLEBAR	STEEL 610 mm 25.4
HANDLEBAR STEM	ALUMINIUM 90/25,4 REG
SEAT POST	AMORTIZED 27,2 x 350 mm
HEADSET	FP-H805A; 1 1/8"
SADDLE	SELLE ROYAL LOOKIN RVS MOD M
GRIPS	KROSS GRIPEN
PEDALS	FP-910
CARRIER	BUCHEL ALUMINIUM 28" 15 kg
FRONT LIGHT	AXA ECHO DYNAMO/EBIKE
REAR LIGHT	AXA X-RAY
MUDGUARDS	TUBUS
KICK STAND	CENTRAL

GEOMETRY

SIZE	M
FS - FRAME SIZE*	19
ST - SEAT TUBE LENGTH**	480
TT - TOP TUBE LENGTH**	570
HT - HEAD TUBE LENGTH**	140
SA - SEAT TUBE ANGLE***	74
HA - HEAD TUBE ANGLE***	70
CS - CHAINSTAY LENGTH**	460
WB - WHEELBASE**	1094
REACH**	395
STACK**	610
BB DROP**	60

* dimension in inches, ** dimension in mm, *** dimension in degrees

TRANS 4.0



SKU	SIZE	COLOUR	FINISH
KRTR4Z28X19M003686	M	black-gray	gloss
KRTR4Z28X21M003688	L	black-gray	gloss
KRTR4Z28X23M003690	XL	black-gray	gloss
KRTR4Z28X19M003687	M	ruby red-black	gloss
KRTR4Z28X21M003689	L	ruby red-black	gloss
KRTR4Z28X23M003691	XL	ruby red-black	gloss

GEAR RATIO 3 x 7

WHEEL DIAMETER 28"

COLOUR VARIANTS



FRAME

FRAME	ALUMINIUM PERFORMANCE
FORK	SR SUNTOUR NEX
FORK TRAVEL	63 mm
SIZES	M(19"), L(21"), XL(23")

DRIVETRAIN

FRONT DERAILLEUR	SHIMANO TOURNEY TY710
REAR DERAILLEUR	SHIMANO ACERA M360
FRONT BRAKE	SHIMANO ALTUS ST-EF505
REAR BRAKE	SHIMANO MT200
BRAKE LEVERS	SHIMANO ALTUS ST-EF505
SHIFTERS	SHIMANO EF500
CRANKSET	ALUMINIUM
SPROCKETS	48T-38T-28T/170 mm
BOTTOM BRACKET	FP-B902
CHAIN	KMC P704
CASSETTE/FREEWHEEL	SHIMANO ALTUS HG31
CASSETTE/FREEWHEEL RANGE	11-32T

WHEELS

FRONT HUB	SHIMANO NEXUS C3000
REAR HUB	SHIMANO RM50
RIMS	KROSS ALUMINIUM 622 x 19
TIRES	WANDA P1024 28 x 1,5

COMPONENTS

HANDLEBAR	STEEL 610 mm 25.4
HANDLEBAR STEM	ALUMINIUM 110/25,4 REG
SEAT POST	AMORTIZED 31,6 x 350 mm
HEADSET	FP-H815 O1-1/8"
SADDLE	SELLE ROYAL LOOKIN RVS MOD M
GRIPS	KROSS GRIPPEN
PEDALS	FP-910
CARRIER	STANDWELL ALUMINIUM 28" 25 kg
FRONT LIGHT	AXA ECHO 15
REAR LIGHT	AXA X-RAY STEADY
MUDGUARDS	TUBUS
KICK STAND	CENTRAL

GEOMETRY

SIZE	M	L	XL
FS - FRAME SIZE*	19	21	23
ST - SEAT TUBE LENGTH**	480	530	580
TT - TOP TUBE LENGTH**	570	585	600
HT - HEAD TUBE LENGTH**	140	140	160
SA - SEAT TUBE ANGLE***	74	74	74
HA - HEAD TUBE ANGLE***	70	70	70
CS - CHAINSTAY LENGTH**	460	460	460
WB - WHEELBASE**	1094	1109	1125
REACH**	395	410	420
STACK**	610	610	629
BB DROP**	60	60	60

* dimension in inches, ** dimension in mm, *** dimension in degrees

TRANS 4.0



GEAR RATIO 3 x 7

WHEEL DIAMETER 28"

COLOUR VARIANTS



SKU	SIZE	COLOUR	FINISH
KRTR4Z28X17W003682	DM	turquoise-white	mat
KRTR4Z28X17W003683	DM	graphite-white	gloss

FRAME

FRAME	ALUMINIUM PERFORMANCE
FORK	SR SUNTOUR M3010
FORK TRAVEL	50mm
SIZES	DM(17")

DRIVETRAIN

FRONT DERAILLEUR	SHIMANO TOURNEY TY510
REAR DERAILLEUR	SHIMANO ACERA T3000
FRONT BRAKE	V-BRAKE
REAR BRAKE	V-BRAKE
BRAKE LEVERS	SHIMANO ACERA ST-EF500
SHIFTERS	SHIMANO EF500
CRANKSET	ALUMINIUM
SPROCKETS	48T-38T-28T/170 mm
BOTTOM BRACKET	FP-B902
CHAIN	KMC HV500
CASSETTE/FREEWHEEL	SHIMANO ALTUS HG200
CASSETTE/FREEWHEEL RANGE	12-28T

WHEELS

FRONT HUB	SHIMANO NEXUS C3000
REAR HUB	SHIMANO RM50
RIMS	KROSS ALUMINIUM 622 x 19
TIRES	WANDA P1024 28 x 1,5

COMPONENTS

HANDLEBAR	STEEL 610 mm 25.4
HANDLEBAR STEM	ALUMINIUM 90/25,4 REG
SEAT POST	AMORTIZED 27,2 x 350 mm
HEADSET	FP-H815 O1-1/8"
SADDLE	SELLE ROYAL LOOKIN RVS MOD W
GRIPS	KROSS GRIPPEN
PEDALS	FP-910
CARRIER	BUCHEL ALUMINIUM 28" 25 kg
FRONT LIGHT	AXA ECHO DYNAMO/EBIKE
REAR LIGHT	AXA X-RAY
MUDGUARDS	TUBUS
KICK STAND	CENTRAL

GEOMETRY

SIZE	DM
FS - FRAME SIZE*	17
ST - SEAT TUBE LENGTH**	430
TT - TOP TUBE LENGTH**	560
HT - HEAD TUBE LENGTH**	140
SA - SEAT TUBE ANGLE***	74
HA - HEAD TUBE ANGLE***	70
CS - CHAINSTAY LENGTH**	460
WB - WHEELBASE**	1084
REACH**	385
STACK**	610
BB DROP**	60

* dimension in inches, ** dimension in mm, *** dimension in degrees

TRANS 4.0



SKU	SIZE	COLOUR	FINISH
KRTR4Z28X19M005302	M	black-gray	gloss
KRTR4Z28X21M005303	L	black-gray	gloss
KRTR4Z28X23M005304	XL	black-gray	gloss

GEAR RATIO 3 x 7

WHEEL DIAMETER 28"

COLOUR VARIANTS



FRAME

FRAME	ALUMINIUM PERFORMANCE
FORK	SR SUNTOUR NEX
FORK TRAVEL	63 mm
SIZES	M(19"), L(21"), XL(23")

DRIVETRAIN

FRONT DERAILLEUR	SHIMANO TOURNEY TY710
REAR DERAILLEUR	SHIMANO ACERA M360
FRONT BRAKE	SHIMANO ALTUS ST-EF505
REAR BRAKE	SHIMANO MT200
BRAKE LEVERS	SHIMANO ALTUS ST-EF505
SHIFTERS	SHIMANO EF500
CRANKSET	ALUMINIUM
SPROCKETS	48T-38T-28T/170 mm
BOTTOM BRACKET	FP-B902
CHAIN	KMC P704
CASSETTE/FREEWHEEL	SHIMANO ALTUS HG31
CASSETTE/FREEWHEEL RANGE	11-32T

WHEELS

FRONT HUB	SHIMANO NEXUS C3000
REAR HUB	SHIMANO RM50
RIMS	KROSS ALUMINIUM 622 x 19
TIRES	WANDA P1024 28 x 1,5

COMPONENTS

HANDLEBAR	STEEL 610 mm 25.4
HANDLEBAR STEM	ALUMINIUM 110/25,4 REG
SEAT POST	AMORTIZED 31,6 x 350 mm
HEADSET	FP-H815 O1-1/8"
SADDLE	SELLE ROYAL LOOKIN RVS MOD M
GRIPS	KROSS GRIPPEN
PEDALS	FP-910
CARRIER	STANDWELL ALUMINIUM 28" 25 kg
FRONT LIGHT	AXA ECHO 15
REAR LIGHT	AXA X-RAY STEADY
MUDGUARDS	TUBUS
KICK STAND	CENTRAL

GEOMETRY

SIZE	M	L	XL
FS - FRAME SIZE*	19	21	23
ST - SEAT TUBE LENGTH**	480	530	580
TT - TOP TUBE LENGTH**	570	585	600
HT - HEAD TUBE LENGTH**	140	140	160
SA - SEAT TUBE ANGLE***	74	74	74
HA - HEAD TUBE ANGLE***	70	70	70
CS - CHAINSTAY LENGTH**	460	460	460
WB - WHEELBASE**	1094	1109	1125
REACH**	395	410	420
STACK**	610	610	629
BB DROP**	60	60	60

* dimension in inches, ** dimension in mm, *** dimension in degrees

TRANS 4.0



SKU	SIZE	COLOUR	FINISH
KRTR4Z28X17W005298	DM	turquoise-gray	mat
KRTR4Z28X19W005299	DL	turquoise-gray	mat
KRTR4Z28X17W005300	DM	graphite-gray	gloss
KRTR4Z28X19W005301	DL	graphite-gray	gloss

GEAR RATIO 3 x 7

WHEEL DIAMETER 28"

COLOUR VARIANTS



FRAME

FRAME	ALUMINIUM PERFORMANCE
FORK	SR SUNTOUR NEX
FORK TRAVEL	63 mm
SIZES	DM(17"), DL(19")

DRIVETRAIN

FRONT DERAILLEUR	SHIMANO TOURNEY TY710
REAR DERAILLEUR	SHIMANO ACERA M360
FRONT BRAKE	SHIMANO ALTUS ST-EF505
REAR BRAKE	SHIMANO MT200
BRAKE LEVERS	SHIMANO ALTUS ST-EF505
SHIFTERS	SHIMANO EF500
CRANKSET	ALUMINIUM
SPROCKETS	48T-38T-28T/170 mm
BOTTOM BRACKET	FP-B902
CHAIN	KMC P704
CASSETTE/FREEWHEEL	SHIMANO ALTUS HG31
CASSETTE/FREEWHEEL RANGE	11-32T

WHEELS

FRONT HUB	SHIMANO NEXUS C3000
REAR HUB	SHIMANO RM50
RIMS	KROSS ALUMINIUM 622 x 19
TIRES	WANDA P1024 28 x 1,5

COMPONENTS

HANDLEBAR	STEEL 610 mm 25.4
HANDLEBAR STEM	ALUMINIUM 90/25,4 REG
SEAT POST	AMORTIZED 31,6 x 350 mm
HEADSET	FP-H815 O1-1/8"
SADDLE	SELLE ROYAL LOOKIN RVS MOD W
GRIPS	KROSS GRIPPEN
PEDALS	FP-910
CARRIER	STANDWELL ALUMINIUM 28" 25 kg
FRONT LIGHT	AXA ECHO 15
REAR LIGHT	AXA X-RAY STEADY
MUDGUARDS	TUBUS
KICK STAND	CENTRAL

GEOMETRY

SIZE	DM	DL
FS - FRAME SIZE*	17	19
ST - SEAT TUBE LENGTH**	430	480
TT - TOP TUBE LENGTH**	560	570
HT - HEAD TUBE LENGTH**	140	140
SA - SEAT TUBE ANGLE***	74	74
HA - HEAD TUBE ANGLE***	70	70
CS - CHAINSTAY LENGTH**	460	460
WB - WHEELBASE**	1084	1094
REACH**	385	395
STACK**	610	610
BB DROP**	60	60

* dimension in inches, ** dimension in mm, *** dimension in degrees

TRANS 3.0



SKU	SIZE	COLOUR	FINISH
KRTR3Z28X19M003676	M	black-gray	mat
KRTR3Z28X21M003678	L	black-gray	mat
KRTR3Z28X23M003680	XL	black-gray	mat
KRTR3Z28X19M003677	M	grey-black	gloss
KRTR3Z28X21M003679	L	grey-black	gloss
KRTR3Z28X23M003681	XL	grey-black	gloss

GEAR RATIO 3 x 7

WHEEL DIAMETER 28"

COLOUR VARIANTS



FRAME

FRAME	ALUMINIUM PERFORMANCE
FORK	SR SUNTOUR NEX
FORK TRAVEL	63 mm
SIZES	M(19"), L(21"), XL(23")

DRIVETRAIN

FRONT DERAILLEUR	SHIMANO TOURNEY TY710
REAR DERAILLEUR	SHIMANO ACERA M360
FRONT BRAKE	MECHANICAL DISC
REAR BRAKE	MECHANICAL DISC
BRAKE LEVERS	SHIMANO ACERA ST-EF500
SHIFTERS	SHIMANO EF500
CRANKSET	ALUMINIUM
SPROCKETS	48T-38T-28T/170 mm
BOTTOM BRACKET	FP-B902
CHAIN	KMC P704
CASSETTE/FREEWHEEL	SHIMANO ALTUS HG31
CASSETTE/FREEWHEEL RANGE	11-32T

WHEELS

FRONT HUB	SHIMANO NEXUS C3000
REAR HUB	GL-B01R
RIMS	KROSS ALUMINIUM 622 x 19
TIRES	WANDA P1024 28 x 1,5

COMPONENTS

HANDLEBAR	STEEL 610 mm 25.4
HANDLEBAR STEM	ALUMINIUM 110/25,4 REG
SEAT POST	AMORTIZED 31,6 x 350 mm
HEADSET	FP-H815 O1-1/8"
SADDLE	YIBOTONG YBT-K607
GRIPS	KROSS GRIPPEN
PEDALS	FP-804
CARRIER	STANDWELL ALUMINIUM 28" 25 kg
FRONT LIGHT	HERRMANS H-IKE BATTERY
REAR LIGHT	AXA JUNO BATTERY
MUDGUARDS	TUBUS
KICK STAND	CENTRAL

GEOMETRY

SIZE	M	L	XL
FS - FRAME SIZE*	19	21	23
ST - SEAT TUBE LENGTH**	480	530	580
TT - TOP TUBE LENGTH**	570	585	600
HT - HEAD TUBE LENGTH**	140	140	160
SA - SEAT TUBE ANGLE***	74	74	74
HA - HEAD TUBE ANGLE***	70	70	70
CS - CHAINSTAY LENGTH**	460	460	460
WB - WHEELBASE**	1094	1109	1125
REACH**	395	410	420
STACK**	610	610	629
BB DROP**	60	60	60

* dimension in inches, ** dimension in mm, *** dimension in degrees

TRANS 3.0



SKU	SIZE	COLOUR	FINISH
KRTR3Z28X19M005295	M	black-gray	mat
KRTR3Z28X21M005296	L	black-gray	mat
KRTR3Z28X23M005297	XL	black-gray	mat

GEAR RATIO 3 x 7

WHEEL DIAMETER 28"

COLOUR VARIANTS



FRAME

FRAME	ALUMINIUM PERFORMANCE
FORK	SR SUNTOUR NEX
FORK TRAVEL	63 mm
SIZES	M(19"), L(21"), XL(23")

DRIVETRAIN

FRONT DERAILLEUR	SHIMANO TOURNEY TY510
REAR DERAILLEUR	SHIMANO ACERA M360
FRONT BRAKE	MECHANICAL DISC
REAR BRAKE	MECHANICAL DISC
BRAKE LEVERS	SHIMANO ACERA ST-EF500
SHIFTERS	SHIMANO EF500
CRANKSET	ALUMINIUM
SPROCKETS	48T-38T-28T/170 mm
BOTTOM BRACKET	FP-B902
CHAIN	KMC P704
CASSETTE/FREEWHEEL	SHIMANO ALTUS HG31
CASSETTE/FREEWHEEL RANGE	11-32T

WHEELS

FRONT HUB	SHIMANO NEXUS C3000
REAR HUB	GL-B01R
RIMS	KROSS ALUMINIUM 622 x 19
TIRES	WANDA P1024 28 x 1,5

COMPONENTS

HANDLEBAR	STEEL 610 mm 25.4
HANDLEBAR STEM	ALUMINIUM 110/25,4 REG
SEAT POST	AMORTIZED 31,6 x 350 mm
HEADSET	FP-H815 O1-1/8"
SADDLE	YIBOTONG YBT-K607
GRIPS	KROSS GRIPPEN
PEDALS	FP-804
CARRIER	STANDWELL ALUMINIUM 28" 25 kg
FRONT LIGHT	AXA ECHO 15
REAR LIGHT	BUHEL ROUTE 66
MUDGUARDS	TUBUS
KICK STAND	CENTRAL

GEOMETRY

SIZE	M	L	XL
FS - FRAME SIZE*	19	21	23
ST - SEAT TUBE LENGTH**	480	530	580
TT - TOP TUBE LENGTH**	570	585	600
HT - HEAD TUBE LENGTH**	140	140	160
SA - SEAT TUBE ANGLE***	74	74	74
HA - HEAD TUBE ANGLE***	70	70	70
CS - CHAINSTAY LENGTH**	460	460	460
WB - WHEELBASE**	1094	1109	1125
REACH**	395	410	420
STACK**	610	610	629
BB DROP**	60	60	60

* dimension in inches, ** dimension in mm, *** dimension in degrees

TRANS 3.0



SKU	SIZE	COLOUR	FINISH
KRTR3Z28X17W003672	DM	white-gray	gloss
KRTR3Z28X19W003674	DL	white-gray	gloss
KRTR3Z28X17W003673	DM	blue-gray	gloss
KRTR3Z28X19W003675	DL	blue-gray	gloss
KRTR3Z28X17W005291	DM	white-gray	gloss
KRTR3Z28X19W005292	DL	white-gray	gloss
KRTR3Z28X17W005293	DM	blue-gray	gloss
KRTR3Z28X19W005294	DL	blue-gray	gloss

GEAR RATIO 3 x 7

WHEEL DIAMETER 28"

COLOUR VARIANTS



FRAME

FRAME	ALUMINIUM PERFORMANCE
FORK	SR SUNTOUR NEX
FORK TRAVEL	63 mm
SIZES	DM(17"), DL(19")

DRIVETRAIN

FRONT DERAILLEUR	SHIMANO TOURNEY TY710
REAR DERAILLEUR	SHIMANO ACERA M360
FRONT BRAKE	MECHANICAL DISC
REAR BRAKE	MECHANICAL DISC
BRAKE LEVERS	SHIMANO ACERA ST-EF500
SHIFTERS	SHIMANO EF500
CRANKSET	ALUMINIUM
SPROCKETS	48T-38T-28T/170 mm
BOTTOM BRACKET	FP-B902
CHAIN	KMC P704
CASSETTE/FREEWHEEL	SHIMANO ALTUS HG31
CASSETTE/FREEWHEEL RANGE	11-32T

WHEELS

FRONT HUB	SHIMANO NEXUS C3000
REAR HUB	GL-B01R
RIMS	KROSS ALUMINIUM 622 x 19
TIRES	WANDA P1024 28 x 1,5

COMPONENTS

HANDLEBAR	STEEL 610 mm 25.4
HANDLEBAR STEM	ALUMINIUM 90/25,4 REG
SEAT POST	AMORTIZED 31,6 x 350 mm
HEADSET	FP-H815 O1-1/8"
SADDLE	YIBOTONG YBT-K607
GRIPS	KROSS GRIPPEN
PEDALS	FP-804
CARRIER	STANDWELL ALUMINIUM 28" 25 kg
FRONT LIGHT	HERRMANS H-IKE BATTERY
REAR LIGHT	AXA JUNO BATTERY
MUDGUARDS	TUBUS
KICK STAND	CENTRAL

GEOMETRY

SIZE	DM	DL
FS - FRAME SIZE*	17	19
ST - SEAT TUBE LENGTH**	430	480
TT - TOP TUBE LENGTH**	560	570
HT - HEAD TUBE LENGTH**	140	140
SA - SEAT TUBE ANGLE***	74	74
HA - HEAD TUBE ANGLE***	70	70
CS - CHAINSTAY LENGTH**	460	460
WB - WHEELBASE**	1084	1094
REACH**	385	395
STACK**	610	610
BB DROP**	60	60

* dimension in inches, ** dimension in mm, *** dimension in degrees

TRANS 2.0



SKU	SIZE	COLOUR	FINISH
KRTR2Z28X19M004281	M	brown-black	gloss
KRTR2Z28X21M004925	L	brown-black	gloss
KRTR2Z28X19M004283	M	black-gray	gloss
KRTR2Z28X21M004926	L	black-gray	gloss

GEAR RATIO 3 x 7

WHEEL DIAMETER 28"

COLOUR VARIANTS



FRAME

FRAME	ALUMINIUM PERFORMANCE
FORK	KROSS
FORK TRAVEL	30 mm
SIZES	M(19"), L(21")

DRIVETRAIN

FRONT DERAILLEUR	SHIMANO TOURNEY TY510
REAR DERAILLEUR	SHIMANO ALTUS M310
FRONT BRAKE	V-BRAKE
REAR BRAKE	V-BRAKE
BRAKE LEVERS	SHIMANO EF500
SHIFTERS	SHIMANO EF500
CRANKSET	ALUMINIUM
SPROCKETS	48T-38T-28T/170 mm
BOTTOM BRACKET	FP-B902
CHAIN	YBN S50
CASSETTE/FREEWHEEL	SHIMANO MF-TZ500
CASSETTE/FREEWHEEL RANGE	14-28T

WHEELS

FRONT HUB	GL-B01F
REAR HUB	GL-B01R
RIMS	KROSS
TIRES	WANDA P1024 28 x 1,5

COMPONENTS

HANDLEBAR	STAL 610 mm
HANDLEBAR STEM	ALUMINIUM 110/25,4 REG
SEAT POST	ALUMINIUM 27,2 x 350 mm
HEADSET	FP-H815 O1-1/8"
SADDLE	YIBOTONG YBT-K607
GRIPS	KROSS GRIPPEN
PEDALS	FP-804
CARRIER	BUCHEL ALUMINIUM 28" 25 kg
FRONT LIGHT	BUCHEL OCEAN BATTERY
REAR LIGHT	BUCHEL TIVOLI BATTERY
MUDGUARDS	SIMPLA
KICK STAND	URSUS

GEOMETRY

SIZE	M	L
FS - FRAME SIZE*	19	21
ST - SEAT TUBE LENGTH**	480	530
TT - TOP TUBE LENGTH**	570	585
HT - HEAD TUBE LENGTH**	140	140
SA - SEAT TUBE ANGLE***	74	74
HA - HEAD TUBE ANGLE***	70	70
CS - CHAINSTAY LENGTH**	460	460
WB - WHEELBASE**	1094	1109
REACH**	395	410
STACK**	610	610
BB DROP**	60	60

* dimension in inches, ** dimension in mm, *** dimension in degrees

TRANS 2.0



SKU	SIZE	COLOUR	FINISH
KRTR2Z28X15W004274	DS	grey-rose gold	gloss
KRTR2Z28X17W004275	DM	grey-rose gold	gloss
KRTR2Z28X19W004276	DL	grey-rose gold	gloss
KRTR2Z28X15W004277	DS	black-gray	mat
KRTR2Z28X17W004278	DM	black-gray	mat
KRTR2Z28X19W004279	DL	black-gray	mat

GEAR RATIO 3 x 7

WHEEL DIAMETER 28"

COLOUR VARIANTS



FRAME

FRAME	ALUMINIUM PERFORMANCE
FORK	KROSS
FORK TRAVEL	30 mm
SIZES	DS(15"), DM(17"), DL(19")

DRIVETRAIN

FRONT DERAILLEUR	SHIMANO TOURNEY TY510
REAR DERAILLEUR	SHIMANO ALTUS M310
FRONT BRAKE	V-BRAKE
REAR BRAKE	V-BRAKE
BRAKE LEVERS	SHIMANO ACERA ST-EF500
SHIFTERS	SHIMANO EF500
CRANKSET	ALUMINIUM
SPROCKETS	48T-38T-28T/170 mm
BOTTOM BRACKET	FP-B902
CHAIN	YBN S50
CASSETTE/FREEWHEEL	SHIMANO TOURNEY MF-TZ500
CASSETTE/FREEWHEEL RANGE	14-28T

WHEELS

FRONT HUB	GL-B01F
REAR HUB	GL-B01R
RIMS	KROSS ALUMINIUM 622 x 19
TIRES	WANDA P1024 28 x 1,5

COMPONENTS

HANDLEBAR	STEEL 610 mm 25,4
HANDLEBAR STEM	ALUMINIUM 90/25,4 REG
SEAT POST	ALUMINIUM 27,2 x 350 mm
HEADSET	FP-H815 O1-1/8"
SADDLE	YIBOTONG YBT-K607
GRIPS	KROSS GRIPPEN
PEDALS	FP-804
CARRIER	BUCHEL ALUMINIUM 28" 25 kg
FRONT LIGHT	BUCHEL OCEAN BATTERY
REAR LIGHT	BUCHEL TIVOLI BATTERY
MUDGUARDS	SIMPLA
KICK STAND	URSUS

GEOMETRY

SIZE	DS	DM	DL
FS - FRAME SIZE*	15	17	19
ST - SEAT TUBE LENGTH**	380	430	480
TT - TOP TUBE LENGTH**	550	560	570
HT - HEAD TUBE LENGTH**	140	140	140
SA - SEAT TUBE ANGLE***	74	74	74
HA - HEAD TUBE ANGLE***	70	70	70
CS - CHAINSTAY LENGTH**	460	460	460
WB - WHEELBASE**	1074	1084	1094
REACH**	375	385	395
STACK**	610	610	610
BB DROP**	60	60	60

* dimension in inches, ** dimension in mm, *** dimension in degrees

TRANS 1.0



SKU	SIZE	COLOUR	FINISH
KRTR1Z28X17M002483	S	black-gray	gloss
KRTR1Z28X19M002484	M	black-gray	gloss
KRTR1Z28X21M002485	L	black-gray	gloss
KRTR1Z28X17M002490	S	grey-black	mat
KRTR1Z28X19M002491	M	grey-black	mat
KRTR1Z28X21M002492	L	grey-black	mat

GEAR RATIO 3 x 7

WHEEL DIAMETER 28"

COLOUR VARIANTS



FRAME

FRAME	ALUMINIUM PERFORMANCE
FORK	KROSS
FORK TRAVEL	30 mm
SIZES	S(17"), M(19"), L(21")

DRIVETRAIN

FRONT DERAILLEUR	SHIMANO TOURNEY TY510
REAR DERAILLEUR	SHIMANO TOURNEY TY300
FRONT BRAKE	V-BRAKE
REAR BRAKE	V-BRAKE
BRAKE LEVERS	SHIMANO TOURNEY ST-EF41
SHIFTERS	SHIMANO EF41
CRANKSET	WHEEL TOP
SPROCKETS	48T-38T-28T/170 mm
BOTTOM BRACKET	FP-B902
CHAIN	YBN S50
CASSETTE/FREEWHEEL	SHIMANO TOURNEY MF-TZ500
CASSETTE/FREEWHEEL RANGE	14-28T

WHEELS

FRONT HUB	GL-B01F-QR
REAR HUB	GL-B01R-QR
RIMS	KROSS ALUMINIUM 622 x 19
TIRES	WANDA P1024 28 x 1,5

COMPONENTS

HANDLEBAR	STEEL 610 mm 25.4
HANDLEBAR STEM	ALUMINIUM 90/25,4 REG
SEAT POST	ALUMINIUM 27,2 x 350 mm
HEADSET	FP-H815 O1-1/8"
SADDLE	YIBOTONG YBT-K607
GRIPS	KROSS GRIPPEN
PEDALS	FP-804
CARRIER	BUCHEL ALUMINIUM 28" 15 kg
FRONT LIGHT	BUCHEL OCEAN BATTERY
REAR LIGHT	BUCHEL TIVOLI BATTERY
MUDGUARDS	TUBUS
KICK STAND	CENTRAL

GEOMETRY

SIZE	S	M	L
FS - FRAME SIZE*	17	19	21
ST - SEAT TUBE LENGTH**	432	482	533
TT - TOP TUBE LENGTH**	560	570	585
HT - HEAD TUBE LENGTH**	140	140	140
SA - SEAT TUBE ANGLE***	70	70	70
HA - HEAD TUBE ANGLE***	74	74	73
CS - CHAINSTAY LENGTH**	460	460	460
WB - WHEELBASE**	1084	1094	1097
REACH**	385	395	397
STACK**	610	610	614
BB DROP**	60	60	60

* dimension in inches, ** dimension in mm, *** dimension in degrees

TRANS 1.0



SKU	SIZE	COLOUR	FINISH
KRTR1Z28X17W004265	DM	white-gray	gloss
KRTR1Z28X19W004266	DL	white-gray	gloss
KRTR1Z28X17W004268	DM	ruby red-gray	gloss
KRTR1Z28X19W004269	DL	ruby red-gray	gloss

GEAR RATIO 3 x 7

WHEEL DIAMETER 28"

COLOUR VARIANTS



FRAME

FRAME	ALUMINIUM PERFORMANCE
FORK	KROSS
FORK TRAVEL	30 mm
SIZES	DM(17"), DL(19")

DRIVETRAIN

FRONT DERAILLEUR	SHIMANO TOURNEY TY510
REAR DERAILLEUR	SHIMANO TOURNEY TY300
FRONT BRAKE	V-BRAKE
REAR BRAKE	V-BRAKE
BRAKE LEVERS	SHIMANO TOURNEY ST-EF41
SHIFTERS	SHIMANO EF41
CRANKSET	LANXI
SPROCKETS	48T-38T-28T/170 mm
BOTTOM BRACKET	FP-B902
CHAIN	YBN S50
CASSETTE/FREEWHEEL	SHIMANO TOURNEY MF-TZ500
CASSETTE/FREEWHEEL RANGE	14-28T

WHEELS

FRONT HUB	GL-B01F
REAR HUB	GL-B01R
RIMS	KROSS ALUMINIUM 622 x 19
TIRES	WANDA P1024 28 x 1,5

COMPONENTS

HANDLEBAR	STEEL 610 mm 25.4
HANDLEBAR STEM	ALUMINIUM 90/25,4 REG
SEAT POST	ALUMINIUM 27,2 x 350 mm
HEADSET	FP-H815 O1-1/8"
SADDLE	YIBOTONG YBT-K607
GRIPS	KROSS GRIPPEN
PEDALS	FP-804
CARRIER	BUCHEL ALUMINIUM 28" 25 kg
FRONT LIGHT	BUCHEL OCEAN BATTERY
REAR LIGHT	BUCHEL TIVOLI BATTERY
MUDGUARDS	SIMPLA
KICK STAND	URSUS

GEOMETRY

SIZE	DM	DL
FS - FRAME SIZE*	17	19
ST - SEAT TUBE LENGTH**	430	480
TT - TOP TUBE LENGTH**	560	570
HT - HEAD TUBE LENGTH**	140	140
SA - SEAT TUBE ANGLE***	74	74
HA - HEAD TUBE ANGLE***	70	70
CS - CHAINSTAY LENGTH**	460	460
WB - WHEELBASE**	1084	1094
REACH**	385	395
STACK**	610	610
BB DROP**	60	60

* dimension in inches, ** dimension in mm, *** dimension in degrees

TRANS 1.0



SKU	SIZE	COLOUR	FINISH
KRTR1Z28X15W002480	DS	black-gray	gloss
KRTR1Z28X17W002481	DM	black-gray	gloss
KRTR1Z28X15W002487	DS	white-gray	gloss
KRTR1Z28X17W002488	DM	white-gray	gloss
KRTR1Z28X19W002489	DL	white-gray	gloss
KRTR1Z28X15W002494	DS	ruby red-black	gloss
KRTR1Z28X17W002495	DM	ruby red-black	gloss
KRTR1Z28X19W002496	DL	ruby red-black	gloss

GEAR RATIO 3 x 7

WHEEL DIAMETER 28"

COLOUR VARIANTS



FRAME

FRAME	ALUMINIUM PERFORMANCE
FORK	KROSS
FORK TRAVEL	30 mm
SIZES	DS(15"), DM(17"), DL(19")

DRIVETRAIN

FRONT DERAILLEUR	SHIMANO TOURNEY TY510
REAR DERAILLEUR	SHIMANO TOURNEY TY300
FRONT BRAKE	V-BRAKE
REAR BRAKE	V-BRAKE
BRAKE LEVERS	SHIMANO TOURNEY ST-EF41
SHIFTERS	SHIMANO EF41
CRANKSET	WHEEL TOP
SPROCKETS	48T-38T-28T/170 mm
BOTTOM BRACKET	FP-B902
CHAIN	YBN S50
CASSETTE/FREEWHEEL	SHIMANO TOURNEY MF-TZ500
CASSETTE/FREEWHEEL RANGE	14-28T

WHEELS

FRONT HUB	GL-B01F-QR
REAR HUB	GL-B01R-QR
RIMS	KROSS ALUMINIUM 622 x 19
TIRES	WANDA P1024 28 x 1,5

COMPONENTS

HANDLEBAR	STEEL 610 mm 25.4
HANDLEBAR STEM	ALUMINIUM 90/25,4 REG
SEAT POST	ALUMINIUM 27,2 x 350 mm
HEADSET	FP-H815 O1-1/8"
SADDLE	YIBOTONG YBT-K607
GRIPS	KROSS GRIPPEN
PEDALS	FP-804
CARRIER	BUHEL ALUMINIUM 28" 25 kg
FRONT LIGHT	BUHEL OCEAN BATTERY
REAR LIGHT	BUHEL TIVOLI BATTERY
MUDGUARDS	TUBUS
KICK STAND	CENTRAL

GEOMETRY

SIZE	DS	DM	DL
FS - FRAME SIZE*	15	17	19
ST - SEAT TUBE LENGTH**	381	431	482
TT - TOP TUBE LENGTH**	560	560	570
HT - HEAD TUBE LENGTH**	140	140	140
SA - SEAT TUBE ANGLE***	74	70	70
HA - HEAD TUBE ANGLE***	70	74	74
CS - CHAINSTAY LENGTH**	460	460	460
WB - WHEELBASE**	1084	1084	1094
REACH**	385	385	395
STACK**	610	610	610
BB DROP**	60	60	60

* dimension in inches, ** dimension in mm, *** dimension in degrees



CROSS BIKES

EVADO

Evado is a series of cross bikes designed to combine efficient riding on a variety of cycle paths and asphalt with the ability to handle light off-road terrain.

Combining these features results in a bike that will not only excel in urban conditions but also allow for exploration of woodland or gravel terrains.

New frame: our Evado bikes are equipped with a new lightweight frame optimized for comfort.

Tailor it to your needs: the bikes in the Evado range have places to fit mudguards, a rack or lighting, making them suitable for all conditions.





EVADO 7.0

NEW



GEAR RATIO 3 x 10

WHEEL DIAMETER 28"

COLOUR VARIANTS



SKU	SIZE	COLOUR	FINISH
KREV7Z28X19M005773	M	black-silver	gloss
KREV7Z28X21M005774	L	black-silver	gloss
KREV7Z28X23M005775	XL	black-silver	gloss

FRAME

FRAME	ALUMINIUM PERFORMANCE
FORK	SR SUNTOUR NEX HLO
FORK TRAVEL	63 mm
SIZES	M(19"), L(21"), XL(23")

DRIVETRAIN

FRONT DERAILLEUR	SHIMANO CUES U 4000
REAR DERAILLEUR	SHIMANO CUES RD U6020
FRONT BRAKE	SHIMANO MT200
REAR BRAKE	SHIMANO MT200
BRAKE LEVERS	SHIMANO MT201
BRAKE DISCS	SHIMANO RT10 160 CL
SHIFTERS	SHIMANO CUES U6000
CRANKSET	SHIMANO FC-U4010 CUES
SPROCKETS	40T-26T/170 mm
BOTTOM BRACKET	SHIMANO BB-MT501
CHAIN	SHIMANO LG500
CASSETTE/FREEWHEEL	SHIMANO CUES LG400
CASSETTE/FREEWHEEL RANGE	11-39T

WHEELS

FRONT HUB	SHIMANO TURNER TX505
REAR HUB	SHIMANO TOURNEY TX505
RIMS	KROSS ALUMINIUM 622 x 25
TIRES	SCHWALBE CX COMP 28 x 1,5

COMPONENTS

HANDLEBAR	ALUMINIUM 640 mm 31.8
HANDLEBAR STEM	ALUMINIUM 100 mm/31,8/7°
SEAT POST	ALUMINIUM 31,6 x 350 mm
HEADSET	FP-H813PL 1-1/8"
SADDLE	SELLE ROYAL LOOKIN SPORT
GRIPS	HERMANS ADRENALIN 3D02B
PEDALS	FP-971

GEOMETRY

SIZE	M	L	XL
FS - FRAME SIZE*	19	21	23
ST - SEAT TUBE LENGTH**	480	530	580
TT - TOP TUBE LENGTH**	570	585	600
HT - HEAD TUBE LENGTH**	140	140	160
SA - SEAT TUBE ANGLE***	74	74	74
HA - HEAD TUBE ANGLE***	70	70	70
CS - CHAINSTAY LENGTH**	460	460	460
WB - WHEELBASE**	1094	1109	1125
REACH**	395	410	420
STACK**	610	610	629
BB DROP**	60	60	60

* dimension in inches, ** dimension in mm, *** dimension in degrees

EVADO 7.0

NEW



SKU	SIZE	COLOUR	FINISH
KREV7Z28X17W005771	DM	white-turquoise	gloss
KREV7Z28X19W005772	DL	white-turquoise	gloss

GEAR RATIO 3 x 10

WHEEL DIAMETER 28"

COLOUR VARIANTS



FRAME

FRAME	ALUMINIUM 6061
FORK	SR SUNTOUR NEX HLO
FORK TRAVEL	63 mm
SIZES	DM(17"), DL(19")

DRIVETRAIN

FRONT DERAILLEUR	SHIMANO CUES U 4000
REAR DERAILLEUR	SHIMANO CUES RD U6020
FRONT BRAKE	SHIMANO MT200
REAR BRAKE	SHIMANO MT200
BRAKE LEVERS	SHIMANO MT201
BRAKE DISCS	SHIMANO RT10 160 CL
SHIFTERS	SHIMANO CUES U6000
CRANKSET	SHIMANO FC-U4010 CUES
SPROCKETS	40T-26T/170 mm
BOTTOM BRACKET	SHIMANO BB-MT501
CHAIN	SHIMANO LG500
CASSETTE/FREEWHEEL	SHIMANO CUES LG400
CASSETTE/FREEWHEEL RANGE	11-39T

WHEELS

FRONT HUB	SHIMANO TURNER TX505
REAR HUB	SHIMANO TOURNEY TX505
RIMS	KROSS ALUMINIUM 622 x 25
TIRES	SCHWALBE CX COMP 28 x 1,5

COMPONENTS

HANDLEBAR	ALUMINIUM 620 mm 31.8
HANDLEBAR STEM	ALUMINIUM 70 mm/31,8/7°
SEAT POST	ALUMINIUM 31,6 x 350 mm
HEADSET	FP-H813PL 1-1/8"
SADDLE	SELLE ROYAL LOOKIN SPORT
GRIPS	HERMANS ADRENALIN 3D02B
PEDALS	FP-971

GEOMETRY

SIZE	DM	DL
FS - FRAME SIZE*	17	19
ST - SEAT TUBE LENGTH**	430	480
TT - TOP TUBE LENGTH**	560	570
HT - HEAD TUBE LENGTH**	140	140
SA - SEAT TUBE ANGLE***	74	74
HA - HEAD TUBE ANGLE***	70	70
CS - CHAINSTAY LENGTH**	460	460
WB - WHEELBASE**	1084	1094
REACH**	385	395
STACK**	610	610
BB DROP**	60	60

* dimension in inches, ** dimension in mm, *** dimension in degrees

EVADO 5.0

NEW



SKU	SIZE	COLOUR	FINISH
KREV5Z28X19M005760	M	graphite-black	mat
KREV5Z28X21M005761	L	graphite-black	mat
KREV5Z28X23M005762	XL	graphite-black	mat
KREV5Z28X19M005763	M	black-green	gloss
KREV5Z28X21M005764	L	black-green	gloss
KREV5Z28X23M005765	XL	black-green	gloss

GEAR RATIO 2 x 9

WHEEL DIAMETER 28"

COLOUR VARIANTS



FRAME

FRAME	ALUMINIUM PERFORMANCE
FORK	SR SUNTOUR NEX HLO
FORK TRAVEL	63 mm
SIZES	M(19"), L(21"), XL(23")

DRIVETRAIN

FRONT DERAILLEUR	SHIMANO CUES U 4000
REAR DERAILLEUR	SHIMANO CUES RD U3020
FRONT BRAKE	SHIMANO MT200
REAR BRAKE	SHIMANO MT200
BRAKE LEVERS	SHIMANO MT200
BRAKE DISCS	POWER RT600 160 6B
SHIFTERS	SHIMANO CUES U4000
CRANKSET	SHIMANO FC-U4010 CUES
SPROCKETS	40T-26T/170 mm
BOTTOM BRACKET	SHIMANO BB-MT501
CHAIN	SHIMANO LG500
CASSETTE/FREEWHEEL	SHIMANO CUES LG300
CASSETTE/FREEWHEEL RANGE	11-36T

WHEELS

FRONT HUB	GULI GL-B43F
REAR HUB	GULI GL-B43R
RIMS	KROSS ALUMINIUM 622 x 19
TIRES	WANDA G5001 28 x 1,75

COMPONENTS

HANDLEBAR	ALUMINIUM 640 mm 31.8
HANDLEBAR STEM	ALUMINIUM 70 mm/31,8/7°
SEAT POST	ALUMINIUM 31,6 x 350 mm
HEADSET	FP-H813PL 1-1/8"
SADDLE	SELLE ROYAL SHADOW
GRIPS	HERMANS OXY DD29BL
PEDALS	FP-971

GEOMETRY

SIZE	M	L	XL
FS - FRAME SIZE*	19	21	23
ST - SEAT TUBE LENGTH**	480	530	580
TT - TOP TUBE LENGTH**	570	585	600
HT - HEAD TUBE LENGTH**	140	140	160
SA - SEAT TUBE ANGLE***	74	74	74
HA - HEAD TUBE ANGLE***	70	70	70
CS - CHAINSTAY LENGTH**	460	460	460
WB - WHEELBASE**	1094	1109	1125
REACH**	395	410	420
STACK**	610	610	629
BB DROP**	60	60	60

* dimension in inches, ** dimension in mm, *** dimension in degrees

EVADO 5.0

NEW



SKU	SIZE	COLOUR	FINISH
KREV5Z28X17W005756	DM	turquoise-green	gloss
KREV5Z28X19W005757	DL	turquoise-green	gloss
KREV5Z28X17W005758	DM	black-turquoise	gloss
KREV5Z28X19W005759	DL	black-turquoise	gloss

GEAR RATIO 2 x 9

WHEEL DIAMETER 28"

COLOUR VARIANTS



FRAME

FRAME	ALUMINIUM 6061
FORK	SR SUNTOUR NEX HLO
FORK TRAVEL	63 mm
SIZES	DM(17"), DL(19")

DRIVETRAIN

FRONT DERAILLEUR	SHIMANO CUES U 4000
REAR DERAILLEUR	SHIMANO CUES RD U3020
FRONT BRAKE	SHIMANO MT200
REAR BRAKE	SHIMANO MT200
BRAKE LEVERS	SHIMANO MT200
BRAKE DISCS	POWER RT600 160 6B
SHIFTERS	SHIMANO CUES U4000
CRANKSET	SHIMANO FC-U4010 CUES
SPROCKETS	40T-26T/170 mm
BOTTOM BRACKET	SHIMANO BB-MT501
CHAIN	SHIMANO LG500
CASSETTE/FREEWHEEL	SHIMANO CUES LG300
CASSETTE/FREEWHEEL RANGE	11-36T

WHEELS

FRONT HUB	GULI GL-B43F
REAR HUB	GULI GL-B43R
RIMS	KROSS ALUMINIUM 622 x 19
TIRES	WANDA G5001 28 x 1,75

COMPONENTS

HANDLEBAR	ALUMINIUM 620 mm 31.8
HANDLEBAR STEM	ALUMINIUM 70 mm/31,8/17°
SEAT POST	ALUMINIUM 31,6 x 300 mm
HEADSET	FP-H813PL 1-1/8"
SADDLE	SELLE ROYAL SHADOW
GRIPS	HERMANS OXY DD29BL
PEDALS	FP-971

GEOMETRY

SIZE	DM	DL
FS - FRAME SIZE*	17	19
ST - SEAT TUBE LENGTH**	430	480
TT - TOP TUBE LENGTH**	560	570
HT - HEAD TUBE LENGTH**	140	140
SA - SEAT TUBE ANGLE***	74	74
HA - HEAD TUBE ANGLE***	70	70
CS - CHAINSTAY LENGTH**	460	460
WB - WHEELBASE**	1084	1094
REACH**	385	395
STACK**	610	610
BB DROP**	60	60

* dimension in inches, ** dimension in mm, *** dimension in degrees

EVADO 5.0



SKU	SIZE	COLOUR	FINISH
KREV5Z28X19M003628	M	graphite-black	mat
KREV5Z28X21M003630	L	graphite-black	mat
KREV5Z28X23M003632	XL	graphite-black	mat
KREV5Z28X19M003629	M	black-green	gloss
KREV5Z28X21M003631	L	black-green	gloss
KREV5Z28X23M003633	XL	black-green	gloss

GEAR RATIO 3 x 9

WHEEL DIAMETER 28"

COLOUR VARIANTS



FRAME

FRAME	ALUMINIUM LITE
FORK	SR SUNTOUR NEX HLO
FORK TRAVEL	63 mm
SIZES	M(19"), L(21"), XL(23")

DRIVETRAIN

FRONT DERAILLEUR	SHIMANO ALTUS M370
REAR DERAILLEUR	SHIMANO ACERA T3000
FRONT BRAKE	SHIMANO MT200
REAR BRAKE	SHIMANO MT200
BRAKE LEVERS	SHIMANO MT200
BRAKE DISCS	DISC (160 mm)
SHIFTERS	SHIMANO ACERA M3000
CRANKSET	SHIMANO ACERA T3010
SPROCKETS	48T-36T-26T/170 mm
BOTTOM BRACKET	FP-B902
CHAIN	SHIMANO HG53
CASSETTE/FREEWHEEL	SHIMANO ALTUS HG200
CASSETTE/FREEWHEEL RANGE	11-32T

WHEELS

FRONT HUB	QR 9 mm
REAR HUB	QR 9 mm
RIMS	KROSS ALUMINIUM 622 x 19
TIRES	WANDA G5001 28 x 1,75

COMPONENTS

HANDLEBAR	ALUMINIUM 640 mm 31.8
HANDLEBAR STEM	ALUMINIUM 110 mm/31,8/7°
SEAT POST	ALUMINIUM 31,6 x 350 mm
HEADSET	1-1/8"
SADDLE	SELLE ROYAL SHADOW
GRIPS	HERRMANS OXY
PEDALS	FP-971

GEOMETRY

SIZE	M	L	XL
FS - FRAME SIZE*	19	21	23
ST - SEAT TUBE LENGTH**	480	530	580
TT - TOP TUBE LENGTH**	570	585	600
HT - HEAD TUBE LENGTH**	140	140	160
SA - SEAT TUBE ANGLE***	74	74	74
HA - HEAD TUBE ANGLE***	70	70	70
CS - CHAINSTAY LENGTH**	460	460	460
WB - WHEELBASE**	1094	1109	1125
REACH**	395	410	420
STACK**	610	610	629
BB DROP**	60	60	60

* dimension in inches, ** dimension in mm, *** dimension in degrees

EVADO 5.0



SKU	SIZE	COLOUR	FINISH
KREV5Z28X17W003624	DM	turquoise-green	gloss
KREV5Z28X19W003626	DL	turquoise-green	gloss
KREV5Z28X17W003625	DM	black-turquoise	gloss
KREV5Z28X19W003627	DL	black-turquoise	gloss

GEAR RATIO 3 x 9

WHEEL DIAMETER 28"

COLOUR VARIANTS



FRAME

FRAME	ALUMINIUM LITE
FORK	SR SUNTOUR NEX HLO
FORK TRAVEL	63 mm
SIZES	DM(17"), DL(19")

DRIVETRAIN

FRONT DERAILLEUR	SHIMANO ALTUS M370
REAR DERAILLEUR	SHIMANO ACERA T3000
FRONT BRAKE	SHIMANO MT200
REAR BRAKE	SHIMANO MT200
BRAKE LEVERS	SHIMANO MT200
BRAKE DISCS	DISC (160 mm)
SHIFTERS	SHIMANO ACERA M3000
CRANKSET	SHIMANO ACERA T3010
SPROCKETS	48T-36T-26T/170 mm
BOTTOM BRACKET	FP-B902
CHAIN	SHIMANO HG53
CASSETTE/FREEWHEEL	SHIMANO ALTUS HG200
CASSETTE/FREEWHEEL RANGE	11-32T

WHEELS

FRONT HUB	QR 9 mm
REAR HUB	QR 9 mm
RIMS	KROSS ALUMINIUM 622 x 19
TIRES	WANDA G5001 28 x 1,75

COMPONENTS

HANDLEBAR	ALUMINIUM 620 mm 31.8
HANDLEBAR STEM	ALUMINIUM 100 mm/31,8/7°
SEAT POST	ALUMINIUM 31,6 x 300 mm
HEADSET	1-1/8"
SADDLE	SELLE ROYAL SHADOW
GRIPS	HERRMANS OXY
PEDALS	FP-971

GEOMETRY

SIZE	DM	DL
FS - FRAME SIZE*	17	19
ST - SEAT TUBE LENGTH**	430	480
TT - TOP TUBE LENGTH**	560	570
HT - HEAD TUBE LENGTH**	140	140
SA - SEAT TUBE ANGLE***	74	74
HA - HEAD TUBE ANGLE***	70	70
CS - CHAINSTAY LENGTH**	460	460
WB - WHEELBASE**	1084	1094
REACH**	385	395
STACK**	610	610
BB DROP**	60	60

* dimension in inches, ** dimension in mm, *** dimension in degrees

EVADO 4.0

NEW



SKU	SIZE	COLOUR	FINISH
KREV4Z28X19M006720	M	graphite-red	gloss
KREV4Z28X21M006722	L	graphite-red	gloss
KREV4Z28X23M006724	XL	graphite-red	gloss
KREV4Z28X19M006721	M	black-green	mat
KREV4Z28X21M006723	L	black-green	mat
KREV4Z28X23M006725	XL	black-green	mat

GEAR RATIO 3 x 8

WHEEL DIAMETER 28"

COLOUR VARIANTS



FRAME

FRAME	ALUMINIUM PERFORMANCE
FORK	SR SUNTOUR NEX
FORK TRAVEL	63 mm
SIZES	M(19"), L(21"), XL(23")

DRIVETRAIN

FRONT DERAILLEUR	SHIMANO TOURNEY TY710
REAR DERAILLEUR	SHIMANO ACERA M360
FRONT BRAKE	SHIMANO ALTUS ST-EF505
REAR BRAKE	SHIMANO MT200
BRAKE LEVERS	SHIMANO ALTUS ST-EF505
BRAKE DISCS	POWER RT600 160 6B
SHIFTERS	SHIMANO ALTUS ST-EF505
CRANKSET	PROWHEEL TY-CM99
SPROCKETS	48T-38T-28T/170 mm
BOTTOM BRACKET	FP-B902
CHAIN	YBN S8
CASSETTE/FREEWHEEL	SHIMANO ALTUS HG31
CASSETTE/FREEWHEEL RANGE	11-32T

WHEELS

FRONT HUB	GULI GL-B43F
REAR HUB	GULI GL-B43R
RIMS	KROSS ALUMINIUM 622 x 19
TIRES	WANDA G5001 28 x 1,75

COMPONENTS

HANDLEBAR	ALUMINIUM 640 mm 31.8
HANDLEBAR STEM	ALUMINIUM 90 mm/31,8/7°
SEAT POST	AMORTIZED 31,6 x 350 mm
HEADSET	FP-H816 O1-1/8"
SADDLE	SELLE ROYAL SHADOW
GRIPS	HERMANS OXY DD29BL
PEDALS	FP-917N

GEOMETRY

SIZE	M	L	XL
FS - FRAME SIZE*	19	21	23
ST - SEAT TUBE LENGTH**	480	530	580
TT - TOP TUBE LENGTH**	570	585	600
HT - HEAD TUBE LENGTH**	140	140	160
SA - SEAT TUBE ANGLE***	74	74	74
HA - HEAD TUBE ANGLE***	70	70	70
CS - CHAINSTAY LENGTH**	460	460	460
WB - WHEELBASE**	1094	1109	1125
REACH**	395	410	420
STACK**	610	610	629
BB DROP**	60	60	60

* dimension in inches, ** dimension in mm, *** dimension in degrees

EVADO 4.0

NEW



SKU	SIZE	COLOUR	FINISH
KREV4Z28X17W006716	DM	ruby red-black	gloss
KREV4Z28X19W006718	DL	ruby red-black	gloss
KREV4Z28X17W006717	DM	black-raspberry	gloss
KREV4Z28X19W006719	DL	black-raspberry	gloss

GEAR RATIO 3 x 8

WHEEL DIAMETER 28"

COLOUR VARIANTS



FRAME

FRAME	ALUMINIUM 6061
FORK	SR SUNTOUR NEX
FORK TRAVEL	63 mm
SIZES	DM(17"), DL(19")

DRIVETRAIN

FRONT DERAILLEUR	SHIMANO TOURNEY TY710
REAR DERAILLEUR	SHIMANO ACERA M360
FRONT BRAKE	SHIMANO ALTUS ST-EF505
REAR BRAKE	SHIMANO MT200
BRAKE LEVERS	SHIMANO ALTUS ST-EF505
BRAKE DISCS	POWER RT600 160 6B
SHIFTERS	SHIMANO ALTUS ST-EF505
CRANKSET	PROWHEEL TY-CM99
SPROCKETS	48T-38T-28T/170 mm
BOTTOM BRACKET	FP-B902
CHAIN	YBN S8
CASSETTE/FREEWHEEL	SHIMANO ALTUS HG31
CASSETTE/FREEWHEEL RANGE	11-32T

WHEELS

FRONT HUB	GULI GL-B43F
REAR HUB	GULI GL-B43R
RIMS	KROSS ALUMINIUM 622 x 19
TIRES	WANDA G5001 28 x 1,75

COMPONENTS

HANDLEBAR	ALUMINIUM 640 mm 31.8
HANDLEBAR STEM	ALUMINIUM 75 mm/31,8/7°
SEAT POST	AMORTIZED 31,6 x 300 mm
HEADSET	FP-H816 O1-1/8"
SADDLE	SELLE ROYAL SHADOW
GRIPS	HERMANS OXY DD29BL
PEDALS	FP-917N

GEOMETRY

SIZE	DM	DL
FS - FRAME SIZE*	17	19
ST - SEAT TUBE LENGTH**	430	480
TT - TOP TUBE LENGTH**	560	570
HT - HEAD TUBE LENGTH**	140	140
SA - SEAT TUBE ANGLE***	74	74
HA - HEAD TUBE ANGLE***	70	70
CS - CHAINSTAY LENGTH**	460	460
WB - WHEELBASE**	1084	1094
REACH**	385	395
STACK**	610	610
BB DROP**	60	60

* dimension in inches, ** dimension in mm, *** dimension in degrees

EVADO 4.0



SKU	SIZE	COLOUR	FINISH
KREV4Z28X19M003618	M	graphite-red	gloss
KREV4Z28X21M003620	L	graphite-red	gloss
KREV4Z28X23M003622	XL	graphite-red	gloss
KREV4Z28X19M003619	M	black-green	mat
KREV4Z28X21M003621	L	black-green	mat
KREV4Z28X23M003623	XL	black-green	mat

GEAR RATIO 3 x 8

WHEEL DIAMETER 28"

COLOUR VARIANTS



FRAME

FRAME	ALUMINIUM LITE
FORK	SR SUNTOUR NEX
FORK TRAVEL	63 mm
SIZES	M(19"), L(21"), XL(23")

DRIVETRAIN

FRONT DERAILLEUR	SHIMANO TOURNEY TY710
REAR DERAILLEUR	SHIMANO ACERA M360
FRONT BRAKE	SHIMANO ALTUS ST-EF505
REAR BRAKE	SHIMANO MT200
BRAKE LEVERS	SHIMANO ALTUS ST-EF505
BRAKE DISCS	DISC (160 mm)
SHIFTERS	SHIMANO ST-EF505
CRANKSET	ALUMINIUM
SPROCKETS	48T-38T-28T/170 mm
BOTTOM BRACKET	FP-B902
CHAIN	YBN S8
CASSETTE/FREEWHEEL	SHIMANO ALTUS HG31
CASSETTE/FREEWHEEL RANGE	11-32T

WHEELS

FRONT HUB	QR 9 mm
REAR HUB	QR 9 mm
RIMS	KROSS ALUMINIUM 622 x 19
TIRES	WANDA G5001 28 x 1,75

COMPONENTS

HANDLEBAR	ALUMINIUM 640 mm 31.8
HANDLEBAR STEM	ALUMINIUM 105 mm/31,8/7°
SEAT POST	AMORTIZED 31,6 x 350 mm
HEADSET	1-1/8"
SADDLE	SELLE ROYAL SHADOW
GRIPS	HERRMANS OXY
PEDALS	FP-917N

GEOMETRY

SIZE	M	L	XL
FS - FRAME SIZE*	19	21	23
ST - SEAT TUBE LENGTH**	480	530	580
TT - TOP TUBE LENGTH**	570	585	600
HT - HEAD TUBE LENGTH**	140	140	160
SA - SEAT TUBE ANGLE***	74	74	74
HA - HEAD TUBE ANGLE***	70	70	70
CS - CHAINSTAY LENGTH**	460	460	460
WB - WHEELBASE**	1094	1109	1125
REACH**	395	410	420
STACK**	610	610	629
BB DROP**	60	60	60

* dimension in inches, ** dimension in mm, *** dimension in degrees

EVADO 4.0



SKU	SIZE	COLOUR	FINISH
KREV4Z28X17W003614	DM	ruby red-black	gloss
KREV4Z28X19W003616	DL	ruby red-black	gloss
KREV4Z28X17W003615	DM	black-raspberry	gloss
KREV4Z28X19W003617	DL	black-raspberry	gloss

GEAR RATIO 3 x 8

WHEEL DIAMETER 28"

COLOUR VARIANTS



FRAME

FRAME	ALUMINIUM LITE
FORK	SR SUNTOUR NEX
FORK TRAVEL	63 mm
SIZES	DM(17"), DL(19")

DRIVETRAIN

FRONT DERAILLEUR	SHIMANO TOURNEY TY710
REAR DERAILLEUR	SHIMANO ACERA M360
FRONT BRAKE	SHIMANO ALTUS ST-EF505
REAR BRAKE	SHIMANO MT200
BRAKE LEVERS	SHIMANO ALTUS ST-EF505
BRAKE DISCS	DISC (160 mm)
SHIFTERS	SHIMANO ST-EF505
CRANKSET	ALUMINIUM
SPROCKETS	48T-38T-28T/170 mm
BOTTOM BRACKET	FP-B902
CHAIN	YBN S8
CASSETTE/FREEWHEEL	SHIMANO ALTUS HG31
CASSETTE/FREEWHEEL RANGE	11-32T

WHEELS

FRONT HUB	QR 9 mm
REAR HUB	QR 9 mm
RIMS	KROSS ALUMINIUM 622 x 19
TIRES	WANDA G5001 28 x 1,75

COMPONENTS

HANDLEBAR	ALUMINIUM 640 mm 31.8
HANDLEBAR STEM	ALUMINIUM 90 mm/31,8/7°
SEAT POST	AMORTIZED 31,6 x 300 mm
HEADSET	1-1/8"
SADDLE	SELLE ROYAL SHADOW
GRIPS	HERRMANS OXY
PEDALS	FP-917N

GEOMETRY

SIZE	DM	DL
FS - FRAME SIZE*	17	19
ST - SEAT TUBE LENGTH**	430	480
TT - TOP TUBE LENGTH**	560	570
HT - HEAD TUBE LENGTH**	140	140
SA - SEAT TUBE ANGLE***	74	74
HA - HEAD TUBE ANGLE***	70	70
CS - CHAINSTAY LENGTH**	460	460
WB - WHEELBASE**	1084	1094
REACH**	385	395
STACK**	610	610
BB DROP**	60	60

* dimension in inches, ** dimension in mm, *** dimension in degrees

EVADO 4.0



SKU	SIZE	COLOUR	FINISH
KREV4Z28X19M005406	M	graphite-red	gloss
KREV4Z28X21M005407	L	graphite-red	gloss
KREV4Z28X23M005408	XL	graphite-red	gloss
KREV4Z28X19M005409	M	black-green	mat
KREV4Z28X21M005410	L	black-green	mat
KREV4Z28X23M005411	XL	black-green	mat

GEAR RATIO 3 x 8

WHEEL DIAMETER 28"

COLOUR VARIANTS



FRAME

FRAME	ALUMINIUM LITE
FORK	SR SUNTOUR NEX
FORK TRAVEL	63 mm
SIZES	M(19"), L(21"), XL(23")

DRIVETRAIN

FRONT DERAILLEUR	SHIMANO TOURNEY TY510
REAR DERAILLEUR	SHIMANO ACERA M360
FRONT BRAKE	RADIUS SF-891
REAR BRAKE	RADIUS SF-891
BRAKE LEVERS	RADIUS
BRAKE DISCS	DISC (160 mm)
SHIFTERS	RADIUS SF-891
CRANKSET	PROWHEEL TY-CM99
SPROCKETS	48T-38T-28T/170 mm
BOTTOM BRACKET	FP-B902-2S
CHAIN	YBN S8
CASSETTE/FREEWHEEL	SHIMANO ALTUS HG31
CASSETTE/FREEWHEEL RANGE	11-32T

WHEELS

FRONT HUB	QR 9 mm
REAR HUB	QR 9 mm
RIMS	KROSS ALUMINIUM 622 x 19
TIRES	WANDA G5001 28 x 1,75

COMPONENTS

HANDLEBAR	ALUMINIUM 640 mm 31.8
HANDLEBAR STEM	ALUMINIUM 90 mm/31,8/7°
SEAT POST	AMORTIZED 31,6 x 350 mm
HEADSET	1-1/8"
SADDLE	SELLE ROYAL SHADOW
GRIPS	HERRMANS OXY
PEDALS	FP-917N

GEOMETRY

SIZE	M	L	XL
FS - FRAME SIZE*	19	21	23
ST - SEAT TUBE LENGTH**	480	530	580
TT - TOP TUBE LENGTH**	570	585	600
HT - HEAD TUBE LENGTH**	140	140	160
SA - SEAT TUBE ANGLE***	74	74	74
HA - HEAD TUBE ANGLE***	70	70	70
CS - CHAINSTAY LENGTH**	460	460	460
WB - WHEELBASE**	1094	1109	1125
REACH**	395	410	420
STACK**	610	610	629
BB DROP**	60	60	60

* dimension in inches, ** dimension in mm, *** dimension in degrees

EVADO 3.0

NEW



SKU	SIZE	COLOUR	FINISH
KREV3Z28X19M006710	M	navy blue-silver	mat
KREV3Z28X21M006712	L	navy blue-silver	mat
KREV3Z28X23M006714	XL	navy blue-silver	mat
KREV3Z28X19M006711	M	black-orange	gloss
KREV3Z28X21M006713	L	black-orange	gloss
KREV3Z28X23M006715	XL	black-orange	gloss

GEAR RATIO 3 x 8

WHEEL DIAMETER 28"

COLOUR VARIANTS



FRAME

FRAME	ALUMINIUM PERFORMANCE
FORK	SR SUNTOUR NEX
FORK TRAVEL	63 mm
SIZES	M(19"), L(21"), XL(23")

DRIVETRAIN

FRONT DERAILLEUR	SHIMANO TOURNEY TY510
REAR DERAILLEUR	SHIMANO ACERA M360
FRONT BRAKE	MECHANICAL DISC
REAR BRAKE	MECHANICAL DISC
BRAKE LEVERS	SHIMANO ACERA ST-EF500
BRAKE DISCS	DISC (160 mm)
SHIFTERS	SHIMANO ACERA ST-EF500
CRANKSET	PROWHEEL TY-CM99
SPROCKETS	48T-38T-28T/170 mm
BOTTOM BRACKET	FP-B902
CHAIN	YBN S8
CASSETTE/FREEWHEEL	SHIMANO ALTUS HG31
CASSETTE/FREEWHEEL RANGE	11-32T

WHEELS

FRONT HUB	GULI GL-B43F
REAR HUB	GULI GL-B43R
RIMS	KROSS ALUMINIUM 622 x 19
TIRES	WANDA G5001 28 x 1,75

COMPONENTS

HANDLEBAR	ALUMINIUM 640 mm 31.8
HANDLEBAR STEM	ALUMINIUM 75 mm/31,8/7°
SEAT POST	AMORTIZED 31,6 x 350 mm
HEADSET	FP-H816 O1-1/8"
SADDLE	SELLE ROYAL SHADOW
GRIPS	HERMANS OXY DD29BL
PEDALS	FP-917N

GEOMETRY

SIZE	M	L	XL
FS - FRAME SIZE*	19	21	23
ST - SEAT TUBE LENGTH**	480	530	580
TT - TOP TUBE LENGTH**	570	585	600
HT - HEAD TUBE LENGTH**	140	140	160
SA - SEAT TUBE ANGLE***	74	74	74
HA - HEAD TUBE ANGLE***	70	70	70
CS - CHAINSTAY LENGTH**	460	460	460
WB - WHEELBASE**	1094	1109	1125
REACH**	395	410	420
STACK**	610	610	629
BB DROP**	60	60	60

* dimension in inches, ** dimension in mm, *** dimension in degrees

EVADO 3.0



SKU	SIZE	COLOUR	FINISH
KREV3Z28X21M003610	L	navy blue-silver	mat
KREV3Z28X23M003612	XL	navy blue-silver	mat
KREV3Z28X19M003609	M	black-orange	gloss
KREV3Z28X21M003611	L	black-orange	gloss
KREV3Z28X23M003613	XL	black-orange	gloss

GEAR RATIO 3 x 8

WHEEL DIAMETER 28"

COLOUR VARIANTS



FRAME

FRAME	ALUMINIUM PERFORMANCE
FORK	SR SUNTOUR NEX
FORK TRAVEL	63 mm
SIZES	M(19"), L(21"), XL(23")

DRIVETRAIN

FRONT DERAILLEUR	SHIMANO TOURNEY TY710
REAR DERAILLEUR	SHIMANO ACERA M360
FRONT BRAKE	MECHANICAL DISC
REAR BRAKE	MECHANICAL DISC
BRAKE LEVERS	SHIMANO EF500
BRAKE DISCS	DISC (160 mm)
SHIFTERS	SHIMANO EF500
CRANKSET	ALUMINIUM
SPROCKETS	48T-38T-28T/170 mm
BOTTOM BRACKET	FP-B902
CHAIN	SHIMANO HG40
CASSETTE/FREEWHEEL	SHIMANO HG200
CASSETTE/FREEWHEEL RANGE	12-32T

WHEELS

FRONT HUB	QR 9 mm
REAR HUB	QR 9 mm
RIMS	KROSS
TIRES	WANDA G5001 28 x 1,75

COMPONENTS

HANDLEBAR	ALUMINIUM 640 mm 31.8
HANDLEBAR STEM	ALUMINIUM 105 mm/31,8/7°
SEAT POST	AMORTIZED 31,6 x 350 mm
HEADSET	1-1/8"
SADDLE	SELLE ROYAL SHADOW
GRIPS	HERRMANS OXY
PEDALS	FP-917N

GEOMETRY

SIZE	M	L	XL
FS - FRAME SIZE*	19	21	23
ST - SEAT TUBE LENGTH**	480	530	580
TT - TOP TUBE LENGTH**	570	585	600
HT - HEAD TUBE LENGTH**	140	140	160
SA - SEAT TUBE ANGLE***	74	74	74
HA - HEAD TUBE ANGLE***	70	70	70
CS - CHAINSTAY LENGTH**	460	460	460
WB - WHEELBASE**	1094	1109	1125
REACH**	395	410	420
STACK**	610	610	629
BB DROP**	60	60	60

* dimension in inches, ** dimension in mm, *** dimension in degrees

EVADO 3.0

NEW



SKU	SIZE	COLOUR	FINISH
KREV3Z28X17W003604	DM	white-steel	gloss
KREV3Z28X19W003606	DL	white-steel	gloss
KREV3Z28X17W006706	DM	white-steel	gloss
KREV3Z28X19W006708	DL	white-steel	gloss
KREV3Z28X17W006707	DM	turquoise-silver	gloss
KREV3Z28X19W006709	DL	turquoise-silver	gloss

GEAR RATIO 3 x 8

WHEEL DIAMETER 28"

COLOUR VARIANTS



FRAME

FRAME	ALUMINIUM PERFORMANCE
FORK	SR SUNTOUR NEX
FORK TRAVEL	63 mm
SIZES	DM(17"), DL(19")

DRIVETRAIN

FRONT DERAILLEUR	SHIMANO TOURNEY TY710
REAR DERAILLEUR	SHIMANO ACERA M360
FRONT BRAKE	MECHANICAL DISC
REAR BRAKE	MECHANICAL DISC
BRAKE LEVERS	SHIMANO ACERA ST-EF500
BRAKE DISCS	DISC (160 mm)
SHIFTERS	SHIMANO EF500
CRANKSET	ALUMINIUM
SPROCKETS	48T-38T-28T/170 mm
BOTTOM BRACKET	FP-B902
CHAIN	YBN S8
CASSETTE/FREEWHEEL	SHIMANO ALTUS HG31
CASSETTE/FREEWHEEL RANGE	11-32T

WHEELS

FRONT HUB	QR 9 mm
REAR HUB	QR 9 mm
RIMS	KROSS ALUMINIUM 622 x 19
TIRES	WANDA G5001 28 x 1,75

COMPONENTS

HANDLEBAR	ALUMINIUM 640 mm 31,8
HANDLEBAR STEM	ALUMINIUM 90 mm/31,8/7°
SEAT POST	AMORTIZED 31,6 x 300 mm
HEADSET	1-1/8"
SADDLE	SELLE ROYAL SHADOW
GRIPS	HERRMANS OXY
PEDALS	FP-917N

GEOMETRY

SIZE	DM	DL
FS - FRAME SIZE*	17	19
ST - SEAT TUBE LENGTH**	430	480
TT - TOP TUBE LENGTH**	560	570
HT - HEAD TUBE LENGTH**	140	140
SA - SEAT TUBE ANGLE***	74	74
HA - HEAD TUBE ANGLE***	70	70
CS - CHAINSTAY LENGTH**	460	460
WB - WHEELBASE**	1084	1094
REACH**	385	395
STACK**	610	610
BB DROP**	60	60

* dimension in inches, ** dimension in mm, *** dimension in degrees

EVADO 2.0

NEW



SKU	SIZE	COLOUR	FINISH
KREV2Z28X19M006702	M	black-blue	gloss
KREV2Z28X21M006704	L	black-blue	gloss
KREV2Z28X19M006703	M	black-green	mat
KREV2Z28X21M006705	L	black-green	mat

GEAR RATIO 3 x 7

WHEEL DIAMETER 28"

COLOUR VARIANTS



FRAME

FRAME	ALUMINIUM PERFORMANCE
FORK	HL CORP 120E
FORK TRAVEL	30 mm
SIZES	M(19"), L(21")

DRIVETRAIN

FRONT DERAILLEUR	SHIMANO TOURNEY TY510
REAR DERAILLEUR	SHIMANO ALTUS M310
FRONT BRAKE	V-BRAKE
REAR BRAKE	V-BRAKE
BRAKE LEVERS	SHIMANO TOURNEY ST-EF41
SHIFTERS	SHIMANO TOURNEY ST-EF41
CRANKSET	WHEEL TOP TCRF2-CFPF
SPROCKETS	48T-38T-28T/170 mm
BOTTOM BRACKET	FP-B902
CHAIN	KMC HV500
CASSETTE/FREEWHEEL	SHIMANO TOURNEY MF-TZ500
CASSETTE/FREEWHEEL RANGE	14-28T

WHEELS

FRONT HUB	GULI GL-B01F
REAR HUB	GULI GL-B01R
RIMS	KROSS ALUMINIUM 622 x 19
TIRES	WANDA G5001 28 x 1,75

COMPONENTS

HANDLEBAR	ALUMINIUM 640 mm 31,8
HANDLEBAR STEM	ALUMINIUM 90 mm/31,8/7°
SEAT POST	ALUMINIUM 27,2 x 350 mm
HEADSET	FP-H863 O1-1/8"
SADDLE	SELLE ROYAL SHADOW
GRIPS	HERMANS OXY DD29BL
PEDALS	FP-804

GEOMETRY

SIZE	M	L
FS - FRAME SIZE*	19	21
ST - SEAT TUBE LENGTH**	480	530
TT - TOP TUBE LENGTH**	570	585
HT - HEAD TUBE LENGTH**	140	140
SA - SEAT TUBE ANGLE***	74	74
HA - HEAD TUBE ANGLE***	70	70
CS - CHAINSTAY LENGTH**	460	460
WB - WHEELBASE**	1094	1109
REACH**	395	410
STACK**	610	610
BB DROP**	60	60

* dimension in inches, ** dimension in mm, *** dimension in degrees

EVADO 2.0

NEW



SKU	SIZE	COLOUR	FINISH
KREV2Z28X15W006696	DS	black-mint	gloss
KREV2Z28X17W006698	DM	black-mint	gloss
KREV2Z28X19W006700	DL	black-mint	gloss
KREV2Z28X15W006697	DS	graphite-black	mat
KREV2Z28X17W006699	DM	graphite-black	mat
KREV2Z28X19W006701	DL	graphite-black	mat

GEAR RATIO 3 x 7

WHEEL DIAMETER 28"

COLOUR VARIANTS



FRAME

FRAME	ALUMINIUM 6061
FORK	HL CORP 120E
FORK TRAVEL	30 mm
SIZES	DS(15"), DM(17"), DL(19")

DRIVETRAIN

FRONT DERAILLEUR	SHIMANO TOURNEY TY510
REAR DERAILLEUR	SHIMANO ALTUS M310
FRONT BRAKE	V-BRAKE
REAR BRAKE	V-BRAKE
BRAKE LEVERS	SHIMANO TOURNEY ST-EF41
SHIFTERS	SHIMANO TOURNEY ST-EF41
CRANKSET	WHEEL TOP TCRF2-CFPF
SPROCKETS	48T-38T-28T/170 mm
BOTTOM BRACKET	FP-B902
CHAIN	KMC HV500
CASSETTE/FREEWHEEL	SHIMANO TOURNEY MF-TZ500
CASSETTE/FREEWHEEL RANGE	14-28T

WHEELS

FRONT HUB	GULI GL-B01F
REAR HUB	GULI GL-B01R
RIMS	KROSS ALUMINIUM 622 x 19
TIRES	WANDA G5001 28 x 1,75

COMPONENTS

HANDLEBAR	ALUMINIUM 640 mm 31,8
HANDLEBAR STEM	ALUMINIUM 75 mm/31,8/7°
SEAT POST	ALUMINIUM 27,2 x 300 mm
HEADSET	FP-H863 O1-1/8"
SADDLE	SELLE ROYAL SHADOW
GRIPS	HERMANS OXY DD29BL
PEDALS	FP-804

GEOMETRY

SIZE	DS	DM	DL
FS - FRAME SIZE*	15	17	19
ST - SEAT TUBE LENGTH**	380	430	480
TT - TOP TUBE LENGTH**	550	560	570
HT - HEAD TUBE LENGTH**	140	140	140
SA - SEAT TUBE ANGLE***	74	74	74
HA - HEAD TUBE ANGLE***	70	70	70
CS - CHAINSTAY LENGTH**	460	460	460
WB - WHEELBASE**	1074	1084	1094
REACH**	375	385	395
STACK**	610	610	610
BB DROP**	60	60	60

* dimension in inches, ** dimension in mm, *** dimension in degrees

EVADO 2.0



SKU	SIZE	COLOUR	FINISH
KREV2Z28X19M004340	M	black-blue	gloss
KREV2Z28X21M004341	L	black-blue	gloss
KREV2Z28X19M004342	M	black-green	mat
KREV2Z28X21M004343	L	black-green	mat

GEAR RATIO 3 x 7

WHEEL DIAMETER 28"

COLOUR VARIANTS



FRAME

FRAME	ALUMINIUM PERFORMANCE
FORK	SR SUNTOUR M3010
FORK TRAVEL	50 mm
SIZES	M(19"), L(21")

DRIVETRAIN

FRONT DERAILLEUR	SHIMANO TOURNEY TY510
REAR DERAILLEUR	SHIMANO ALTUS M310
FRONT BRAKE	V-BRAKE
REAR BRAKE	V-BRAKE
BRAKE LEVERS	SHIMANO TOURNEY ST-EF41
SHIFTERS	SHIMANO EF41
CRANKSET	LANXI
SPROCKETS	48T-38T-28T/170 mm
BOTTOM BRACKET	FP-B902
CHAIN	KMC HV500
CASSETTE/FREEWHEEL	SHIMANO TOURNEY MF-TZ500
CASSETTE/FREEWHEEL RANGE	14-28T

WHEELS

FRONT HUB	GL-B01F-QR
REAR HUB	GL-B01R-QR
RIMS	KROSS ALUMINIUM 622 x 19
TIRES	WANDA G5001 28 x 1,75

COMPONENTS

HANDLEBAR	ALUMINIUM 640 mm 31,8
HANDLEBAR STEM	ALUMINIUM 90 mm/31,8/7°
SEAT POST	ALUMINIUM 27,2 x 350 mm
HEADSET	FP-H863 O1-1/8"
SADDLE	SELLE ROYAL SHADOW
GRIPS	HERRMANS OXY
PEDALS	FP-804

GEOMETRY

SIZE	M	L
FS - FRAME SIZE*	19	21
ST - SEAT TUBE LENGTH**	480	530
TT - TOP TUBE LENGTH**	570	585
HT - HEAD TUBE LENGTH**	140	140
SA - SEAT TUBE ANGLE***	74	74
HA - HEAD TUBE ANGLE***	70	70
CS - CHAINSTAY LENGTH**	460	460
WB - WHEELBASE**	1094	1109
REACH**	395	410
STACK**	610	610
BB DROP**	60	60

* dimension in inches, ** dimension in mm, *** dimension in degrees

EVADO 2.0



SKU	SIZE	COLOUR	FINISH
KREV2Z28X15W004334	DS	black-mint	gloss
KREV2Z28X17W004335	DM	black-mint	gloss
KREV2Z28X19W004336	DL	black-mint	gloss
KREV2Z28X15W004337	DS	graphite-black	mat
KREV2Z28X17W004338	DM	graphite-black	mat
KREV2Z28X19W004339	DL	graphite-black	mat

GEAR RATIO 3 x 7

WHEEL DIAMETER 28"

COLOUR VARIANTS



FRAME

FRAME	ALUMINIUM PERFORMANCE
FORK	SR SUNTOUR M3010
FORK TRAVEL	50 mm
SIZES	DS(15"), DM(17"), DL(19")

DRIVETRAIN

FRONT DERAILLEUR	SHIMANO TOURNEY TY510
REAR DERAILLEUR	SHIMANO ALTUS M310
FRONT BRAKE	V-BRAKE
REAR BRAKE	V-BRAKE
BRAKE LEVERS	SHIMANO TOURNEY ST-EF41
SHIFTERS	SHIMANO EF41
CRANKSET	LANXI
SPROCKETS	48T-38T-28T/170 mm
BOTTOM BRACKET	FP-B902
CHAIN	KMC HV500
CASSETTE/FREEWHEEL	SHIMANO TOURNEY MF-TZ500
CASSETTE/FREEWHEEL RANGE	14-28T

WHEELS

FRONT HUB	GL-B01F-QR
REAR HUB	GL-B01R-QR
RIMS	KROSS ALUMINIUM 622 x 19
TIRES	WANDA G5001 28 x 1,75

COMPONENTS

HANDLEBAR	ALUMINIUM 640 mm 31.8
HANDLEBAR STEM	ALUMINIUM 75 mm/31,8/7°
SEAT POST	ALUMINIUM 27,2 x 300 mm
HEADSET	FP-H863 O1-1/8"
SADDLE	SELLE ROYAL SHADOW
GRIPS	HERRMANS OXY
PEDALS	FP-804

GEOMETRY

SIZE	DS	DM	DL
FS - FRAME SIZE*	15	17	19
ST - SEAT TUBE LENGTH**	380	430	480
TT - TOP TUBE LENGTH**	550	560	570
HT - HEAD TUBE LENGTH**	140	140	140
SA - SEAT TUBE ANGLE***	74	74	74
HA - HEAD TUBE ANGLE***	70	70	70
CS - CHAINSTAY LENGTH**	460	460	460
WB - WHEELBASE**	1074	1084	1094
REACH**	375	385	395
STACK**	610	610	610
BB DROP**	60	60	60

* dimension in inches, ** dimension in mm, *** dimension in degrees

EVADO 1.0



SKU	SIZE	COLOUR	FINISH
KREV1Z28X19M004330	M	black-graphite	mat
KREV1Z28X21M004331	L	black-graphite	mat
KREV1Z28X19M004332	M	graphite-red	mat
KREV1Z28X21M004333	L	graphite-red	mat

GEAR RATIO 3 x 7

WHEEL DIAMETER 28"

COLOUR VARIANTS



FRAME

FRAME	ALUMINIUM LITE
FORK	HL CORP 120E
FORK TRAVEL	30 mm
SIZES	M(19"), L(21")

DRIVETRAIN

FRONT DERAILLEUR	SHIMANO TOURNEY TY510
REAR DERAILLEUR	SHIMANO TOURNEY TY300
FRONT BRAKE	V-BRAKE
REAR BRAKE	V-BRAKE
BRAKE LEVERS	ALUMINIUM
SHIFTERS	SHIMANO SL-RS36
CRANKSET	LANXI
SPROCKETS	48-28T/170 mm
BOTTOM BRACKET	FP-B902
CHAIN	KMC HV500
CASSETTE/FREEWHEEL	SHIMANO TOURNEY MF-TZ500
CASSETTE/FREEWHEEL RANGE	14-28T

WHEELS

FRONT HUB	GL-B01F-QR
REAR HUB	GL-B01R-QR
RIMS	KROSS ALUMINIUM 622 x 19
TIRES	WANDA G5001 28 x 1,75

COMPONENTS

HANDLEBAR	ALUMINIUM 640 mm 31.8
HANDLEBAR STEM	ALUMINIUM 75 mm/31,8/7°
SEAT POST	ALUMINIUM 27,2 x 350 mm
HEADSET	FP-H863 O1-1/8"
SADDLE	SELLE ROYAL SHADOW
GRIPS	HERRMANS
PEDALS	FP-804

GEOMETRY

SIZE	M	L
FS - FRAME SIZE*	19	21
ST - SEAT TUBE LENGTH**	480	530
TT - TOP TUBE LENGTH**	570	585
HT - HEAD TUBE LENGTH**	140	140
SA - SEAT TUBE ANGLE***	74	74
HA - HEAD TUBE ANGLE***	70	70
CS - CHAINSTAY LENGTH**	460	460
WB - WHEELBASE**	1094	1109
REACH**	395	410
STACK**	610	610
BB DROP**	60	60

* dimension in inches, ** dimension in mm, *** dimension in degrees

EVADO 1.0



SKU	SIZE	COLOUR	FINISH
KREV1Z28X15W004324	DS	white-turquoise	gloss
KREV1Z28X17W004325	DM	white-turquoise	gloss
KREV1Z28X19W004326	DL	white-turquoise	gloss
KREV1Z28X15W004327	DS	graphite-raspberry	mat
KREV1Z28X17W004328	DM	graphite-raspberry	mat
KREV1Z28X19W004329	DL	graphite-raspberry	mat

GEAR RATIO 3 x 7

WHEEL DIAMETER 28"

COLOUR VARIANTS



FRAME

FRAME	ALUMINIUM LITE
FORK	HL CORP 120E
FORK TRAVEL	30 mm
SIZES	DS(15"), DM(17"), DL(19")

DRIVETRAIN

FRONT DERAILLEUR	SHIMANO TOURNEY TY510
REAR DERAILLEUR	SHIMANO TOURNEY TY300
FRONT BRAKE	V-BRAKE
REAR BRAKE	V-BRAKE
BRAKE LEVERS	ALUMINIUM
SHIFTERS	SHIMANO SL-RS36
CRANKSET	LANXI
SPROCKETS	48-28T/170 mm
BOTTOM BRACKET	FP-B902
CHAIN	KMC HV500
CASSETTE/FREEWHEEL	SHIMANO TOURNEY MF-TZ500
CASSETTE/FREEWHEEL RANGE	14-28T

WHEELS

FRONT HUB	GL-B01F-QR
REAR HUB	GL-B01R-QR
RIMS	KROSS ALUMINIUM 622 x 19
TIRES	WANDA G5001 28 x 1,75

COMPONENTS

HANDLEBAR	ALUMINIUM 640 mm 31.8
HANDLEBAR STEM	ALUMINIUM 75 mm/31,8/7°
SEAT POST	ALUMINIUM 27,2 x 300 mm
HEADSET	FP-H863 01-1/8"
SADDLE	SELLE ROYAL SHADOW
GRIPS	HERRMANS
PEDALS	FP-804

GEOMETRY

SIZE	DS	DM	DL
FS - FRAME SIZE*	15	17	19
ST - SEAT TUBE LENGTH**	380	430	480
TT - TOP TUBE LENGTH**	550	560	570
HT - HEAD TUBE LENGTH**	140	140	140
SA - SEAT TUBE ANGLE***	74	74	74
HA - HEAD TUBE ANGLE***	70	70	70
CS - CHAINSTAY LENGTH**	460	460	460
WB - WHEELBASE**	1074	1084	1094
REACH**	375	385	395
STACK**	610	610	610
BB DROP**	60	60	60

* dimension in inches, ** dimension in mm, *** dimension in degrees

CITY BIKES

CITY

The City line is the perfect choice for those looking for a comfortable, enjoyable and stylish bike for daily commutes, trips to the parks or leisure rides around the neighbourhood.

It features a comfortable geometry, which means a more upright riding position and a lower top tube for easier mounting. This provides comfort during the ride, minimises spinal strain, and enhances visibility while riding, thereby improving safety.

Bikes from the City line are designed for urban environments with dedicated components such as derailleurs and brakes that ensure reliability and ease of use.





SENTIO 4.0



SKU	SIZE	COLOUR	FINISH
KRST4Z28X18U004386	S	khaki-brown	gloss
KRST4Z28X20U004387	M	khaki-brown	gloss
KRST4Z28X18U004384	S	rose gold-white	gloss
KRST4Z28X20U004385	M	rose gold-white	gloss

GEAR RATIO 3 x 9

WHEEL DIAMETER 28"

COLOUR VARIANTS



FRAME

FRAME	ALUMINIUM 6061
FORK	SR SUNTOUR NEX HLO
FORK TRAVEL	50 mm
SIZES	S(18"), M(20")

DRIVETRAIN

FRONT DERAILLEUR	SHIMANO ALTUS M370
REAR DERAILLEUR	SHIMANO ACERA T3000
FRONT BRAKE	SHIMANO MT200
REAR BRAKE	SHIMANO MT200
BRAKE LEVERS	SHIMANO MT201
BRAKE DISCS	SHIMANO RT10 160 CL
SHIFTERS	SHIMANO ALTUS M2010
CRANKSET	SHIMANO FC-T3010
SPROCKETS	48T-36T-26T/170 mm
BOTTOM BRACKET	FP-B902
CHAIN	SHIMANO HG53
CASSETTE/FREEWHEEL	SHIMANO ALTUS HG200
CASSETTE/FREEWHEEL RANGE	11-32T

WHEELS

FRONT HUB	SHIMANO NEXUS DH-3D37
REAR HUB	SHIMANO TOURNEY TX505
RIMS	KROSS ALUMINIUM 622 x 19
TIRES	WANDA P1024 28 x 1,5

COMPONENTS

HANDLEBAR	ALUMINIUM 660 mm 31,8
HANDLEBAR STEM	ALUMINIUM 90 mm/31,8 REG
SEAT POST	AMORTIZED 31,6 x 350 mm
HEADSET	FP-H863 01-1/8"
SADDLE	SELLE ROYAL LOOKIN RVS MOD W
GRIPS	PROPALM GRIPPEN
PEDALS	FP-210ZU
CARRIER	STANDWELL ALUMINIUM 28" 25 kg
FRONT LIGHT	AXA ECHO DYNAMO/EBIKE
REAR LIGHT	AXA X-RAY
MUDGUARDS	TUBUS TW. SZT. 28"
KICK STAND	URSUS REAR "KING"

GEOMETRY

SIZE	S	M
FS - FRAME SIZE*	18	20
ST - SEAT TUBE LENGTH**	457	508
TT - TOP TUBE LENGTH**	580	580
HT - HEAD TUBE LENGTH**	150	160
SA - SEAT TUBE ANGLE***	74	74
HA - HEAD TUBE ANGLE***	70	70
CS - CHAINSTAY LENGTH**	460	460
WB - WHEELBASE**	1085	1105
REACH**	382	400
STACK**	620	629
BB DROP**	60	60

* dimension in inches, ** dimension in mm, *** dimension in degrees

SENTIO 3.0



SKU	SIZE	COLOUR	FINISH
KRST3Z28X18U004382	S	black-graphite	gloss
KRST3Z28X20U004383	M	black-graphite	gloss
KRST3Z28X18U004380	S	yellow-black	gloss
KRST3Z28X20U004381	M	yellow-black	gloss

GEAR RATIO 3 x 8

WHEEL DIAMETER 28"

COLOUR VARIANTS



FRAME

FRAME	ALUMINIUM 6061
FORK	SR SUNTOUR NEX
FORK TRAVEL	50 mm
SIZES	S(18"), M(20")

DRIVETRAIN

FRONT DERAILLEUR	SHIMANO TOURNEY TY710
REAR DERAILLEUR	SHIMANO ACERA M360
FRONT BRAKE	MECHANICAL DISC
REAR BRAKE	MECHANICAL DISC
BRAKE LEVERS	SHIMANO ACERA ST-EF500
BRAKE DISCS	DISC (160 mm)
SHIFTERS	SHIMANO ACERA ST-EF500
CRANKSET	PROWHEEL TY-CM99
SPROCKETS	48T-38T-28T/170 mm
BOTTOM BRACKET	FP-B902
CHAIN	KMC HV700
CASSETTE/FREEWHEEL	SHIMANO TURNEY HG200
CASSETTE/FREEWHEEL RANGE	12-32T

WHEELS

FRONT HUB	GULI GL-B43F
REAR HUB	GULI GL-B43R
RIMS	KROSS ALUMINIUM 622 x 19
TIRES	WANDA P1024 28 x 1,5

COMPONENTS

HANDLEBAR	ALUMINIUM 660 mm 31,8
HANDLEBAR STEM	ALUMINIUM 90 mm/31,8 REG
SEAT POST	AMORTIZED 31,6 x 350 mm
HEADSET	FP-H863 O1-1/8"
SADDLE	SV353
GRIPS	PROPALM GRIPPEN
PEDALS	FP-804
CARRIER	STANDWELL ALUMINIUM 28" 25 kg
FRONT LIGHT	HERRMANS H-IKE BATTERY
REAR LIGHT	BUCHER TIVOLI BATTERY
MUDGUARDS	TUBUS TW. SZT. 28"
KICK STAND	URSUS BASIC

GEOMETRY

SIZE	S	M
FS - FRAME SIZE*	18	20
ST - SEAT TUBE LENGTH**	457	508
TT - TOP TUBE LENGTH**	580	580
HT - HEAD TUBE LENGTH**	150	160
SA - SEAT TUBE ANGLE***	74	74
HA - HEAD TUBE ANGLE***	70	70
CS - CHAINSTAY LENGTH**	460	460
WB - WHEELBASE**	1085	1105
REACH**	382	400
STACK**	620	629
BB DROP**	60	60

* dimension in inches, ** dimension in mm, *** dimension in degrees

SENTIO 2.0



SKU	SIZE	COLOUR	FINISH
KRST2Z28X18U004378	S	blue-gray	gloss
KRST2Z28X20U004379	M	blue-gray	gloss
KRST2Z28X18U004376	S	turquoise-gray	gloss
KRST2Z28X20U004377	M	turquoise-gray	gloss

GEAR RATIO 3 x 7

WHEEL DIAMETER 28"

COLOUR VARIANTS



FRAME

FRAME	ALUMINIUM
FORK	SR SUNTOUR M3010
FORK TRAVEL	50 mm
SIZES	S(18"), M(20")

DRIVETRAIN

FRONT DERAILLEUR	SHIMANO TOURNEY TY510
REAR DERAILLEUR	SHIMANO ALTUS M310
FRONT BRAKE	V-BRAKE
REAR BRAKE	V-BRAKE
BRAKE LEVERS	ALUMINIUM
SHIFTERS	SHIMANO RS36 REVOSHIFT
CRANKSET	PROWHEEL TY-CM99
SPROCKETS	48T-38T-28T/ 170 mm
BOTTOM BRACKET	FP-B902
CHAIN	YBN S50
CASSETTE/FREEWHEEL	SHIMANO TOURNEY MF-TZ500
CASSETTE/FREEWHEEL RANGE	14-28T

WHEELS

FRONT HUB	GL-B01F
REAR HUB	GL-B01R
RIMS	KROSS ALUMINIUM 622 x 19
TIRES	WANDA P1024 28 x 1,5

COMPONENTS

HANDLEBAR	STEEL 610 mm 25.4
HANDLEBAR STEM	ALUMINIUM 90/25,4 REG
SEAT POST	AMORTIZED 27,2 x 350 mm
HEADSET	FP-H815 O1-1/8"
SADDLE	SV353
GRIPS	HERRMANS
PEDALS	FP-804
CARRIER	BUCHEL ALUMINIUM 28" 25 kg
FRONT LIGHT	BUCHEL OCEAN BATTERY
REAR LIGHT	BUCHEL TIVOLI BATTERY
MUDGUARDS	SIMPLA
KICK STAND	CENTRAL

GEOMETRY

SIZE	S	M
FS - FRAME SIZE*	18	20
ST - SEAT TUBE LENGTH**	460	510
TT - TOP TUBE LENGTH**	560	580
HT - HEAD TUBE LENGTH**	150	160
SA - SEAT TUBE ANGLE***	74	74
HA - HEAD TUBE ANGLE***	70	70
CS - CHAINSTAY LENGTH**	460	460
WB - WHEELBASE**	1085	1105
REACH**	382	400
STACK**	620	629
BB DROP**	60	60

* dimension in inches, ** dimension in mm, *** dimension in degrees

SENTIO 1.0



SKU	SIZE	COLOUR	FINISH
KRST1Z28X18U004372	S	ruby red-gray	gloss
KRST1Z28X20U004373	M	ruby red-gray	gloss

GEAR RATIO 1 x 6

WHEEL DIAMETER 28"

COLOUR VARIANTS



FRAME

FRAME	ALUMINIUM
FORK	HL CORP 120E
FORK TRAVEL	30 mm
SIZES	S(18"), M(20")

DRIVETRAIN

REAR DERAILLEUR	SHIMANO TOURNEY TZ500
FRONT BRAKE	V-BRAKE
REAR BRAKE	V-BRAKE
BRAKE LEVERS	ALUMINIUM
SHIFTERS	SHIMANO TOURNEY REVOSHIFT RS36
CRANKSET	WHEEL TOP SIC2F6P-MZ
SPROCKETS	38T/170 mm
BOTTOM BRACKET	FP-B902
CHAIN	YBN S50
CASSETTE/FREEWHEEL	SHIMANO TOURNEY MF-TZ500
CASSETTE/FREEWHEEL RANGE	14-28T

WHEELS

FRONT HUB	GULI GL-B01F
REAR HUB	GULI GL-B01R
RIMS	KROSS ALUMINIUM 622 x 19
TIRES	WANDA P1024 28 x 1,5

COMPONENTS

HANDLEBAR	STEEL 610 mm 25.4
HANDLEBAR STEM	ALUMINIUM 110/25,4 REG
SEAT POST	ALUMINIUM 27,2 x 350 mm
HEADSET	FP-H815 O1-1/8"
SADDLE	SV353
GRIPS	HERRMANS
PEDALS	FP-804
CARRIER	BUCHEL ALUMINIUM 28" 25 kg
FRONT LIGHT	BUCHEL OCEAN BATTERY
REAR LIGHT	BUCHEL TIVOLI BATTERY
MUDGUARDS	TUBUS TW. SZT. 28"
KICK STAND	URSUS BASIC

GEOMETRY

SIZE	S	M
FS - FRAME SIZE*	18	20
ST - SEAT TUBE LENGTH**	460	510
TT - TOP TUBE LENGTH**	560	580
HT - HEAD TUBE LENGTH**	150	160
SA - SEAT TUBE ANGLE***	74	74
HA - HEAD TUBE ANGLE***	70	70
CS - CHAINSTAY LENGTH**	460	460
WB - WHEELBASE**	1085	1105
REACH**	382	400
STACK**	620	629
BB DROP**	60	60

* dimension in inches, ** dimension in mm, *** dimension in degrees

SENTIO 1.0



GEAR RATIO 1 x 6

WHEEL DIAMETER 28"

COLOUR VARIANTS



SKU	SIZE	COLOUR	FINISH
KRST1Z28X18U004374	S	graphite-gray	gloss
KRST1Z28X20U004375	M	graphite-gray	gloss

FRAME

FRAME	ALUMINIUM PERFORMANCE
FORK	HL CORP 120E
FORK TRAVEL	30 mm
SIZES	S(18"), M(20")

DRIVETRAIN

REAR DERAILLEUR	SHIMANO TOURNEY TZ500
FRONT BRAKE	V-BRAKE
REAR BRAKE	V-BRAKE
BRAKE LEVERS	ALUMINIUM
SHIFTERS	SHIMANO RS36 REVOSHIFT
CRANKSET	LANXI
SPROCKETS	38T/170 mm
BOTTOM BRACKET	FP-B902
CHAIN	YBN S50
CASSETTE/FREEWHEEL	SHIMANO TOURNEY MF-TZ500
CASSETTE/FREEWHEEL RANGE	14-28T

WHEELS

FRONT HUB	GL-B01F
REAR HUB	GL-B01R
RIMS	KROSS ALUMINIUM 622 x 19
TIRES	WANDA P1024 28 x 1,5

COMPONENTS

HANDLEBAR	STEEL 610 mm 25.4
HANDLEBAR STEM	ALUMINIUM 90/25,4 REG
SEAT POST	ALUMINIUM 27,2 x 350 mm
HEADSET	FP-H815 O1-1/8"
SADDLE	SV353
GRIPS	HERRMANS
PEDALS	FP-804
CARRIER	BUCHEL ALUMINIUM 28" 25 kg
FRONT LIGHT	BUCHEL OCEAN BATTERY
REAR LIGHT	BUCHEL TIVOLI BATTERY
MUDGUARDS	SIMPLA
KICK STAND	URSUS

GEOMETRY

SIZE	S	M
FS - FRAME SIZE*	18	20
ST - SEAT TUBE LENGTH**	460	510
TT - TOP TUBE LENGTH**	560	580
HT - HEAD TUBE LENGTH**	150	160
SA - SEAT TUBE ANGLE***	74	74
HA - HEAD TUBE ANGLE***	70	70
CS - CHAINSTAY LENGTH**	460	460
WB - WHEELBASE**	1085	1105
REACH**	382	400
STACK**	620	629
BB DROP**	60	60

* dimension in inches, ** dimension in mm, *** dimension in degrees

LILLE 3.0



SKU	SIZE	COLOUR	FINISH
LGLIZ326X15W006322	DS	grey-celadon	gloss
LGLIZ326X17W006323	DM	grey-celadon	gloss
LGLIZ326X15W006320	DS	green-beige	gloss
LGLIZ326X17W006321	DM	green-beige	gloss

GEAR RATIO 1 x 3

WHEEL DIAMETER 26"

COLOUR VARIANTS



FRAME

FRAME	ALUMINIUM
FORK	STAL
SIZES	DS(15"), DM(17")

DRIVETRAIN

REAR DERAILLEUR	SHIMANO NEXUS
FRONT BRAKE	V-BRAKE
REAR BRAKE	V-BRAKE
BRAKE LEVERS	ALUMINIUM
SHIFTERS	SHIMANO NEXUS
CRANKSET	CYCLONE
SPROCKETS	38T/170 mm
BOTTOM BRACKET	FP-B902
CHAIN	KMC HV410
CASSETTE/FREEWHEEL	SHIMANO
CASSETTE/FREEWHEEL RANGE	19T

WHEELS

FRONT HUB	ALUMINIUM
REAR HUB	SHIMANO NEXUS NEXUS SG-3R40
RIMS	KROSS ALUMINIUM 559 x 19
TIRES	WANDA G5017 26 x 1,75

COMPONENTS

HANDLEBAR	STEEL 610 mm 25.4
HANDLEBAR STEM	ALUMINIUM 110/25,4 REG
SEAT POST	ALUMINIUM 27,2 x 350 mm
HEADSET	FP-H815 O1-1/8"
SADDLE	VELO VL-6049
GRIPS	SYNTHETIC LEATHER
PEDALS	FP-833
CARRIER	INTEGRATED
FRONT LIGHT	REFLECTION
REAR LIGHT	REFLECTION
MUDGUARDS	KROSS
KICK STAND	KROSS

GEOMETRY

SIZE	DS	DM
FS - FRAME SIZE*	15	17
ST - SEAT TUBE LENGTH**	380	430
TT - TOP TUBE LENGTH**	550	565
HT - HEAD TUBE LENGTH**	150	150
SA - SEAT TUBE ANGLE***	73	73
HA - HEAD TUBE ANGLE***	69	69
CS - CHAINSTAY LENGTH**	440	440
WB - WHEELBASE**	1058	1073
REACH**	383	398
STACK**	547	547
BB DROP**	40	40

* dimension in inches, ** dimension in mm, *** dimension in degrees

LILLE 2.0



SKU	SIZE	COLOUR	FINISH
LGLIZ228X17W006316	DM	pink-gray	gloss
LGLIZ228X19W006317	DL	pink-gray	gloss
LGLIZ228X17W006318	DM	emerald-pink	gloss
LGLIZ228X19W006319	DL	emerald-pink	gloss

GEAR RATIO 1 x 6

WHEEL DIAMETER 28"

COLOUR VARIANTS



FRAME

FRAME	ALUMINIUM
FORK	STAL
SIZES	DM(17"), DL(19")

DRIVETRAIN

REAR DERAILLEUR	SHIMANO TOURNEY TZ500
FRONT BRAKE	V-BRAKE
REAR BRAKE	V-BRAKE
BRAKE LEVERS	ALUMINIUM
SHIFTERS	SHIMANO RS36 REVOSHIFT
CRANKSET	CYCLONE
SPROCKETS	38T/170 mm
BOTTOM BRACKET	FP-B902
CHAIN	YBN Z33
CASSETTE/FREEWHEEL	SHIMANO TOURNEY MF-TZ500
CASSETTE/FREEWHEEL RANGE	14-28T

WHEELS

FRONT HUB	ALUMINIUM
REAR HUB	ALUMINIUM
RIMS	KROSS ALUMINIUM 622 x 19
TIRES	WANDA G5001 28 x 1,75

COMPONENTS

HANDLEBAR	STEEL 610 mm 25.4
HANDLEBAR STEM	STEEL 40 mm/25,4/30°
SEAT POST	STEEL 27,2 x 300
HEADSET	FP-H815 O1-1/8"
SADDLE	DDK D226K
GRIPS	SYNTHETIC LEATHER
PEDALS	FP-804
CARRIER	INTEGRATED
FRONT LIGHT	REFLECTION
REAR LIGHT	REFLECTION
MUDGUARDS	KROSS
KICK STAND	KROSS

GEOMETRY

SIZE	DM	DL
FS - FRAME SIZE*	17	19
ST - SEAT TUBE LENGTH**	430	480
TT - TOP TUBE LENGTH**	600	617
HT - HEAD TUBE LENGTH**	150	160
SA - SEAT TUBE ANGLE***	71	71
HA - HEAD TUBE ANGLE***	69	69
CS - CHAINSTAY LENGTH**	475	475
WB - WHEELBASE**	1107	1124
REACH**	396	409
STACK**	593	602
BB DROP**	75	75

* dimension in inches, ** dimension in mm, *** dimension in degrees

LILLE 1.0



SKU	SIZE	COLOUR	FINISH
LGLIZ126X15W006312	DS	purple-turquoise	gloss
LGLIZ126X17W006313	DM	purple-turquoise	gloss
LGLIZ126X15W006314	DS	orange-blue	gloss
LGLIZ126X17W006315	DM	orange-blue	gloss

GEAR RATIO 1 x 6

WHEEL DIAMETER 26"

COLOUR VARIANTS



FRAME

FRAME	ALUMINIUM
FORK	STAL
SIZES	DS(15"), DM(17")

DRIVETRAIN

REAR DERAILLEUR	SHIMANO TOURNEY TZ500
FRONT BRAKE	V-BRAKE
REAR BRAKE	V-BRAKE
BRAKE LEVERS	ALUMINIUM
SHIFTERS	SHIMANO RS36 REVOSHIFT
CRANKSET	CYCLONE
SPROCKETS	38T/170 mm
BOTTOM BRACKET	FP-B902
CHAIN	YBN Z33
CASSETTE/FREEWHEEL	SHIMANO TOURNEY MF-TZ500
CASSETTE/FREEWHEEL RANGE	14-28T

WHEELS

FRONT HUB	ALUMINIUM
REAR HUB	ALUMINIUM
RIMS	KROSS ALUMINIUM 559 x 19
TIRES	WANDA G5017 26 x 1,75

COMPONENTS

HANDLEBAR	STEEL 610 mm 25.4
HANDLEBAR STEM	STEEL 40 mm/25,4/30°
SEAT POST	STEEL 27,2 x 300
HEADSET	FP-H815 O1-1/8"
SADDLE	DDK D226K
GRIPS	SYNTHETIC LEATHER
PEDALS	FP-804
CARRIER	INTEGRATED
FRONT LIGHT	REFLECTION
REAR LIGHT	REFLECTION
MUDGUARDS	KROSS
KICK STAND	KROSS

GEOMETRY

SIZE	DS	DM
FS - FRAME SIZE*	15	17
ST - SEAT TUBE LENGTH**	380	430
TT - TOP TUBE LENGTH**	550	565
HT - HEAD TUBE LENGTH**	150	150
SA - SEAT TUBE ANGLE***	73	73
HA - HEAD TUBE ANGLE***	69	69
CS - CHAINSTAY LENGTH**	440	440
WB - WHEELBASE**	1058	1073
REACH**	383	398
STACK**	547	547
BB DROP**	40	40

* dimension in inches, ** dimension in mm, *** dimension in degrees

ELECTRIC BIKES

E-BIKE

Our passion for creating innovative solutions and top-tier quality products makes the bikes we produce an attractive alternative to traditional means of transportation.

Fascinated by the possibilities an electric bike offers, we strive to make ours accesible to everyone, allowing each person to experience the benefits of modern and sustainable transportation.

We aim for our electric bikes to be a symbol of modern lifestyle, combining ecology, healthy living and the joy of riding.

Join the community that chooses a sustainable and innovative way of traveling.



E-MTB

MOON BOOST

Moon Boost 1.0 is our most advanced electric bike, which in its conventional version, years ago gained recognition among enduro enthusiasts. Currently it is our first FS electric bike on a carbon frame created to enjoy enduro trails without losing energy on climbs.

Test yourself on steep descents and technical climbs thanks to the efficient Rock Shox suspension and Sram GX drivetrain.

Try the latest powerful Shimano EP8 motor, paired with 630Wh battery and choose from one of three assist modes – most suitable for your route.





MOON BOOST 1.0

NEW



SKU	SIZE	COLOUR	FINISH
KRMB1Z29X15M007258	S	grey-black	gloss
KRMB1Z29X16M007259	M	grey-black	gloss
KRMB1Z29X17M007260	L	grey-black	gloss
KRMB1Z29X19M007261	XL	grey-black	gloss

GEAR RATIO 1 x 12

WHEEL DIAMETER 29"

COLOUR VARIANTS



FRAME

FRAME	CARBON 4 BAR 150 mm
FORK	ROCK SHOX ZEB SELECT+ A1
FORK TRAVEL	160 mm
TYLNY AMORTYZATOR	ROCK SHOX VIIVD SELECT+ 205 x 62,5 mm
SIZES	S(15"), M(16"), L(17"), XL(19")

DRIVETRAIN

REAR DERAILLEUR	SRAM GX EAGLE
FRONT BRAKE	SRAM CODE SILVER
REAR BRAKE	SRAM CODE SILVER
BRAKE LEVERS	SRAM CODE SILVER
BRAKE DISCS	SRAM AVID CENTERLINE-A2 200 6B
SHIFTERS	SRAM GX EAGLE TRIGGER
CRANKSET	FSA CK-751
SPROCKETS	36T/ 170 mm
CHAIN	SRAM GX EAGLE
CASSETTE/FREEWHEEL	SRAM XG1275 EAGLE
CASSETTE/FREEWHEEL RANGE	10-52T

WHEELS

FRONT HUB	WTB 15 x 110
REAR HUB	WTB 12 x 148
RIMS	WTB HZT i30
TIRES	WTB VIGILANTE 29 x 2,6/2,5 TCS TOUGH/HIGH GRIP

COMPONENTS

HANDLEBAR	SRAM DESCENDANT 800
HANDLEBAR STEM	ALUMINIUM 50 mm/35/0°
SEAT POST	X-Fusion MANIC, 125 mm (S); 150 mm (M); 170 mm (L, XL)
HEADSET	FP-H856B2 1-1/8"-1.5"
SADDLE	WTB KODA
GRIPS	PROPALM STABLE II
BATTERY	SHIMANO BT-EN806 630WH
ENGINE	SHIMANO EP801
DISPLAY	SHIMANO SC-EM800

GEOMETRY

SIZE	S	M	L	XL
FS - FRAME SIZE*	15	16	17	19
ST - SEAT TUBE LENGTH**	380	410	440	470
TT - TOP TUBE LENGTH**	577	605	630	655
HT - HEAD TUBE LENGTH**	100	110	120	130
SA - SEAT TUBE ANGLE***	74	74	74	74
HA - HEAD TUBE ANGLE***	64,5	64,5	64,5	64,5
CS - CHAINSTAY LENGTH**	450	450	450	450
WB - WHEELBASE**	1215	1244	1271	1298
REACH**	435	460	483	505
STACK**	610	619	628	637
BB DROP**	20	20	20	20

* dimension in inches, ** dimension in mm, *** dimension in degrees

SOIL BOOST 2.0



SKU	SIZE	COLOUR	FINISH
KRSB2ZMUX16M004853	S	green-black	mat
KRSB2ZMUX17M004854	M	green-black	mat
KRSB2ZMUX19M004855	L	green-black	mat
KRSB2ZMUX20M004856	XL	green-black	mat

GEAR RATIO 1 x 12
WHEEL DIAMETER 27,5"/29"
COLOUR VARIANTS



FRAME

FRAME	ALUMINIUM PERFORMANCE RVS 140 mm
FORK	ROCK SHOX YARI RC
FORK TRAVEL	150 mm
TYLNY AMORTYZATOR	ROCK SHOX DELUXE SELECT R 210 x 50 mm
SIZES	S(16"), M(17"), L(19"), XL(20")

DRIVETRAIN

REAR DERAILLEUR	SHIMANO SLX M7100
FRONT BRAKE	SHIMANO XT M8120
REAR BRAKE	SHIMANO XT M8120
BRAKE LEVERS	SHIMANO XT M8100
BRAKE DISCS	SHIMANO EM600 203/180
SHIFTERS	SHIMANO SLX M7100
CRANKSET	FSA-CK751
SPROCKETS	38T/170 mm
CHAIN	SHIMANO M7100
CASSETTE/FREEWHEEL	SHIMANO SLX M7100
CASSETTE/FREEWHEEL RANGE	10-51T

WHEELS

FRONT HUB	SHIMANO MT400 15 x 110
REAR HUB	SHIMANO MT410 12 x 148
RIMS	WTB ST 140 TCS 2.0
TIRES	WTB TRAIL BOSS 27,5 x 2,6

COMPONENTS

HANDLEBAR	ALUMINIUM 760 mm 35
HANDLEBAR STEM	ALUMINIUM 55 mm/35/0°
SEAT POST	LEV-INTEGRA
HEADSET	FP-H856B2;1-1/8"-1.5"
SADDLE	VELO VL-1A47
GRIPS	KROSS STABLE
BATTERY	SIMPLO 630 WH
ENGINE	SHIMANO EP800
DISPLAY	SHIMANO SC-EM800

GEOMETRY

SIZE	S	M	L	XL
FS - FRAME SIZE*	16	17	19	20
ST - SEAT TUBE LENGTH**	410	440	470	500
TT - TOP TUBE LENGTH**	576	596	621	646
HT - HEAD TUBE LENGTH**	100	100	120	120
SA - SEAT TUBE ANGLE***	75	75	75	75
HA - HEAD TUBE ANGLE***	66,5	66,5	66,5	66,5
CS - CHAINSTAY LENGTH**	445	445	445	445
WB - WHEELBASE**	1155	1175	1203	1228
REACH**	417	437	457	482
STACK**	593	593	612	612
BB DROP**	32	32	32	32

* dimension in inches, ** dimension in mm, *** dimension in degrees

SOIL BOOST 1.0



FRAME

FRAME	ALUMINIUM PERFORMANCE RVS 140 mm
FORK	SR SUNTOUR AION 35 LOR
FORK TRAVEL	150 mm
TYLNY AMORTYZATOR	ROCK SHOX DELUXE SELECT R 210 x 50 mm
SIZES	S(17"), L(19"), XL(20")

DRIVETRAIN

REAR DERAILLEUR	SHIMANO DEORE M6100
FRONT BRAKE	SHIMANO MT520
REAR BRAKE	SHIMANO MT520
BRAKE LEVERS	SHIMANO MT501
BRAKE DISCS	SHIMANO EM300 203/180
SHIFTERS	SHIMANO DEORE M6100
CRANKSET	FSA-CK751
SPROCKETS	38T/170 mm
CHAIN	SHIMANO M6100
CASSETTE/FREEWHEEL	SHIMANO SLX M7100
CASSETTE/FREEWHEEL RANGE	10-51T

WHEELS

FRONT HUB	SHIMANO MT400 15 x 110
REAR HUB	SHIMANO MT410 12 x 148
RIMS	WTB ST 140 TCS 2.0
TIRES	WTB TRAIL BOSS 27,5 x 2,6

COMPONENTS

HANDLEBAR	ALUMINIUM 760 mm 35
HANDLEBAR STEM	ALUMINIUM 55 mm/35/0°
SEAT POST	EXAFORM KSP900I
HEADSET	FP-H856B2;1-1/8"-1.5"
SADDLE	VELO VL-1A47
GRIPS	KROSS STABLE
BATTERY	SIMPL0 630 WH
ENGINE	SHIMANO EP800
DISPLAY	SHIMANO SC-EM800

GEOMETRY

SIZE	S	L	XL
FS - FRAME SIZE*	17	19	20
ST - SEAT TUBE LENGTH**	440	470	500
TT - TOP TUBE LENGTH**	608	635	660
HT - HEAD TUBE LENGTH**	100	120	120
SA - SEAT TUBE ANGLE***	67	67	67
HA - HEAD TUBE ANGLE***	63	63	63
CS - CHAINSTAY LENGTH**	445	445	445
WB - WHEELBASE**	1175	1203	1228
REACH**	404	424	448
STACK**	616	635	636
BB DROP**	13,5	13,5	13,5

* dimension in inches, ** dimension in mm, *** dimension in degrees

GEAR RATIO 1 x 12
WHEEL DIAMETER 27,5"/29"
COLOUR VARIANTS



SKU	SIZE	COLOUR	FINISH
KRSB1ZMUX16M004849	S	graphite-black	gloss
KRSB1ZMUX19M004851	L	graphite-black	gloss
KRSB1ZMUX20M004852	XL	graphite-black	gloss

SOIL BOOST 1.0



SKU	SIZE	COLOUR	FINISH
KRSB1ZMUX16M005531	S	green-black	mat
KRSB1ZMUX17M005532	M	green-black	mat
KRSB1ZMUX19M005533	L	green-black	mat
KRSB1ZMUX20M005534	XL	green-black	mat
KRSB1ZMUX17M005528	M	black-black	mat
KRSB1ZMUX19M005529	L	black-black	mat

GEAR RATIO 1 x 12
WHEEL DIAMETER 27,5"/29"
COLOUR VARIANTS

FRAME

FRAME	ALUMINIUM PERFORMANCE RVS 140 mm
FORK	SR SUNTOUR AION 35 LOR
FORK TRAVEL	150 mm
TYLNY AMORTYZATOR	ROCK SHOX DELUXE SELECT R 210 x 50 mm
SIZES	S(16"), M(17"), L(19"), XL(20")

DRIVETRAIN

REAR DERAILLEUR	SHIMANO DEORE M6100
FRONT BRAKE	SHIMANO MT520
REAR BRAKE	SHIMANO MT520
BRAKE LEVERS	SHIMANO MT501
BRAKE DISCS	SHIMANO EM300 203/180
SHIFTERS	SHIMANO DEORE M6100
CRANKSET	FSA-CK751
SPROCKETS	38T/170 mm
CHAIN	SHIMANO M6100
CASSETTE/FREEWHEEL	SHIMANO DEORE M6100
CASSETTE/FREEWHEEL RANGE	10-51T

WHEELS

FRONT HUB	SHIMANO MT400 15 x 110
REAR HUB	SHIMANO MT410 12 x 148
RIMS	WTB ST 140 TCS 2.0
TIRES	WTB TRAIL BOSS 27,5 x 2,6

COMPONENTS

HANDLEBAR	ALUMINIUM 760 mm 35
HANDLEBAR STEM	ALUMINIUM 55 mm/35/0°
SEAT POST	EXAFORM KSP900I
HEADSET	FP-H856B2;1-1/8"-1.5"
SADDLE	VELO VL-1A47
GRIPS	KROSS STABLE
BATTERY	SIMPLO 630 WH
ENGINE	SHIMANO EP800
DISPLAY	SHIMANO SC-EM800

GEOMETRY

SIZE	S	M	L	XL
FS - FRAME SIZE*	16	17	19	20
ST - SEAT TUBE LENGTH**	410	440	470	500
TT - TOP TUBE LENGTH**	576	608	635	660
HT - HEAD TUBE LENGTH**	100	100	120	120
SA - SEAT TUBE ANGLE***	67	67	67	67
HA - HEAD TUBE ANGLE***	63	63	63	63
CS - CHAINSTAY LENGTH**	445	445	445	445
WB - WHEELBASE**	1155	1175	1203	1228
REACH**	417	404	424	448
STACK**	593	616	635	636
BB DROP**	32	13,5	13,5	13,5

* dimension in inches, ** dimension in mm, *** dimension in degrees

E-MTB

GRIST BOOST

The latest version of the Grist Boost, from trail-oriented, analog hardtail, has transformed into an even more trail-focused design with 4-bar suspension layout featuring 140 mm of travel and powerful electric assistance from the BAFANG M510 motor with 95Nm of torque.

This transformation also responds to market demands, where the Grist Boost, equipped with a 730Wh battery and optimized for e-BIKE Shimano CUES drivetrain, will find fans who want to ride longer and farther.



GRIST BOOST 1.0



SKU	SIZE	COLOUR	FINISH
KRGB1Z29X14U006747	S	brown-black	gloss
KRGB1Z29X15U006748	M	brown-black	gloss
KRGB1Z29X16U006749	L	brown-black	gloss
KRGB1Z29X17U006750	XL	brown-black	gloss
KRGB1Z29X18U007472	XXL	brown-black	gloss
KRGB1Z29X14U006751	S	yellow-black	gloss
KRGB1Z29X15U006752	M	yellow-black	gloss
KRGB1Z29X16U006753	L	yellow-black	gloss
KRGB1Z29X17U006754	XL	yellow-black	gloss
KRGB1Z29X18U007473	XXL	yellow-black	gloss

GEAR RATIO 1 x 10

WHEEL DIAMETER 29"

COLOUR VARIANTS



FRAME

FRAME	ALUMINIUM 4-BAR 140 mm
FORK	SR SUNTOUR XCR 34 BOOST 2CR
FORK TRAVEL	140 mm
TYLNY AMORTYZATOR	SR SUNTOUR RAIDON LO 190 x 51 mm
SIZES	S(14"), M(15"), L(16"), XL(17"), XXL(18")

DRIVETRAIN

REAR DERAILLEUR	SIMANO CUES RD U6000
FRONT BRAKE	SHIMANO MT420
REAR BRAKE	SHIMANO MT420
BRAKE LEVERS	SHIMANO M4100
BRAKE DISCS	SHIMANO RT30 203/180 CL
SHIFTERS	SHIMANO CUS E U6000
KORBY	BAFANG M510
SPROCKETS	52T/ 170 mm
CHAIN	SHIMANO LG500
CASSETTE/FREEWHEEL	SHIMANO CUES LG300
CASSETTE/FREEWHEEL RANGE	11-48T

WHEELS

FRONT HUB	SHIMANO MT400
REAR HUB	SHIMANO ALIVIO MT400
RIMS	WTB ST 130 TCS 2.0
TIRES	WTB TRAIL BOSS 29 x 2,4

COMPONENTS

HANDLEBAR	ALUMINIUM 780 mm 35
HANDLEBAR STEM	ALUMINIUM 55 mm/35/0
SEAT POST	X-Fusion MANIC LC, 125 mm (S, M); 150 mm (L); 170 mm (XL, XXL)
HEADSET	FP-H856B2 1-1/8"-1.5"
SADDLE	VELO VL-1A47
GRIPS	PROPALM STABLE II
FRONT LIGHT	HERRMANS NORDIC MR10 E-BIKE STVZO 220 LUMEN
REAR LIGHT	SKS INFINITY E-BIKE
BATTERY	PATHFINDER BATTERY 730WH
ENGINE	BAFANG M510
DISPLAY	BAFANG DP C245

GEOMETRY

SIZE	S	M	L	XL	XXL
FS - FRAME SIZE*	14	15	16	17	18
ST - SEAT TUBE LENGTH**	368	393	419	444	450
TT - TOP TUBE LENGTH**	563	596	611	631	651
HT - HEAD TUBE LENGTH**	120	130	140	145	145
SA - SEAT TUBE ANGLE***	73	73	73	73	73
HA - HEAD TUBE ANGLE***	66	66	66	66	66
CS - CHAINSTAY LENGTH**	460	460	460	460	460
WB - WHEELBASE**	1210	1238	1252	1274	1294
REACH**	420	445	460	480	500
STACK**	614	623	635	640	640
BB DROP**	15	15	15	15	15

* dimension in inches, ** dimension in mm, *** dimension in degrees

E-SUV

GRIST BOOST SUV

We are adding a more utilitarian version to the Grist Boost family, which takes its nickname "SUV" from the well-known automotive acronym, standing for Sports Utility Vehicle. This aligns well with the character of our new Grist Boost SUV, which, thanks to its full equipment with aluminum fenders, a rack, lighting, and a kickstand, will accompany you in your everyday activities, such as your commute to work. Additionally, with its 130 mm of full suspension travel, it won't mind how the road conditions really are.

Just like its trail's brother, it features the same powerful e-set from Bafang, a CUES drivetrain from Shimano, and an adjustable dropper seatpost to enhance its off-road capabilities when you have more free time for a ride.



GRIST BOOST 1.0 SUV



SKU	SIZE	COLOUR	FINISH
KRGS1Z29X14U006755	S	black	mat
KRGS1Z29X15U006756	M	black	mat
KRGS1Z29X16U006757	L	black	mat
KRGS1Z29X17U006758	XL	black	mat
KRGS1Z29X14U006759	S	green-black	gloss
KRGS1Z29X15U006760	M	green-black	gloss
KRGS1Z29X16U006761	L	green-black	gloss
KRGS1Z29X17U006762	XL	green-black	gloss

GEAR RATIO 1 x 10

WHEEL DIAMETER 29"

COLOUR VARIANTS



FRAME

FRAME	ALUMINIUM 4-BAR 130 mm
FORK	SR SUNTOUR XCR 34 BOOST 2CR
FORK TRAVEL	130 mm
TYLNY AMORTYZATOR	SR SUNTOUR RAIDON LO
SIZES	S(14"), M(15"), L(16"), XL(17")

DRIVETRAIN

REAR DERAILLEUR	SIMANO CUES RD U6000
FRONT BRAKE	SHIMANO MT420
REAR BRAKE	SHIMANO MT420
BRAKE LEVERS	SHIMANO CUSE U6000
BRAKE DISCS	SHIMANO RT30 203/180 CL
SHIFTERS	SHIMANO CUSE U6000
KORBY	BAFANG 170 mm
SPROCKETS	NARROW WIDE 38T
CHAIN	SHIMANO LG500
CASSETTE/FREEWHEEL	SHIMANO CUES LG300
CASSETTE/FREEWHEEL RANGE	11-48T

WHEELS

FRONT HUB	SHIMANO MT400
REAR HUB	SHIMANO ALIVIO MT400
RIMS	WTB ST 130 TCS 2.0
TIRES	WTB INTERSECTOR 29 x 2,4

COMPONENTS

HANDLEBAR	ALUMINIUM 780 mm 35
HANDLEBAR STEM	ALUMINIUM 55 mm/35/0°
SEAT POST	X-FUSION MANIC 30,9 POST
HEADSET	FP-H856B2 1-1/8"-1.5"
SADDLE	VELO VL-1A47
GRIPS	PROPALM STABLE II
CARRIER	SKS INFINITY
FRONT LIGHT	KROSS
REAR LIGHT	KROSS
MUDGUARDS	SKS INFINITY
KICK STAND	REAR EMARABOU
BATTERY	PATHFINDER BATTERY 730WH
ENGINE	BAFANG M510
DISPLAY	BAFANG DP C245

GEOMETRY

SIZE	S	M	L	XL
FS - FRAME SIZE*	14	15	16	17
ST - SEAT TUBE LENGTH**	368	393	419	444
TT - TOP TUBE LENGTH**	563	596	611	631
HT - HEAD TUBE LENGTH**	120	130	140	145
SA - SEAT TUBE ANGLE***	73	73	73	73
HA - HEAD TUBE ANGLE***	66	66	66	66
CS - CHAINSTAY LENGTH**	460	460	460	460
WB - WHEELBASE**	1210	1238	1252	1274
REACH**	420	445	460	480
STACK**	614	623	635	640
BB DROP**	15	15	15	15

* dimension in inches, ** dimension in mm, *** dimension in degrees

E-MTB HT

LEVEL, HEXAGON, LEA BOOST

This is a series of hardtail mountain e-bikes that has been designed to transfer the experience of riding conventional counterparts with the added support of electric power.

Geometry: tailor the geometry to your preferences by choosing Level Boost with a sporty geometry for confident handling and excellent manoeuvrability on mountain trails or Hexagon Boost and Lea Boost with a comfortable geometry for comfort and stability on more challenging terrain.

Multifunctionality: thanks to the electric drive, each of these bikes is a multifunctional tool suitable for both daily commuting and recreational trips on mountain trails.

According to your needs, choose between extended range and ample battery capacity in Hexagon Boost bikes and Lea Boost bikes, or nimble handling in Level Boost models.





LEVEL BOOST 3.0



SKU	SIZE	COLOUR	FINISH
KRVB3Z29X16M005519	S	pearly-black	gloss
KRVB3Z29X18M005520	M	pearly-black	gloss
KRVB3Z29X20M005521	L	pearly-black	gloss
KRVB3Z29X22M005522	XL	pearly-black	gloss
KRVB3Z29X16M005523	S	black-gray	gloss
KRVB3Z29X18M005524	M	black-gray	gloss
KRVB3Z29X20M005525	L	black-gray	gloss
KRVB3Z29X22M005526	XL	black-gray	gloss

GEAR RATIO 1 x 12

WHEEL DIAMETER 29"

COLOUR VARIANTS



FRAME

FRAME	ALUMINIUM PERFORMANCE
FORK	ROCK SHOX GOLD 35 RL
FORK TRAVEL	120 mm
SIZES	S(16"), M(18"), L(20"), XL(21")

DRIVETRAIN

REAR DERAILLEUR	SHIMANO SLX M7100
FRONT BRAKE	SHIMANO DEORE M6100
REAR BRAKE	SHIMANO DEORE M6100
BRAKE LEVERS	SHIMANO DEORE M6100
BRAKE DISCS	SHIMANO RT30 (203)
SHIFTERS	SHIMANO DEORE M6100
CRANKSET	FSA-CK751
SPROCKETS	38T/170 mm
CHAIN	SHIMANO M7100
CASSETTE/FREEWHEEL	SHIMANO SLX M7100
CASSETTE/FREEWHEEL RANGE	10-51T

WHEELS

FRONT HUB	SHIMANO MT400 15 x 110
REAR HUB	SHIMANO MT410 12 x 148
RIMS	WTB ST I25

COMPONENTS

HANDLEBAR	ALUMINIUM 740 mm 31.8
HANDLEBAR STEM	ALUMINIUM 60 mm/31,8/3°
SEAT POST	ALUMINIUM 27,2 x 350 mm
HEADSET	FP-H856B2,1-1/8"-1.5"
SADDLE	VELO VL-1A47
GRIPS	KROSS STABLE
BATTERY	SIMPLO 630 WH
ENGINE	SHIMANO EP800
DISPLAY	SHIMANO SC-EM800

GEOMETRY

SIZE	S	M	L	XL
FS - FRAME SIZE*	16	18	20	21
ST - SEAT TUBE LENGTH**	410	450	500	530
TT - TOP TUBE LENGTH**	593	610	627	642
HT - HEAD TUBE LENGTH**	120	130	140	150
SA - SEAT TUBE ANGLE***	73	73	73	73
HA - HEAD TUBE ANGLE***	68	68	68	68
CS - CHAINSTAY LENGTH**	460	460	460	460
WB - WHEELBASE**	1145	1163	1181	1197
REACH**	399	413	427	439
STACK**	635	644	653	663
BB DROP**	55	55	55	55

* dimension in inches, ** dimension in mm, *** dimension in degrees

LEVEL BOOST 2.0



SKU	SIZE	COLOUR	FINISH
KRVB2Z29X16M005511	S	ruby red-golden	gloss
KRVB2Z29X18M005512	M	ruby red-golden	gloss
KRVB2Z29X20M005513	L	ruby red-golden	gloss
KRVB2Z29X22M005514	XL	ruby red-golden	gloss
KRVB2Z29X16M005515	S	brown-golden	gloss
KRVB2Z29X18M005516	M	brown-golden	gloss
KRVB2Z29X20M005517	L	brown-golden	gloss
KRVB2Z29X22M005518	XL	brown-golden	gloss

GEAR RATIO 1 x 11

WHEEL DIAMETER 29"

COLOUR VARIANTS



FRAME

FRAME	ALUMINIUM PERFORMANCE
FORK	SR SUNTOUR XCR 34 RLR AIR
FORK TRAVEL	120 mm
SIZES	S(16"), M(18"), L(20"), XL(21")

DRIVETRAIN

REAR DERAILLEUR	SHIMANO DEORE M5100
FRONT BRAKE	SHIMANO MT500
REAR BRAKE	SHIMANO MT500
BRAKE LEVERS	SHIMANO MT501
BRAKE DISCS	SHIMANO RT30 (203)
SHIFTERS	SHIMANO DEORE M5100
CRANKSET	FSA-CK751
SPROCKETS	38T/170 mm
CHAIN	SHIMANO HG601
CASSETTE/FREEWHEEL	SHIMANO DEORE M5100
CASSETTE/FREEWHEEL RANGE	11-51T

WHEELS

FRONT HUB	SHIMANO MT400 15 x 110
REAR HUB	SHIMANO MT400 12 x 148
RIMS	KROSS

COMPONENTS

HANDLEBAR	ALUMINIUM 740 mm 31.8
HANDLEBAR STEM	ALUMINIUM 60 mm/31,8/3°
SEAT POST	ALUMINIUM 27,2 x 350 mm
HEADSET	FP-H856B2,1-1/8"-1.5"
SADDLE	VELO VL-1A47
GRIPS	KROSS STABLE
BATTERY	SIMPLO 504 WH
ENGINE	SHIMANO EP800
DISPLAY	SHIMANO SC-EM800

GEOMETRY

SIZE	S	M	L	XL
FS - FRAME SIZE*	16	18	20	21
ST - SEAT TUBE LENGTH**	410	450	500	530
TT - TOP TUBE LENGTH**	593	610	627	642
HT - HEAD TUBE LENGTH**	120	130	140	150
SA - SEAT TUBE ANGLE***	73	73	73	73
HA - HEAD TUBE ANGLE***	68	68	68	68
CS - CHAINSTAY LENGTH**	460	460	460	460
WB - WHEELBASE**	1145	1163	1181	1197
REACH**	399	413	427	439
STACK**	635	644	653	663
BB DROP**	55	55	55	55

* dimension in inches, ** dimension in mm, *** dimension in degrees

LEVEL BOOST 2.0



SKU	SIZE	COLOUR	FINISH
KRVB2Z29X16M004841	S	blue-black	gloss
KRVB2Z29X18M004842	M	blue-black	gloss
KRVB2Z29X20M004843	L	blue-black	gloss
KRVB2Z29X22M004844	XL	blue-black	gloss

GEAR RATIO 1 x 11

WHEEL DIAMETER 29"

COLOUR VARIANTS



FRAME

FRAME	ALUMINIUM PERFORMANCE
FORK	SR SUNTOUR XCR 34 RLR AIR
FORK TRAVEL	120 mm
SIZES	S(16"), M(18"), L(20"), XL(22")

DRIVETRAIN

REAR DERAILLEUR	SHIMANO DEORE M5100
FRONT BRAKE	SHIMANO MT500
REAR BRAKE	SHIMANO MT500
BRAKE LEVERS	SHIMANO MT501
BRAKE DISCS	SHIMANO RT30 (203)
SHIFTERS	SHIMANO DEORE M5100
CRANKSET	FSA-CK751
SPROCKETS	38T/170 mm
CHAIN	SHIMANO HG601
CASSETTE/FREEWHEEL	SHIMANO DEORE M5100
CASSETTE/FREEWHEEL RANGE	11-51T

WHEELS

FRONT HUB	SHIMANO MT400 15 x 110
REAR HUB	SHIMANO MT400 12 x 148
RIMS	KROSS

COMPONENTS

HANDLEBAR	ALUMINIUM 740 mm 31.8
HANDLEBAR STEM	ALUMINIUM 60 mm/31.8/3°
SEAT POST	ALUMINIUM 27,2 x 350 mm
HEADSET	FP-H856B2,1-1/8"-1.5"
SADDLE	DDK D5311
GRIPS	KROSS SCALE
BATTERY	SIMPLO 504 WH
ENGINE	SHIMANO EP800
DISPLAY	SHIMANO SC-EM800

GEOMETRY

SIZE	S	M	L	XL
FS - FRAME SIZE*	16	18	20	22
ST - SEAT TUBE LENGTH**	410	450	500	550
TT - TOP TUBE LENGTH**	593	610	627	642
HT - HEAD TUBE LENGTH**	120	130	140	150
SA - SEAT TUBE ANGLE***	73	73	73	73
HA - HEAD TUBE ANGLE***	68	68	68	68
CS - CHAINSTAY LENGTH**	460	460	460	453
WB - WHEELBASE**	1145	1163	1181	1190
REACH**	399	413	427	439
STACK**	635	644	653	663
BB DROP**	55	55	55	55

* dimension in inches, ** dimension in mm, *** dimension in degrees

LEVEL BOOST 1.0



SKU	SIZE	COLOUR	FINISH
KRVB1Z29X16M005503	S	grey-black	mat
KRVB1Z29X18M005504	M	grey-black	mat
KRVB1Z29X20M005505	L	grey-black	mat
KRVB1Z29X21M005506	XL	grey-black	mat
KRVB1Z29X16M005507	S	yellow-black	gloss
KRVB1Z29X18M005508	M	yellow-black	gloss
KRVB1Z29X20M005509	L	yellow-black	gloss
KRVB1Z29X21M005510	XL	yellow-black	gloss

GEAR RATIO 1 x 10

WHEEL DIAMETER 29"

COLOUR VARIANTS



FRAME

FRAME	ALUMINIUM LITE
FORK	SR SUNTOUR XCM32 BOOST RL
FORK TRAVEL	120 mm
SIZES	S(16"), M(18"), L(20"), XL(21")

DRIVETRAIN

REAR DERAILLEUR	SHIMANO DEORE M5120
FRONT BRAKE	SHIMANO MT200
REAR BRAKE	SHIMANO MT200
BRAKE LEVERS	SHIMANO MT200
BRAKE DISCS	SHIMANO RT10 (180 mm)
SHIFTERS	SHIMANO DEORE M4100
CRANKSET	FSA-CK751
SPROCKETS	38T/170 mm
CHAIN	SHIMANO E6090
CASSETTE/FREEWHEEL	SHIMANO DEORE M4100
CASSETTE/FREEWHEEL RANGE	11-46T

WHEELS

FRONT HUB	SHIMANO MT400 15 x 100
REAR HUB	SHIMANO MT400 12 x 148
RIMS	KROSS

COMPONENTS

HANDLEBAR	ALUMINIUM 740 mm 31.8
HANDLEBAR STEM	ALUMINIUM 60 mm/31.8/3°
SEAT POST	ALUMINIUM 31,6 x 350 mm
HEADSET	FP-H856B2 1-1/8"-1.5"
SADDLE	SELLE ROYAL ERGO MAN
GRIPS	KROSS STABLE
BATTERY	SIMPLO 504 WH
ENGINE	SHIMANO E7000
DISPLAY	SHIMANO SC-E7000

GEOMETRY

SIZE	S	M	L	XL
FS - FRAME SIZE*	16	18	20	21
ST - SEAT TUBE LENGTH**	410	450	500	530
TT - TOP TUBE LENGTH**	593	610	627	642
HT - HEAD TUBE LENGTH**	120	130	140	150
SA - SEAT TUBE ANGLE***	73	73	73	73
HA - HEAD TUBE ANGLE***	68	68	68	68
CS - CHAINSTAY LENGTH**	460	460	460	460
WB - WHEELBASE**	1145	1163	1181	1197
REACH**	399	413	427	439
STACK**	635	644	653	663
BB DROP**	55	55	55	55

* dimension in inches, ** dimension in mm, *** dimension in degrees

HEXAGON BOOST 5.0



SKU	SIZE	COLOUR	FINISH
KRHB5Z29X16M004807	S	blue-white	gloss
KRHB5Z29X18M004808	M	blue-white	gloss
KRHB5Z29X20M004992	L	blue-white	gloss
KRHB5Z29X21M004810	XL	blue-white	gloss

GEAR RATIO 1 x 9

WHEEL DIAMETER 29"

COLOUR VARIANTS



FRAME

FRAME	ALUMINIUM
FORK	SR SUNTOUR XCM ATB HLO
FORK TRAVEL	100 mm
SIZES	S(16"), M(18"), L(20"), XL(21")

DRIVETRAIN

REAR DERAILLEUR	MICROSHIFT ADVENT M619S
FRONT BRAKE	POWER BH-M960
REAR BRAKE	POWER BH-M960
BRAKE LEVERS	POWER BH-M960
BRAKE DISCS	DISC (160 mm)
SHIFTERS	SL-M819-R
CRANKSET	BAFANG
SPROCKETS	38T/170 mm
CHAIN	YBN S9E
CASSETTE/FREEWHEEL	MICROSHIFT CS-H093
CASSETTE/FREEWHEEL RANGE	11-46T

WHEELS

FRONT HUB	GL-B43F-DS
REAR HUB	GL-B43R-DS
RIMS	KROSS

COMPONENTS

HANDLEBAR	ALUMINIUM 740 mm 31.8
HANDLEBAR STEM	ALUMINIUM 60 mm/31.8/3°
SEAT POST	ALUMINIUM 31,6 x 350 mm
HEADSET	ALUMINIUM
SADDLE	KROSS
GRIPS	KROSS
PEDALS	FP-917N
BATTERY	PATHFINDER BATTERY 882WH
ENGINE	BAFANG M400
DISPLAY	DISPLAY DP C11 CAN

GEOMETRY

SIZE	S	M	L	XL
FS - FRAME SIZE*	16	18	20	21
ST - SEAT TUBE LENGTH**	410	450	500	530
TT - TOP TUBE LENGTH**	598	615	632	647
HT - HEAD TUBE LENGTH**	130	140	150	150
SA - SEAT TUBE ANGLE***	74,5	74	73,5	73
HA - HEAD TUBE ANGLE***	67	67	67	67
CS - CHAINSTAY LENGTH**	490	490	490	490
WB - WHEELBASE**	1202	1215	1227	1236
REACH**	422	430	438	447
STACK**	636	645	654	654
BB DROP**	60	60	60	60

* dimension in inches, ** dimension in mm, *** dimension in degrees

HEXAGON BOOST 4.0



SKU	SIZE	COLOUR	FINISH
KRHB4Z29X16M004803	S	khaki-graphite	gloss
KRHB4Z29X18M004804	M	khaki-graphite	gloss
KRHB4Z29X20M004991	L	khaki-graphite	gloss
KRHB4Z29X21M004806	XL	khaki-graphite	gloss

GEAR RATIO 1 x 9

WHEEL DIAMETER 29"

COLOUR VARIANTS



FRAME

FRAME	ALUMINIUM
FORK	SR SUNTOUR XCM ATB HLO
FORK TRAVEL	100 mm
SIZES	S(16"), M(18"), L(20"), XL(21")

DRIVETRAIN

REAR DERAILLEUR	MICROSHIFT ADVENT M6195
FRONT BRAKE	POWER BH-M960
REAR BRAKE	POWER BH-M960
BRAKE LEVERS	POWER BH-M960
BRAKE DISCS	DISC (160 mm)
SHIFTERS	SL-M819-R
CRANKSET	BAFANG
SPROCKETS	38T/170 mm
CHAIN	YBN S9E
CASSETTE/FREEWHEEL	MICROSHIFT CS-H093
CASSETTE/FREEWHEEL RANGE	11-46T

WHEELS

FRONT HUB	GL-B43F-DS
REAR HUB	GL-B43R-DS
RIMS	KROSS

COMPONENTS

HANDLEBAR	ALUMINIUM 740 mm 31.8
HANDLEBAR STEM	ALUMINIUM 60 mm/31.8/3°
SEAT POST	ALUMINIUM 31,6 x 350 mm
HEADSET	ALUMINIUM
SADDLE	KROSS
GRIPS	KROSS
PEDALS	FP-917N
BATTERY	PATHFINDER BATTERY 730WH
ENGINE	BAFANG M400
DISPLAY	DISPLAY DP C11 CAN

GEOMETRY

SIZE	S	M	L	XL
FS - FRAME SIZE*	16	18	20	21
ST - SEAT TUBE LENGTH**	410	450	500	530
TT - TOP TUBE LENGTH**	598	615	632	647
HT - HEAD TUBE LENGTH**	130	140	150	150
SA - SEAT TUBE ANGLE***	74,5	74	73,5	73
HA - HEAD TUBE ANGLE***	67	67	67	67
CS - CHAINSTAY LENGTH**	490	490	490	490
WB - WHEELBASE**	1202	1215	1227	1236
REACH**	422	430	438	447
STACK**	636	645	654	654
BB DROP**	60	60	60	60

* dimension in inches, ** dimension in mm, *** dimension in degrees

HEXAGON BOOST 3.0



GEAR RATIO 1 x 8

WHEEL DIAMETER 29"

COLOUR VARIANTS



SKU	SIZE	COLOUR	FINISH
KRHB3Z29X16M004799	S	silver-black	gloss
KRHB3Z29X18M004800	M	silver-black	gloss
KRHB3Z29X20M004990	L	silver-black	gloss
KRHB3Z29X21M004802	XL	silver-black	gloss

FRAME

FRAME	ALUMINIUM
FORK	SR SUNTOUR XCM ATB HLO
FORK TRAVEL	100 mm
SIZES	S(16"), M(18"), L(20"), XL(21")

DRIVETRAIN

REAR DERAILLEUR	MICROSHIFT ACOLYTE
FRONT BRAKE	POWER BH-M960
REAR BRAKE	POWER BH-M960
BRAKE LEVERS	POWER BH-M960
BRAKE DISCS	DISC (160 mm)
SHIFTERS	SL-M7180-R
CRANKSET	BAFANG
SPROCKETS	38T/170 mm
CHAIN	YBN S8E
CASSETTE/FREEWHEEL	MICROSHIFT CS-H083
CASSETTE/FREEWHEEL RANGE	11-42T

WHEELS

FRONT HUB	GL-B43F-DS
REAR HUB	GL-B43R-DS
RIMS	KROSS

COMPONENTS

HANDLEBAR	ALUMINIUM 740 mm 31.8
HANDLEBAR STEM	ALUMINIUM 60 mm/31.8/3°
SEAT POST	ALUMINIUM 31,6 x 350 mm
HEADSET	ALUMINIUM
SADDLE	KROSS
GRIPS	KROSS
PEDALS	FP-917N
BATTERY	PATHFINDER BATTERY 576WH
ENGINE	BAFANG M400
DISPLAY	DISPLAY DP C11 CAN

GEOMETRY

SIZE	S	M	L	XL
FS - FRAME SIZE*	16	18	20	21
ST - SEAT TUBE LENGTH**	410	450	500	530
TT - TOP TUBE LENGTH**	598	615	632	647
HT - HEAD TUBE LENGTH**	130	140	150	150
SA - SEAT TUBE ANGLE***	74,5	74	73,5	73
HA - HEAD TUBE ANGLE***	67	67	67	67
CS - CHAINSTAY LENGTH**	490	490	490	490
WB - WHEELBASE**	1202	1215	1227	1236
REACH**	422	430	438	447
STACK**	636	645	654	654
BB DROP**	60	60	60	60

* dimension in inches, ** dimension in mm, *** dimension in degrees

HEXAGON BOOST 2.0



SKU	SIZE	COLOUR	FINISH
KRHB2Z29X16M003108	S	brown-black	gloss
KRHB2Z29X18M003109	M	brown-black	gloss
KRHB2Z29X19M003110	L	brown-black	gloss
KRHB2Z29X21M003111	XL	brown-black	gloss

GEAR RATIO 1 x 8

WHEEL DIAMETER 29"

COLOUR VARIANTS



FRAME

FRAME	ALUMINIUM
FORK	SR SUNTOUR XCM ATB HLO
FORK TRAVEL	100 mm
SIZES	S(16"), M(18"), L(19"), XL(21")

DRIVETRAIN

REAR DERAILLEUR	MICROSHIFT ACOLYTE
FRONT BRAKE	POWER BH-M960
REAR BRAKE	POWER BH-M960
BRAKE LEVERS	POWER BH-M960
BRAKE DISCS	POWER RT600 160 6B
SHIFTERS	MICROSHIFT ACOLYTE
CRANKSET	WHEEL TOP
SPROCKETS	38T/175 mm
BOTTOM BRACKET	ROTATION SENSOR
CHAIN	YBN E-BIKE
CASSETTE/FREEWHEEL	MICROSHIFT CS-H083
CASSETTE/FREEWHEEL RANGE	11-42T

WHEELS

FRONT HUB	GL-B43F-DS
RIMS	KROSS

COMPONENTS

HANDLEBAR	ALUMINIUM 720 mm 31.8
HANDLEBAR STEM	ALUMINIUM 60 mm/31.8/3°
SEAT POST	ALUMINIUM 27,2 x 350 mm
HEADSET	FP-H816 O1-1/8"
SADDLE	KROSS
GRIPS	KROSS SCALE
PEDALS	FP-917N
BATTERY	HYENA GIRAFFE 360 Wh
ENGINE	HYENA MRC-250
DISPLAY	HYENA CROCO H

GEOMETRY

SIZE	S	M	L	XL
FS - FRAME SIZE*	16	18	19	21
ST - SEAT TUBE LENGTH**	400	450	500	530
TT - TOP TUBE LENGTH**	590	610	627	642
HT - HEAD TUBE LENGTH**	130	140	150	150
SA - SEAT TUBE ANGLE***	73	73	73	73
HA - HEAD TUBE ANGLE***	68	68	68	68
CS - CHAINSTAY LENGTH**	460	460	460	460
WB - WHEELBASE**	1141	1162	1180	1195
REACH**	398	415	430	445
STACK**	627	637	646	647
BB DROP**	55	55	55	55

* dimension in inches, ** dimension in mm, *** dimension in degrees

HEXAGON BOOST 1.0



SKU	SIZE	COLOUR	FINISH
KRHB1Z29X17M004245	M	black-red	mat
KRHB1Z29X19M004246	L	black-red	mat
KRHB1Z29X21M004247	XL	black-red	mat

GEAR RATIO 3 x 8

WHEEL DIAMETER 29"

COLOUR VARIANTS



FRAME

FRAME	ALUMINIUM LITE
FORK	SR SUNTOUR XCT30 HLO
FORK TRAVEL	100 mm
SIZES	M(17"), L(19"), XL(21")

DRIVETRAIN

FRONT DERAILLEUR	SHIMANO TOURNEY TY700
REAR DERAILLEUR	SHIMANO ACERA M360
FRONT BRAKE	SHIMANO ALTUS ST-EF505
REAR BRAKE	SHIMANO MT200
BRAKE LEVERS	SHIMANO ALTUS ST-EF505
BRAKE DISCS	DISC (160 mm)
SHIFTERS	SHIMANO EF505
CRANKSET	SHIMANO TY301
SPROCKETS	42T-34T-24T/175 mm
BOTTOM BRACKET	BAFANG
CHAIN	YBN S8
CASSETTE/FREEWHEEL	SHIMANO HG200
CASSETTE/FREEWHEEL RANGE	12-32T

WHEELS

FRONT HUB	GL-B43F-DS
REAR HUB	BAFANG G120.250.DC
RIMS	KROSS

COMPONENTS

HANDLEBAR	ALUMINIUM 680 mm 31.8
HANDLEBAR STEM	ALUMINIUM 75 mm/31,8/7°
SEAT POST	ALUMINIUM 27,2 x 300 mm
HEADSET	FP-H816 O1-1/8"
SADDLE	KROSS
GRIPS	KROSS SCALE
PEDALS	FP-917N
BATTERY	PHYLION SF-06S
ENGINE	BAFANG G120.250.DC 522 Wh
DISPLAY	BAFANG HMI DP E12.CANBUS

GEOMETRY

SIZE	M	L	XL
FS - FRAME SIZE*	17	19	21
ST - SEAT TUBE LENGTH**	430	480	530
TT - TOP TUBE LENGTH**	586	609	627
HT - HEAD TUBE LENGTH**	120	130	140
SA - SEAT TUBE ANGLE***	72,5	72,5	72,5
HA - HEAD TUBE ANGLE***	69	69	69
CS - CHAINSTAY LENGTH**	444	444	444
WB - WHEELBASE**	1095	1119	1138
REACH**	385	405	420
STACK**	636	646	655
BB DROP**	60	60	60

* dimension in inches, ** dimension in mm, *** dimension in degrees

HEXAGON BOOST ZZ



SKU	SIZE	COLOUR	FINISH
KRHBZZ29X17M004421	S	turquoise	gloss
KRHBZZ29X19M004422	M	turquoise	gloss
KRHBZZ29X21M004423	L	turquoise	gloss

GEAR RATIO 3 x 7

WHEEL DIAMETER 29"

COLOUR VARIANTS



FRAME

FRAME	ALUMINIUM
FORK	SR SUNTOUR XCE28
FORK TRAVEL	80 mm
SIZES	S(17"), M(19"), L(21")

DRIVETRAIN

FRONT DERAILLEUR	SHIMANO TOURNEY TY700
REAR DERAILLEUR	SHIMANO ACERA M360
FRONT BRAKE	POWER BH-M960
REAR BRAKE	POWER BH-M960
BRAKE LEVERS	POWER BH-M960
BRAKE DISCS	DISC (160 mm)
SHIFTERS	TS-39-7
CRANKSET	WHEEL TOP
SPROCKETS	42T-34T-24T/170 mm
BOTTOM BRACKET	FP-B902
CHAIN	YBN S8
CASSETTE/FREEWHEEL	SHIMANO TOURNEY MF-TZ500
CASSETTE/FREEWHEEL RANGE	14-28T

WHEELS

FRONT HUB	GL-B43F-DS
REAR HUB	ENGINE SHENGYI DGWH2S
RIMS	KROSS

COMPONENTS

HANDLEBAR	ALUMINIUM 680 mm 31.8
HANDLEBAR STEM	ALUMINIUM 75 mm/31,8/7°
SEAT POST	ALUMINIUM 27,2 x 300 mm
HEADSET	ALUMINIUM
SADDLE	KROSS
GRIPS	KROSS SCALE
PEDALS	FP-917N
BATTERY	BATTERY 360Wh 10Ah 36V
ENGINE	SHENGYI DGWH2S; REAR;
DISPLAY	SHENGYI LCD, ETD-21C LCD

GEOMETRY

SIZE	S	M	L
FS - FRAME SIZE*	17	19	21
ST - SEAT TUBE LENGTH**	430	480	530
TT - TOP TUBE LENGTH**	586	609	627
HT - HEAD TUBE LENGTH**	120	130	140
SA - SEAT TUBE ANGLE***	73	73	73
HA - HEAD TUBE ANGLE***	69	69	69
CS - CHAINSTAY LENGTH**	444	444	444
WB - WHEELBASE**	1095	1119	1138
REACH**	385	405	420
STACK**	636	646	655
BB DROP**	60	60	60

* dimension in inches, ** dimension in mm, *** dimension in degrees

LEA BOOST 5.0



GEAR RATIO 1 x 10
WHEEL DIAMETER 27,5"/29"
COLOUR VARIANTS



SKU	SIZE	COLOUR	FINISH
KRLB5Z27X15W004431	DXS/27,5"	purple-black	gloss
KRLB5Z29X18W004437	DS/29"	purple-black	gloss
KRLB5Z29X19W004438	DM/29"	purple-black	gloss

FRAME

FRAME	ALUMINIUM
FORK	X-FUSION MIG BOOST LO
FORK TRAVEL	120 mm
SIZES	DXS(15"), DS(18"), DM(19")

DRIVETRAIN

REAR DERAILLEUR	MICROSHIFT ADVENT M620S
FRONT BRAKE	SHIMANO MT200
REAR BRAKE	SHIMANO MT200
BRAKE LEVERS	SHIMANO MT200
BRAKE DISCS	SHIMANO RT30 (180 mm)
SHIFTERS	SL-950S-R
CRANKSET	FSA-CK751
SPROCKETS	38T/170 mm
CHAIN	YBN SH10
CASSETTE/FREEWHEEL	MICROSHIFT CS-H104
CASSETTE/FREEWHEEL RANGE	11-48T

WHEELS

FRONT HUB	GL-B93F-B/CL-X15 32H
REAR HUB	SHIMANO MT400-B
RIMS	KROSS

COMPONENTS

HANDLEBAR	ALUMINIUM 720 mm 31,8
HANDLEBAR STEM	ALUMINIUM 60 mm/31,8/3"
SEAT POST	ALUMINIUM 27,2 x 350 mm
HEADSET	ALUMINIUM
SADDLE	SELLE ITALIA X-BASE BOOST
GRIPS	KROSS SCALE
BATTERY	SIMPLO 504 WH
ENGINE	SHIMANO E7000
DISPLAY	SHIMANO SC-E7000

GEOMETRY

SIZE	DXS	DS	DM
FS - FRAME SIZE*	15	18	19
ST - SEAT TUBE LENGTH**	390	445	470
TT - TOP TUBE LENGTH**	580	590	600
HT - HEAD TUBE LENGTH**	125	120	130
SA - SEAT TUBE ANGLE***	73,5	73,5	73,5
HA - HEAD TUBE ANGLE***	68	68	68
CS - CHAINSTAY LENGTH**	435	460	460
WB - WHEELBASE**	1107	1148	1159
REACH**	393	402	409
STACK**	631	635	644
BB DROP**	55	55	55

* dimension in inches, ** dimension in mm, *** dimension in degrees

LEA BOOST 4.0



GEAR RATIO 1 x 9

WHEEL DIAMETER 29"

COLOUR VARIANTS



SKU	SIZE	COLOUR	FINISH
KRLB4Z29X16W004435	DS/29"	pearly-pink	gloss
KRLB4Z29X19W004436	DM/29"	pearly-pink	gloss

FRAME

FRAME	ALUMINIUM
FORK	SR SUNTOUR XCM ATB HLO
FORK TRAVEL	100 mm
SIZES	DS(16"), DM(19")

DRIVETRAIN

REAR DERAILLEUR	MICROSHIFT ADVENT M6195
FRONT BRAKE	POWER BH-M960
REAR BRAKE	POWER BH-M960
BRAKE LEVERS	POWER BH-M960
BRAKE DISCS	DISC (160 mm)
SHIFTERS	SL-M819-R
CRANKSET	BAFANG
SPROCKETS	38T/170 mm
CHAIN	YBN S9E
CASSETTE/FREEWHEEL	MICROSHIFT CS-H093
CASSETTE/FREEWHEEL RANGE	11-46T

WHEELS

FRONT HUB	GL-B43F-DS
REAR HUB	GL-B43R-DS
RIMS	KROSS

COMPONENTS

HANDLEBAR	ALUMINIUM 740 mm 31.8
HANDLEBAR STEM	ALUMINIUM 60 mm/31.8/3°
SEAT POST	ALUMINIUM 31,6 x 350 mm
HEADSET	ALUMINIUM
SADDLE	SELLE ITALIA X-BASE BOOST
GRIPS	KROSS SCALE
PEDALS	FP-917N
BATTERY	PATHFINDER BATTERY 730WH
ENGINE	BAFANG M400
DISPLAY	DISPLAY DP C11 CAN

GEOMETRY

SIZE	DS	DM
FS - FRAME SIZE*	16	19
ST - SEAT TUBE LENGTH**	410	470
TT - TOP TUBE LENGTH**	595	610
HT - HEAD TUBE LENGTH**	140	150
SA - SEAT TUBE ANGLE***	75	74
HA - HEAD TUBE ANGLE***	67	67
CS - CHAINSTAY LENGTH**	490	490
WB - WHEELBASE**	1201	1217
REACH**	416	429
STACK**	645	654
BB DROP**	60	60

* dimension in inches, ** dimension in mm, *** dimension in degrees

LEA BOOST 3.0



GEAR RATIO 1 x 8

WHEEL DIAMETER 29"

COLOUR VARIANTS



SKU	SIZE	COLOUR	FINISH
KRLB3Z29X16W004433	DS	turquoise-black	gloss
KRLB3Z29X19W004434	DM	turquoise-black	gloss

FRAME

FRAME	ALUMINIUM
FORK	SR SUNTOUR XCM ATB HLO
FORK TRAVEL	100 mm
SIZES	DS(16"), DM(19")

DRIVETRAIN

REAR DERAILLEUR	MICROSHIFT ACOLYTE M5185M
FRONT BRAKE	POWER BH-M960
REAR BRAKE	POWER BH-M960
BRAKE LEVERS	POWER BH-M960
BRAKE DISCS	DISC (160 mm)
SHIFTERS	SL-M7180-R
CRANKSET	BAFANG
SPROCKETS	38T/170 mm
CHAIN	YBN S8E
CASSETTE/FREEWHEEL	MICROSHIFT CS-H083
CASSETTE/FREEWHEEL RANGE	11-42T

WHEELS

FRONT HUB	GL-B43F-DS
REAR HUB	GL-B43R-DS
RIMS	KROSS

COMPONENTS

HANDLEBAR	ALUMINIUM 740 mm 31.8
HANDLEBAR STEM	ALUMINIUM 60 mm/31.8/3°
SEAT POST	ALUMINIUM 31,6 x 350 mm
HEADSET	ALUMINIUM
SADDLE	SELLE ITALIA X-BASE BOOST
GRIPS	KROSS SCALE
PEDALS	FP-917N
BATTERY	PATHFINDER BATTERY 576WH
ENGINE	BAFANG M400
DISPLAY	DISPLAY DP C11 CAN

GEOMETRY

SIZE	DS	DM
FS - FRAME SIZE*	16	19
ST - SEAT TUBE LENGTH**	410	470
TT - TOP TUBE LENGTH**	595	610
HT - HEAD TUBE LENGTH**	140	150
SA - SEAT TUBE ANGLE***	75	74
HA - HEAD TUBE ANGLE***	67	67
CS - CHAINSTAY LENGTH**	490	490
WB - WHEELBASE**	1201	1217
REACH**	416	429
STACK**	645	654
BB DROP**	60	60

* dimension in inches, ** dimension in mm, *** dimension in degrees

LEA BOOST 2.0



SKU	SIZE	COLOUR	FINISH
KRLB2Z27X16W001775	DXS/27,5"	blue	gloss
KRLB2Z29X17W001776	DS/29"	blue	gloss
KRLB2Z29X19W001777	DM/29"	blue	gloss

GEAR RATIO 1 x 8
WHEEL DIAMETER 27,5"/29"
COLOUR VARIANTS



FRAME

FRAME	ALUMINIUM
FORK	SR SUNTOUR XCM ATB HLO
FORK TRAVEL	100 mm
SIZES	DXS(16"), DS(17"), DM(19")

DRIVETRAIN

REAR DERAILLEUR	MICROSHIFT ACOLYTE
FRONT BRAKE	POWER BH-M960
REAR BRAKE	POWER BH-M960
BRAKE LEVERS	POWER BH-M960
BRAKE DISCS	POWER RT600 160 6B
SHIFTERS	MICROSHIFT ACOLYTE
CRANKSET	WHEEL TOP
SPROCKETS	38T/175 mm
BOTTOM BRACKET	ROTATION SENSOR
CHAIN	YBN E-BIKE
CASSETTE/FREEWHEEL	MICROSHIFT CS-H083
CASSETTE/FREEWHEEL RANGE	11-42T

WHEELS

FRONT HUB	GL-B43F-DS
RIMS	KROSS

COMPONENTS

HANDLEBAR	ALUMINIUM 680 mm 31.8
HANDLEBAR STEM	ALUMINIUM 60 mm/31,8/3°
SEAT POST	ALUMINIUM 27,2 x 350 mm
HEADSET	FP-H816 O1-1/8"
SADDLE	SELLE ITALIA X-BASE BOOST
GRIPS	KROSS SCALE
PEDALS	FP-917N
BATTERY	HYENA GIRAFFE 360 Wh
ENGINE	HYENA MRC-250
DISPLAY	HYENA CROCO H

GEOMETRY

SIZE	DXS	DS	DM
FS - FRAME SIZE*	16	17	19
ST - SEAT TUBE LENGTH**	390	445	470
TT - TOP TUBE LENGTH**	575	590	600
HT - HEAD TUBE LENGTH**	135	130	140
SA - SEAT TUBE ANGLE***	73,5	73,5	73,5
HA - HEAD TUBE ANGLE***	68	68	68
CS - CHAINSTAY LENGTH**	445	460	460
WB - WHEELBASE**	1111	1143	1154
REACH**	392	401	408
STACK**	616	639	648
BB DROP**	45	55	55

* dimension in inches, ** dimension in mm, *** dimension in degrees

LEA BOOST 1.0



FRAME

FRAME	ALUMINIUM
FORK	SR SUNTOUR XCT30 HLO
FORK TRAVEL	100 mm
SIZES	DXS(16"), DS(17")

DRIVETRAIN

FRONT DERAILLEUR	SHIMANO TOURNEY TY700
REAR DERAILLEUR	SHIMANO ACERA M360
FRONT BRAKE	SHIMANO ALTUS ST-EF505
REAR BRAKE	SHIMANO MT200
BRAKE LEVERS	SHIMANO ALTUS ST-EF505
BRAKE DISCS	DISC (160 mm)
SHIFTERS	SHIMANO EF505
CRANKSET	PROWHEEL BURNER-301-N
SPROCKETS	42T-32T-22T/170 mm
BOTTOM BRACKET	BAFANG
CHAIN	YBN S8
CASSETTE/FREEWHEEL	SHIMANO HG200
CASSETTE/FREEWHEEL RANGE	12-32T

WHEELS

FRONT HUB	GL-B43F-DS
REAR HUB	BAFANG G120.250.DC
RIMS	KROSS

COMPONENTS

HANDLEBAR	ALUMINIUM 680 mm 31.8
HANDLEBAR STEM	ALUMINIUM 75 mm/31,8/7°
SEAT POST	ALUMINIUM 27,2 x 350 mm
HEADSET	FP-H816 O1-1/8"
SADDLE	KROSS
GRIPS	KROSS SCALE
PEDALS	FP-917N
BATTERY	PHYLION SF-06S 522 Wh
ENGINE	BAFANG G120.250.DC
DISPLAY	BAFANG HMI DP E12.CANBUS

GEOMETRY

SIZE	DXS	DS
FS - FRAME SIZE*	16	17
ST - SEAT TUBE LENGTH**	407	432
TT - TOP TUBE LENGTH**	569	581
HT - HEAD TUBE LENGTH**	110	115
SA - SEAT TUBE ANGLE***	73	73
HA - HEAD TUBE ANGLE***	70	70
CS - CHAINSTAY LENGTH**	435	150
WB - WHEELBASE**	1051	1101
REACH**	387	395
STACK**	595	612
BB DROP**	35	35

* dimension in inches, ** dimension in mm, *** dimension in degrees

SKU	SIZE	COLOUR	FINISH
KRLB1Z27X16W003377	DXS/27,5"	black-celadon	mat
KRLB1Z29X17W003378	DS/29"	black-celadon	mat

GEAR RATIO 3 x 8
WHEEL DIAMETER 27,5"/29"
COLOUR VARIANTS



LEA BOOST ZZ



SKU	SIZE	COLOUR	FINISH
KRLBZZ27X16W005238	DXS/27,5"	black-pink	gloss
KRLBZZ29X17W005239	DS/29"	black-pink	gloss

GEAR RATIO 3 x 7

WHEEL DIAMETER 27,5"

COLOUR VARIANTS



FRAME

FRAME	ALUMINIUM
FORK	SR SUNTOUR XCE28
FORK TRAVEL	80 mm
SIZES	DXS(16"), DS(17")

DRIVETRAIN

FRONT DERAILLEUR	SHIMANO TOURNEY TY700
REAR DERAILLEUR	SHIMANO ACERA M360
FRONT BRAKE	POWER BH-M960
REAR BRAKE	POWER BH-M960
BRAKE LEVERS	POWER BH-M960
BRAKE DISCS	DISC (160 mm)
SHIFTERS	TS-39-7
CRANKSET	PROWHEEL TA-CM68
SPROCKETS	42T-34T-24T/170 mm
BOTTOM BRACKET	FP-B902
CHAIN	YBN S50
CASSETTE/FREEWHEEL	SHIMANO TOURNEY MF-TZ500
CASSETTE/FREEWHEEL RANGE	14-28T

WHEELS

FRONT HUB	GL-B43F-DS
REAR HUB	GL-B43R-DS
RIMS	KROSS

COMPONENTS

HANDLEBAR	ALUMINIUM 680 mm 31.8
HANDLEBAR STEM	ALUMINIUM 75 mm/31,8/7°
SEAT POST	ALUMINIUM 27,2 x 300 mm
HEADSET	ALUMINIUM
SADDLE	KROSS
GRIPS	KROSS SCALE
PEDALS	FP-917N
BATTERY	PHYLION SF-06S 522 Wh
ENGINE	SHENGYI DGWH2S; REAR;
DISPLAY	SHENGYI LCD, ETD-21C LCD

GEOMETRY

SIZE	DXS	DS
FS - FRAME SIZE*	16	17
ST - SEAT TUBE LENGTH**	407	432
TT - TOP TUBE LENGTH**	569	581
HT - HEAD TUBE LENGTH**	110	115
SA - SEAT TUBE ANGLE***	73	73
HA - HEAD TUBE ANGLE***	70	70
CS - CHAINSTAY LENGTH**	435	450
WB - WHEELBASE**	1051	1101
REACH**	387	395
STACK**	595	612
BB DROP**	35	35

* dimension in inches, ** dimension in mm, *** dimension in degrees

E-TREKKING BIKES

TRANS HYBRID

Best for daily commutes to work and weekend getaways outside the city.

Full control thanks to the modern geometry that ensures a more confident riding position.

More comfortable than ever, thanks to wide tires and suspension.

Ready for any weather and time of day with full mudguards and powerful lighting.





TRANS HYBRID PRESTIGE



GEAR RATIO 1 x 11

WHEEL DIAMETER 28"

COLOUR VARIANTS



SKU	SIZE	COLOUR	FINISH
KRTHPR28X22M005669	L	black	gloss

FRAME

FRAME	ALUMINIUM
FORK	SUNTOUR MOBIE25-AIR-LOR-DS.
FORK TRAVEL	63 mm
SIZES	L(57"), XL(61")

DRIVETRAIN

REAR DERAILLEUR	SHIMANO XT D12 RD-M8050-GS
FRONT BRAKE	SHIMANO XT M8100
REAR BRAKE	SHIMANO DEORE XT M8100
BRAKE LEVERS	SHIMANO DEORE XT M8100
BRAKE DISCS	SHIMANO XT MT800-S (160 MM)
SHIFTERS	SHIMANO DEORE XT M8050-R D12
CRANKSET	SHIMANO DEORE XT FC-E8000
SPROCKETS	38T/170 mm
CHAIN	SHIMANO CN-E8000
CASSETTE/FREEWHEEL	SHIMANO SLX CS-M7000
CASSETTE/FREEWHEEL RANGE	11-42T

WHEELS

FRONT HUB	SHIMANO HB-M8010
REAR HUB	SHIMANO XT FH-M8000
RIMS	RYDE ANDRA 321
TIRES	VREDESTEIN PERFECT 28 x 1,75

COMPONENTS

HANDLEBAR	ALUMINIUM
HANDLEBAR STEM	SATORI UP3E 110/31,8 REG
SEAT POST	AMORTIZED 31,6 x 350 mm
HEADSET	FSA ORBIT C-40-ACB TAPERED
SADDLE	SELLE ROYAL E-ZONE MODERATE US
GRIPS	VELO
PEDALS	FP-210
CARRIER	ATRAN VELO ALUMINIUM
FRONT LIGHT	B&M IQ-X DYNAMO/EBIKE
REAR LIGHT	SPANNINGA PIMENTO DYNAMO/EBIKE
MUDGUARDS	PLETSCHER H60 ALUMINIUM
KICK STAND	ATRAN VELO
BATTERY	SIMPLO 504 WH
ENGINE	SHIMANO E6110
DISPLAY	SHIMANO SC-E6100

GEOMETRY

SIZE	L	XL
FS - FRAME SIZE*	57	61
ST - SEAT TUBE LENGTH**	570	610
TT - TOP TUBE LENGTH**	602	608
HT - HEAD TUBE LENGTH**	170	190
SA - SEAT TUBE ANGLE***	72	72
HA - HEAD TUBE ANGLE***	72	72
CS - CHAINSTAY LENGTH**	470	470
WB - WHEELBASE**	1095	1101
REACH**	391	391
STACK**	650	669
BB DROP**	65	65

* dimension in inches, ** dimension in mm, *** dimension in degrees

TRANS HYBRID PRESTIGE



SKU	SIZE	COLOUR	FINISH
KRTHPR28X19W005661	DS	purple	gloss
KRTHPR28X19W005666	DS	purple	gloss
KRTHPR28X20W005662	DM	purple	gloss

GEAR RATIO 1 x 11

WHEEL DIAMETER 28"

COLOUR VARIANTS



FRAME

FRAME	ALUMINIUM
FORK	SUNTOUR MOBIE25-AIR-LOR-DS.
FORK TRAVEL	63 mm
SIZES	DS(19"), DM(20")

DRIVETRAIN

REAR DERAILLEUR	SHIMANO XT D12 RD-M8050-GS
FRONT BRAKE	SHIMANO XT M8100
REAR BRAKE	SHIMANO-1'DEORE XT M8100
BRAKE LEVERS	SHIMANO-1'DEORE XT M8100
BRAKE DISCS	SHIMANO XT MT800-S (160 mm)
SHIFTERS	SHIMANO DEORE XT M8050-R D12
CRANKSET	SHIMANO DEORE XT FC-E8000
SPROCKETS	38T/170 mm
BOTTOM BRACKET	
CHAIN	SHIMANO CN-E8000
CASSETTE/FREEWHEEL	SHIMANO SLX CS-M7000
CASSETTE/FREEWHEEL RANGE	11-42T

WHEELS

FRONT HUB	SHIMANO HB-M8010
REAR HUB	SHIMANO XT FH-M8000
RIMS	RYDE ANDRA 321
TIRES	VREDESTEIN PERFECT 28 x 1,75

COMPONENTS

HANDLEBAR	ALUMINIUM
HANDLEBAR STEM	SATORI UP3E 110/31,8 REG
SEAT POST	AMORTIZED 31,6 x 350 mm
HEADSET	FSA ORBIT C-40-ACB TAPERED
SADDLE	SELLE ROYAL E-ZONE MODERATE US
GRIPS	VELO
PEDALS	FP-210
CARRIER	ATRAN VELO ALUMINIUM
FRONT LIGHT	B&M IG-X DYNAMO/EBIKE
REAR LIGHT	SPANNINGA PIMENTO DYNAMO/EBIKE
MUDGUARDS	PLETSCHER H60 ALUMINIUM
KICK STAND	ATRAN VELO
BATTERY	SIMPLO 630 WH
ENGINE	SHIMANO E6110
DISPLAY	SHIMANO SC-E6100

GEOMETRY

SIZE	DS	DM
FS - FRAME SIZE*	19	20
ST - SEAT TUBE LENGTH**	490	530
TT - TOP TUBE LENGTH**	592	596
HT - HEAD TUBE LENGTH**	160	170
SA - SEAT TUBE ANGLE***	72	72
HA - HEAD TUBE ANGLE***	72	72
CS - CHAINSTAY LENGTH**	470	470
WB - WHEELBASE**	1085	1089
REACH**	384	385
STACK**	640	650
BB DROP**	65	65

* dimension in inches, ** dimension in mm, *** dimension in degrees

TRANS HYBRID LS 5.0



SKU	SIZE	COLOUR	FINISH
KRTHS528X18U001094	M	white-silver	gloss
KRTHS528X20U001095	L	white-silver	gloss
KRTHS528X22U001096	XL	white-silver	gloss
KRTHS528X18U001097	M	silver-black	gloss
KRTHS528X20U001098	L	silver-black	gloss
KRTHS528X22U001099	XL	silver-black	gloss

GEAR RATIO 1 x 9

WHEEL DIAMETER 28"

COLOUR VARIANTS



FRAME

FRAME	ALUMINIUM PERFORMANCE
FORK	SR SUNTOUR NEX E25
FORK TRAVEL	63 mm
SIZES	M(18"), L(20"), XL(22")

DRIVETRAIN

REAR DERAILLEUR	MICROSHIFT ADVENT M619
FRONT BRAKE	SHIMANO MT200
REAR BRAKE	SHIMANO MT200
BRAKE LEVERS	SHIMANO MT200
BRAKE DISCS	DISC (160 mm)
SHIFTERS	MICROSHIFT ADVENT
CRANKSET	SHIMANO STEPS
SPROCKETS	38T/170 mm
CHAIN	YBN S9E
CASSETTE/FREEWHEEL	MICROSHIFT CS-H093
CASSETTE/FREEWHEEL RANGE	11-42T

WHEELS

FRONT HUB	SHIMANO ACERA M3050
REAR HUB	SHIMANO ACERA M3050
RIMS	KROSS
TIRES	SCHWALBE ROAD CRUISER 28 x 1,75

COMPONENTS

HANDLEBAR	ALUMINIUM 660 mm 31,8
HANDLEBAR STEM	ALUMINIUM 90 mm/31,8 REG
SEAT POST	ALUMINIUM 31,6 x 350 mm
HEADSET	FP-H856B2;1-1/8"-1.5"
SADDLE	SELLE ROYAL LOOKIN RVS MOD W
GRIPS	HERRMANS ADRENALIN
PEDALS	FP-210ZU
CARRIER	STANDWELL ALUMINIUM - 25 kg
FRONT LIGHT	BUHEL SHINY DYNAMO/EBIKE
REAR LIGHT	HERRMANS H-CARGO EBIKE
MUDGUARDS	HEBIE
KICK STAND	URSUS BOCZNA
BATTERY	SIMPLO 630 WH
ENGINE	SHIMANO E5000
DISPLAY	SHIMANO SC-E6100C

GEOMETRY

SIZE	M	L	XL
FS - FRAME SIZE*	18	20	22
ST - SEAT TUBE LENGTH**	460	508	560
TT - TOP TUBE LENGTH**	567	571	580
HT - HEAD TUBE LENGTH**	180	190	200
SA - SEAT TUBE ANGLE***	74	74	74
HA - HEAD TUBE ANGLE***	68,5	68,5	68,5
CS - CHAINSTAY LENGTH**	454	454	454
WB - WHEELBASE**	1113	1118	1128
REACH**	379	380	386
STACK**	657	667	676
BB DROP**	60	60	60

* dimension in inches, ** dimension in mm, *** dimension in degrees

TRANS HYBRID LS 3.0



SKU	SIZE	COLOUR	FINISH
KRTHS328X18U001106	M	ruby red-silver	gloss
KRTHS328X20U001107	L	ruby red-silver	gloss
KRTHS328X22U001108	XL	ruby red-silver	gloss
KRTHS328X18U001109	M	blue-black	gloss
KRTHS328X20U001110	L	blue-black	gloss
KRTHS328X22U001111	XL	blue-black	gloss

GEAR RATIO 1 x 8

WHEEL DIAMETER 28"

COLOUR VARIANTS



FRAME

FRAME	ALUMINIUM PERFORMANCE
FORK	SR SUNTOUR NEX E25
FORK TRAVEL	63 mm
SIZES	M(18"), L(20"), XL(22")

DRIVETRAIN

REAR DERAILLEUR	MICROSHIFT ACOLYTE M5180M
FRONT BRAKE	POWER BH-M960
REAR BRAKE	POWER BH-M960
BRAKE LEVERS	POWER BH-M960
BRAKE DISCS	DISC (160 mm)
SHIFTERS	MICROSHIFT ACOLYTE
CRANKSET	SHIMANO STEPS
SPROCKETS	38T/170 mm
CHAIN	YBN S8E
CASSETTE/FREEWHEEL	SHIMANO ALTUS HG31
CASSETTE/FREEWHEEL RANGE	11-32T

WHEELS

FRONT HUB	GL-B43F-DS
REAR HUB	GL-B43F-DS
RIMS	KROSS
TIRES	WANDA G5001 28 x 1,75

COMPONENTS

HANDLEBAR	ALUMINIUM 660 mm 31,8
HANDLEBAR STEM	ALUMINIUM 90 mm/31,8 REG
SEAT POST	ALUMINIUM 31,6 x 350 mm
HEADSET	FP-H856B2;1-1/8"-1.5"
SADDLE	YIBOTONG YBT-K607
GRIPS	HERRMANS ADRENALIN
PEDALS	FP-210ZU
CARRIER	STANDWELL ALUMINIUM - 25 kg
FRONT LIGHT	BUHEL SHINY DYNAMO/EBIKE
REAR LIGHT	HERRMANS H-CARGO EBIKE
MUDGUARDS	HEBIE
KICK STAND	URSUS BOCZNA
BATTERY	SIMPLO 504 WH
ENGINE	SHIMANO E5000
DISPLAY	SHIMANO SC-E6100C

GEOMETRY

SIZE	M	L	XL
FS - FRAME SIZE*	18	20	22
ST - SEAT TUBE LENGTH**	460	508	560
TT - TOP TUBE LENGTH**	567	571	580
HT - HEAD TUBE LENGTH**	180	190	200
SA - SEAT TUBE ANGLE***	74	74	74
HA - HEAD TUBE ANGLE***	68,5	68,5	68,5
CS - CHAINSTAY LENGTH**	454	454	454
WB - WHEELBASE**	1113	1118	1128
REACH**	379	380	386
STACK**	657	667	676
BB DROP**	60	60	60

* dimension in inches, ** dimension in mm, *** dimension in degrees

TRANS HYBRID LS 1.0



SKU	SIZE	COLOUR	FINISH
KRTHS128X17U004957	S	blue-white	gloss
KRTHS128X19U004958	M	blue-white	gloss
KRTHS128X17U004959	S	pearly-black	gloss
KRTHS128X19U004960	M	pearly-black	gloss

GEAR RATIO 3 x 8

WHEEL DIAMETER 28"

COLOUR VARIANTS



FRAME

FRAME	ALUMINIUM PERFORMANCE
FORK	SR SUNTOUR NEX E25
FORK TRAVEL	63 mm
SIZES	S(17")

DRIVETRAIN

REAR DERAILLEUR	MICROSHIFT ACOLYTE M5185M
FRONT BRAKE	POWER BH-M960
REAR BRAKE	POWER BH-M960
BRAKE LEVERS	POWER BH-M960
BRAKE DISCS	POWER
SHIFTERS	MICROSHIFT MEZZO
CRANKSET	PROWHEEL RPL-FD16SG-F
SPROCKETS	48T-38T-28T/170 mm
BOTTOM BRACKET	HYENA
CHAIN	YBN E-BIKE
CASSETTE/FREEWHEEL	SHIMANO ALTUS HG31
CASSETTE/FREEWHEEL RANGE	11-32T

WHEELS

FRONT HUB	GL
REAR HUB	ENGINE HYENA
RIMS	KROSS
TIRES	WANDA G5001 28 x 1,75

COMPONENTS

HANDLEBAR	ALUMINIUM 660 mm 31,8
HANDLEBAR STEM	ALUMINIUM 90 mm/31,8 REG
SEAT POST	ALUMINIUM 31,6 x 350 mm
HEADSET	ALUMINIUM
SADDLE	YIBOTONG YBT-K607
GRIPS	ADRENALIN
PEDALS	FP-210ZU
CARRIER	STANDWELL ALUMINIUM 28" 25 kg
FRONT LIGHT	HERRMANS H-IKE BATTERY
REAR LIGHT	AXA JUNO BATTERY
MUDGUARDS	HEBIE
KICK STAND	REAR ADJ. KICKSTAND "KING" BCK
BATTERY	HYENA GIRAFFE
ENGINE	HYENA MRC-250
DISPLAY	HYENA LCD COMPACT EX

GEOMETRY

SIZE	S
FS - FRAME SIZE*	17
ST - SEAT TUBE LENGTH**	430
TT - TOP TUBE LENGTH**	551
HT - HEAD TUBE LENGTH**	155
SA - SEAT TUBE ANGLE***	74
HA - HEAD TUBE ANGLE***	68
CS - CHAINSTAY LENGTH**	460
WB - WHEELBASE**	1102
REACH**	371
STACK**	625
BB DROP**	60

* dimension in inches, ** dimension in mm, *** dimension in degrees

TRANS HYBRID 6.0



SKU	SIZE	COLOUR	FINISH
KRTH6Z28X17M004815	S	black-graphite	gloss
KRTH6Z28X19M004816	M	black-graphite	gloss
KRTH6Z28X21M004817	L	black-graphite	gloss
KRTH6Z28X23M004818	XL	black-graphite	gloss

GEAR RATIO 1 x 10

WHEEL DIAMETER 28"

COLOUR VARIANTS



FRAME

FRAME	ALUMINIUM PERFORMANCE
FORK	ROCK SHOX PARAGON GOLD
FORK TRAVEL	65 mm
SIZES	S(17"), M(19"), L(21"), XL(23")

DRIVETRAIN

REAR DERAILLEUR	SHIMANO DEORE XT T8000
FRONT BRAKE	SHIMANO MT410
REAR BRAKE	SHIMANO MT410
BRAKE LEVERS	SHIMANO T402
BRAKE DISCS	SHIMANO RT30 (180)
SHIFTERS	SHIMANO DEORE M6000
CRANKSET	SHIMANO FC-E6100
SPROCKETS	38T/170 mm
CHAIN	SHIMANO E6090
CASSETTE/FREEWHEEL	SHIMANO GRX RX400 HG500
CASSETTE/FREEWHEEL RANGE	11-32T

WHEELS

FRONT HUB	SHIMANO ACERA M3050
REAR HUB	SHIMANO ACERA M3050
RIMS	KROSS
TIRES	SCHWALBE MARATHON 28 x 1,75

COMPONENTS

HANDLEBAR	ALUMINIUM 640 mm 31.8
HANDLEBAR STEM	ALUMINIUM 90 mm/31.8 REG
SEAT POST	ALUMINIUM 27,2 x 300 mm
HEADSET	FP-H856B2;1-1/8"-1.5"
SADDLE	SELLE ROYAL LOOKIN RVS MOD M
GRIPS	HERRMANS ADRENALIN
PEDALS	FP-210ZU
CARRIER	STANDWELL ALUMINIUM - 25 kg
FRONT LIGHT	BUHEL SHINY DYNAMO/EBIKE
REAR LIGHT	HERRMANS H-CARGO EBIKE
MUDGUARDS	TUBUS
KICK STAND	URSUS BOCZNA
BATTERY	SIMPLO 630 WH
ENGINE	SHIMANO E6110
DISPLAY	SHIMANO SC-E6100C

GEOMETRY

SIZE	S	M	L	XL
FS - FRAME SIZE*	17	19	21	23
ST - SEAT TUBE LENGTH**	430	480	530	580
TT - TOP TUBE LENGTH**	575	585	605	630
HT - HEAD TUBE LENGTH**	140	140	140	160
SA - SEAT TUBE ANGLE***	74	74	74	74
HA - HEAD TUBE ANGLE***	69	70	70	70
CS - CHAINSTAY LENGTH**	450	450	450	450
WB - WHEELBASE**	1112	1111	1131	1157
REACH**	397	405	425	445
STACK**	622	627	627	646
BB DROP**	60	60	60	60

* dimension in inches, ** dimension in mm, *** dimension in degrees

TRANS HYBRID 6.0



GEAR RATIO 1 x 10
WHEEL DIAMETER 28"
COLOUR VARIANTS



SKU	SIZE	COLOUR	FINISH
KRTH6Z28X17W004813	DM	black-graphite	gloss
KRTH6Z28X19W004814	DL	black-graphite	gloss

FRAME

FRAME	ALUMINIUM PERFORMANCE
FORK	ROCK SHOX PARAGON GOLD
FORK TRAVEL	65 mm
SIZES	DM(17"), DL(19")

DRIVETRAIN

REAR DERAILLEUR	SHIMANO DEORE XT T8000
FRONT BRAKE	SHIMANO MT410
REAR BRAKE	SHIMANO MT410
BRAKE LEVERS	SHIMANO T402
BRAKE DISCS	SHIMANO RT30 (180)
SHIFTERS	SHIMANO DEORE M6000
CRANKSET	SHIMANO FC-E6100
SPROCKETS	38T/170 mm
CHAIN	SHIMANO E6090
CASSETTE/FREEWHEEL	SHIMANO GRX RX400 HG500
CASSETTE/FREEWHEEL RANGE	11-32T

WHEELS

FRONT HUB	SHIMANO ACERA M3050
REAR HUB	SHIMANO ACERA M3050
RIMS	KROSS
TIRES	SCHWALBE MARATHON 28 x 1,75

COMPONENTS

HANDLEBAR	ALUMINIUM 640 mm 31.8
HANDLEBAR STEM	ALUMINIUM 90 mm/31.8 REG
SEAT POST	ALUMINIUM 27,2 x 300 mm
HEADSET	FP-H856B2;1-1/8"-1.5"
SADDLE	SELLE ROYAL LOOKIN RVS MOD W
GRIPS	HERRMANS ADRENALIN
PEDALS	FP-210ZU
CARRIER	STANDWELL ALUMINIUM - 25 kg
FRONT LIGHT	BUHEL SHINY DYNAMO/EBIKE
REAR LIGHT	HERRMANS H-CARGO EBIKE
MUDGUARDS	TUBUS
KICK STAND	URSUS BOCZNA
BATTERY	SIMPLO 630 WH
ENGINE	SHIMANO E6110
DISPLAY	SHIMANO SC-E6100C

GEOMETRY

SIZE	DM	DL
FS - FRAME SIZE*	17	19
ST - SEAT TUBE LENGTH**	430	480
TT - TOP TUBE LENGTH**	575	585
HT - HEAD TUBE LENGTH**	140	140
SA - SEAT TUBE ANGLE***	74	74
HA - HEAD TUBE ANGLE***	69	70
CS - CHAINSTAY LENGTH**	454	450
WB - WHEELBASE**	1112	1111
REACH**	397	405
STACK**	622	627
BB DROP**	60	60

* dimension in inches, ** dimension in mm, *** dimension in degrees

TRANS HYBRID 4.0



SKU	SIZE	COLOUR	FINISH
KRTH4Z28X17M004821	S	black	mat
KRTH4Z28X19M004822	M	black	mat
KRTH4Z28X21M004823	L	black	mat
KRTH4Z28X23M004824	XL	black	mat

GEAR RATIO 1 x 9

WHEEL DIAMETER 28"

COLOUR VARIANTS



FRAME

FRAME	ALUMINIUM PERFORMANCE
FORK	SR SUNTOUR NEX E25
FORK TRAVEL	63 mm
SIZES	S(17"), M(19"), L(21"), XL(23")

DRIVETRAIN

REAR DERAILLEUR	SHIMANO ACERA T3000
FRONT BRAKE	SHIMANO MT200
REAR BRAKE	SHIMANO MT200
BRAKE LEVERS	SHIMANO MT200
BRAKE DISCS	SHIMANO RT10 (180)
SHIFTERS	SHIMANO ALIVIO M3100
CRANKSET	SHIMANO FC-E6100
SPROCKETS	38T/170 mm
CHAIN	SHIMANO E6070
CASSETTE/FREEWHEEL	SHIMANO ALTUS HG200
CASSETTE/FREEWHEEL RANGE	11-32T

WHEELS

FRONT HUB	SHIMANO ACERA M3050
REAR HUB	SHIMANO ACERA M3050
RIMS	KROSS
TIRES	WANDA G5001 28 x 1,75

COMPONENTS

HANDLEBAR	ALUMINIUM 640 mm 31.8
HANDLEBAR STEM	ALUMINIUM 90 mm/31.8 REG
SEAT POST	ALUMINIUM 27,2 x 300 mm
HEADSET	FP-H856B2;1-1/8"-1.5"
SADDLE	SELLE ROYAL LOOKIN RVS MOD M
GRIPS	HERRMANS ADRENALIN
PEDALS	FP-210ZU
CARRIER	STANDWELL ALUMINIUM - 25 kg
FRONT LIGHT	LED SHINY 40LUX
REAR LIGHT	HERRMANS H-CARGO
MUDGUARDS	TUBUS
KICK STAND	URSUS BOCZNA
BATTERY	SIMPLO 504 WH
ENGINE	SHIMANO E6110
DISPLAY	SHIMANO SC-E6100C

GEOMETRY

SIZE	S	M	L	XL
FS - FRAME SIZE*	17	19	21	23
ST - SEAT TUBE LENGTH**	430	480	530	580
TT - TOP TUBE LENGTH**	575	585	605	630
HT - HEAD TUBE LENGTH**	140	140	140	160
SA - SEAT TUBE ANGLE***	74	74	74	74
HA - HEAD TUBE ANGLE***	69	70	70	70
CS - CHAINSTAY LENGTH**	450	450	450	450
WB - WHEELBASE**	1112	1111	1131	1157
REACH**	397	405	425	445
STACK**	622	627	627	646
BB DROP**	60	60	60	60

* dimension in inches, ** dimension in mm, *** dimension in degrees

TRANS HYBRID 4.0



GEAR RATIO 1 x 9

WHEEL DIAMETER 28"

COLOUR VARIANTS



SKU	SIZE	COLOUR	FINISH
KRTH4Z28X17W004819	DM	grey-blue	gloss
KRTH4Z28X19W004820	DL	grey-blue	gloss

FRAME

FRAME	ALUMINIUM PERFORMANCE
FORK	SR SUNTOUR NEX E25
FORK TRAVEL	63 mm
SIZES	DM(17"), DL(19")

DRIVETRAIN

REAR DERAILLEUR	SHIMANO ACERA T3000
FRONT BRAKE	SHIMANO MT200
REAR BRAKE	SHIMANO MT200
BRAKE LEVERS	SHIMANO MT200
BRAKE DISCS	SHIMANO RT10 (180)
SHIFTERS	SHIMANO ALIVIO M3100
CRANKSET	SHIMANO FC-E6100
SPROCKETS	38T/170 mm
CHAIN	SHIMANO E6070
CASSETTE/FREEWHEEL	SHIMANO ALTUS HG200
CASSETTE/FREEWHEEL RANGE	11-32T

WHEELS

FRONT HUB	SHIMANO ACERA M3050
REAR HUB	SHIMANO ACERA M3050
RIMS	KROSS
TIRES	WANDA G5001 28 x 1,75

COMPONENTS

HANDLEBAR	ALUMINIUM 640 mm 31.8
HANDLEBAR STEM	ALUMINIUM 90 mm/31.8 REG
SEAT POST	ALUMINIUM 27,2 x 300 mm
HEADSET	FP-H856B2;1-1/8"-1.5"
SADDLE	SELLE ROYAL LOOKIN RVS MOD W
GRIPS	HERRMANS ADRENALIN
PEDALS	FP-210ZU
CARRIER	STANDWELL ALUMINIUM - 25 kg
FRONT LIGHT	BUHEL SHINY DYNAMO/EBIKE
REAR LIGHT	HERRMANS H-CARGO EBIKE
MUDGUARDS	TUBUS
KICK STAND	URSUS BOCZNA
BATTERY	SIMPLO 504 WH
ENGINE	SHIMANO E6110
DISPLAY	SHIMANO SC-E6100C

GEOMETRY

SIZE	DM	DL
FS - FRAME SIZE*	17	19
ST - SEAT TUBE LENGTH**	430	480
TT - TOP TUBE LENGTH**	575	585
HT - HEAD TUBE LENGTH**	140	140
SA - SEAT TUBE ANGLE***	74	74
HA - HEAD TUBE ANGLE***	69	70
CS - CHAINSTAY LENGTH**	454	450
WB - WHEELBASE**	1112	1111
REACH**	397	405
STACK**	622	627
BB DROP**	60	60

* dimension in inches, ** dimension in mm, *** dimension in degrees

TRANS HYBRID 2.0



GEAR RATIO 1 x 9

WHEEL DIAMETER 28"

COLOUR VARIANTS



SKU	SIZE	COLOUR	FINISH
KRTH2Z28X18M004956	M	khaki-white	gloss
KRTH2Z28X21M004478	L	khaki-white	gloss

FRAME

FRAME	ALUMINIUM
FORK	SR SUNTOUR NEX E25
FORK TRAVEL	63 mm
SIZES	M(18")

DRIVETRAIN

REAR DERAILLEUR	SHIMANO ALIVIO M3100
FRONT BRAKE	POWER BH-M960
REAR BRAKE	POWER BH-M960
BRAKE LEVERS	POWER BH-M960
BRAKE DISCS	SHIMANO ALIVIO M3100
SHIFTERS	SHIMANO ALIVIO M3100
CRANKSET	BAFANG
SPROCKETS	38T/170 mm
CHAIN	SHIMANO E6070
CASSETTE/FREEWHEEL	SHIMANO ALTUS HG201
CASSETTE/FREEWHEEL RANGE	11-36T

WHEELS

FRONT HUB	GL-B43F-DS
REAR HUB	GL-B43R-DS
RIMS	KROSS
TIRES	WANDA G5001 28 x 1,75

COMPONENTS

HANDLEBAR	ALUMINIUM 640 mm 31.8
HANDLEBAR STEM	ALUMINIUM 90 mm/31.8 REG
SEAT POST	ALUMINIUM 27,2 x 350 mm
HEADSET	ALUMINIUM
SADDLE	YIBOTONG YBT-K607
GRIPS	HERRMANS
PEDALS	FP-210ZU
CARRIER	STANDWELL ALUMINIUM 28" 25 kg
FRONT LIGHT	HERRMANS H-IKE BATTERY
REAR LIGHT	BUHEL TIVOLI BATTERY
MUDGUARDS	TUBUS
KICK STAND	URSUS
BATTERY	PATHFINDER BATTERY 730WH
ENGINE	BAFANG G330.250
DISPLAY	DISPLAY DP C11 CAN

GEOMETRY

SIZE	M
FS - FRAME SIZE*	18
ST - SEAT TUBE LENGTH**	460
TT - TOP TUBE LENGTH**	605
HT - HEAD TUBE LENGTH**	140
SA - SEAT TUBE ANGLE***	75
HA - HEAD TUBE ANGLE***	70
CS - CHAINSTAY LENGTH**	475
WB - WHEELBASE**	1168
REACH**	438
STACK**	626
BB DROP**	60

* dimension in inches, ** dimension in mm, *** dimension in degrees

TRANS HYBRID 2.0



FRAME

FRAME	ALUMINIUM
FORK	SR SUNTOUR NEX E25
FORK TRAVEL	63 mm
SIZES	DM(17"), DL(19")

DRIVETRAIN

REAR DERAILLEUR	SHIMANO ALIVIO M3100
FRONT BRAKE	POWER BH-M960
REAR BRAKE	POWER BH-M960
BRAKE LEVERS	POWER BH-M960
BRAKE DISCS	SHIMANO ALIVIO M3100
SHIFTERS	SHIMANO ALIVIO M3100
CRANKSET	BAFANG
SPROCKETS	38T/170 mm
CHAIN	SHIMANO E6070
CASSETTE/FREEWHEEL	SHIMANO ALTUS HG201
CASSETTE/FREEWHEEL RANGE	11-36T

WHEELS

FRONT HUB	GL-B43F-DS
REAR HUB	GL-B43R-DS
RIMS	KROSS
TIRES	WANDA G5001 28 x 1,75

COMPONENTS

HANDLEBAR	ALUMINIUM 640 mm 31.8
HANDLEBAR STEM	ALUMINIUM 90 mm/31.8 REG
SEAT POST	ALUMINIUM 27,2 x 300 mm
HEADSET	ALUMINIUM
SADDLE	YIBOTONG YBT-K607
GRIPS	HERRMANS
PEDALS	FP-210ZU
CARRIER	STANDWELL ALUMINIUM 28" 25 kg
FRONT LIGHT	HERRMANS H-IKE BATTERY
REAR LIGHT	BUHEL TIVOLI BATTERY
MUDGUARDS	TUBUS
KICK STAND	URSUS
BATTERY	PATHFINDER BATTERY 730WH
ENGINE	BAFANG G330.250
DISPLAY	DISPLAY DP C11 CAN

GEOMETRY

SIZE	DM	DL
FS - FRAME SIZE*	17	19
ST - SEAT TUBE LENGTH**	440	490
TT - TOP TUBE LENGTH**	605	605
HT - HEAD TUBE LENGTH**	140	140
SA - SEAT TUBE ANGLE***	75	75
HA - HEAD TUBE ANGLE***	70	70
CS - CHAINSTAY LENGTH**	475	475
WB - WHEELBASE**	1168	1168
REACH**	438	438
STACK**	626	626
BB DROP**	60	60

* dimension in inches, ** dimension in mm, *** dimension in degrees

GEAR RATIO 1 x 9

WHEEL DIAMETER 28"

COLOUR VARIANTS



SKU	SIZE	COLOUR	FINISH
KRTH2Z28X17W004474	DM	turquoise-gray	gloss
KRTH2Z28X19W004475	DL	turquoise-gray	gloss

TRANS HYBRID



SKU	SIZE	COLOUR	FINISH
KRTHZZ28X17M004254	S	brown-gray	mat
KRTHZZ28X19M004255	M	brown-gray	mat
KRTHZZ28X21M004256	L	brown-gray	mat

GEAR RATIO 3 x 8

WHEEL DIAMETER 28"

COLOUR VARIANTS



FRAME

FRAME	ALUMINIUM PERFORMANCE
FORK	SR SUNTOUR NEX HLO
FORK TRAVEL	63 mm
SIZES	S(17"), M(19"), L(21")

DRIVETRAIN

FRONT DERAILLEUR	SHIMANO TOURNEY TY710
REAR DERAILLEUR	SHIMANO DEORE M592
FRONT BRAKE	SHIMANO ALTUS ST-EF505
REAR BRAKE	SHIMANO MT200
BRAKE LEVERS	SHIMANO ALTUS ST-EF505
BRAKE DISCS	DISC (160 mm)
SHIFTERS	SHIMANO EF505
CRANKSET	ALUMINIUM
SPROCKETS	48T-38T-28T/170 mm
BOTTOM BRACKET	BAFANG
CHAIN	KMC HV700
CASSETTE/FREEWHEEL	SHIMANO ALTUS HG31
CASSETTE/FREEWHEEL RANGE	11-32T

WHEELS

FRONT HUB	GL-B43F-DS
REAR HUB	BAFANG G120.250.DC
RIMS	KROSS
TIRES	WANDA G5001 28 x 1,75

COMPONENTS

HANDLEBAR	STEEL 610 mm 25.4
HANDLEBAR STEM	ALUMINIUM 90/25,4 REG
SEAT POST	AMORTIZED 27,2 x 350 mm
HEADSET	FP-H805A; 1 1/8"
SADDLE	YIBOTONG YBT-K607
GRIPS	KROSS GRIPEN
PEDALS	FP-910
CARRIER	BUCHEL ALUMINIUM 28" 15 kg
FRONT LIGHT	HERRMANS H-IKE BATTERY
REAR LIGHT	BUCHEL TIVOLI BATTERY
MUDGUARDS	TUBUS
KICK STAND	URSUS
BATTERY	PHYLION SF-06S
ENGINE	BAFANG G120.250.DC
DISPLAY	BAFANG HMI DP E12.UART

GEOMETRY

SIZE	S	M	L
FS - FRAME SIZE*	17	19	21
ST - SEAT TUBE LENGTH**	430	480	530
TT - TOP TUBE LENGTH**	560	570	585
HT - HEAD TUBE LENGTH**	140	140	140
SA - SEAT TUBE ANGLE***	74	74	74
HA - HEAD TUBE ANGLE***	70	70	70
CS - CHAINSTAY LENGTH**	460	460	460
WB - WHEELBASE**	1084	1094	1109
REACH**	385	395	410
STACK**	610	610	610
BB DROP**	60	60	60

* dimension in inches, ** dimension in mm, *** dimension in degrees

TRANS HYBRID



GEAR RATIO 3 x 8
WHEEL DIAMETER 28"
COLOUR VARIANTS



SKU	SIZE	COLOUR	FINISH
KRTHZZ28X17W004252	DM	graphite-silver	mat
KRTHZZ28X19W004253	DL	graphite-silver	mat

FRAME

FRAME	ALUMINIUM PERFORMANCE
FORK	SR SUNTOUR NEX HLO
FORK TRAVEL	63 mm
SIZES	DM(17"), DL(19")

DRIVETRAIN

FRONT DERAILLEUR	SHIMANO TOURNEY TY710
REAR DERAILLEUR	SHIMANO DEORE M592
FRONT BRAKE	SHIMANO ALTUS ST-EF505
REAR BRAKE	SHIMANO MT200
BRAKE LEVERS	SHIMANO ALTUS ST-EF505
BRAKE DISCS	DISC (160 mm)
SHIFTERS	SHIMANO EF505
CRANKSET	ALUMINIUM
SPROCKETS	48T-38T-28T/170 mm
BOTTOM BRACKET	BAFANG
CHAIN	KMC HV700
CASSETTE/FREEWHEEL	SHIMANO ALTUS HG31
CASSETTE/FREEWHEEL RANGE	11-32T

WHEELS

FRONT HUB	GL-B43F-DS
REAR HUB	BAFANG G120.250.DC
RIMS	KROSS
TIRES	WANDA G5001 28 x 1,75

COMPONENTS

HANDLEBAR	STEEL 610 mm 25.4
HANDLEBAR STEM	ALUMINIUM 90/25,4 REG
SEAT POST	AMORTIZED 27,2 x 350 mm
HEADSET	FP-H805A; 1 1/8"
SADDLE	YIBOTONG YBT-K607
GRIPS	KROSS GRIPEN
PEDALS	FP-910
CARRIER	BUCHEL ALUMINIUM 28" 15 kg
FRONT LIGHT	HERRMANS H-IKE BATTERY
REAR LIGHT	BUCHEL TIVOLI BATTERY
MUDGUARDS	TUBUS
KICK STAND	URSUS
BATTERY	PHYLION SF-06S
ENGINE	BAFANG G120.250.DC
DISPLAY	BAFANG HMI DP E12.UART

GEOMETRY

SIZE	DM	DL
FS - FRAME SIZE*	17	19
ST - SEAT TUBE LENGTH**	430	480
TT - TOP TUBE LENGTH**	560	570
HT - HEAD TUBE LENGTH**	140	140
SA - SEAT TUBE ANGLE***	74	74
HA - HEAD TUBE ANGLE***	70	70
CS - CHAINSTAY LENGTH**	460	460
WB - WHEELBASE**	1084	1094
REACH**	385	395
STACK**	610	610
BB DROP**	60	60

* dimension in inches, ** dimension in mm, *** dimension in degrees



E-CROSS BIKES

EVADO HYBRID

A versatile electric bike designed for everyday recreational riding in the city and short trips outside the city.

Comfortable and secure: optimised for comfort and control at higher speeds.

Lightweight: equipped with just what you need to tackle the miles of trails efficiently.





EVADO HYBRID 6.0



SKU	SIZE	COLOUR	FINISH
KREH6Z28X17M004827	S	black-gray	gloss
KREH6Z28X19M004828	M	black-gray	gloss
KREH6Z28X21M004829	L	black-gray	gloss
KREH6Z28X23M004830	XL	black-gray	gloss

GEAR RATIO 1 x 10

WHEEL DIAMETER 28"

COLOUR VARIANTS



FRAME

FRAME	ALUMINIUM
FORK	ROCK SHOX PARAGON GOLD
FORK TRAVEL	65 mm
SIZES	S(17"), M(19"), L(21"), XL(23")

DRIVETRAIN

REAR DERAILLEUR	SHIMANO DEORE XT T8000
FRONT BRAKE	SHIMANO MT410
REAR BRAKE	SHIMANO MT410
BRAKE LEVERS	SHIMANO T402
BRAKE DISCS	SHIMANO RT30 (180)
SHIFTERS	SHIMANO DEORE M6000
CRANKSET	SHIMANO FC-E6100
SPROCKETS	38T/170 mm
CHAIN	SHIMANO E6090
CASSETTE/FREEWHEEL	SHIMANO GRX RX400 HG500
CASSETTE/FREEWHEEL RANGE	11-32T

WHEELS

FRONT HUB	SHIMANO ACERA M3050
REAR HUB	SHIMANO ACERA M3050
RIMS	KROSS ALUMINIUM 622 x 19
TIRES	SCHWALBE MARATHON 28 x 1,75

COMPONENTS

HANDLEBAR	ALUMINIUM 640 mm 31.8
HANDLEBAR STEM	ALUMINIUM 90 mm/31.8/7°
SEAT POST	ALUMINIUM 27.2 x 300 mm
HEADSET	FP-H856B2;1-1/8"-1.5"
SADDLE	SELLE ROYAL SHADOW
GRIPS	HERRMANS ADRENALIN
PEDALS	FP-210ZU
BATTERY	SIMPLO 630 WH
ENGINE	SHIMANO E6110
DISPLAY	SHIMANO SC-E6100C

GEOMETRY

SIZE	S	M	L	XL
FS - FRAME SIZE*	17	19	21	23
ST - SEAT TUBE LENGTH**	430	480	530	580
TT - TOP TUBE LENGTH**	575	585	605	630
HT - HEAD TUBE LENGTH**	140	140	140	160
SA - SEAT TUBE ANGLE***	74	74	74	74
HA - HEAD TUBE ANGLE***	69	70	70	70
CS - CHAINSTAY LENGTH**	450	450	450	450
WB - WHEELBASE**	1112	1111	1131	1157
REACH**	397	405	425	445
STACK**	622	627	627	646
BB DROP**	60	60	60	60

* dimension in inches, ** dimension in mm, *** dimension in degrees

EVADO HYBRID 6.0



SKU	SIZE	COLOUR	FINISH
KREH6Z28X19M004828	DM	blue-gray	gloss
KREH6Z28X19W004826	DL	blue-gray	gloss

GEAR RATIO 1 x 10

WHEEL DIAMETER 28"

COLOUR VARIANTS



FRAME

FRAME	ALUMINIUM
FORK	ROCK SHOX PARAGON GOLD
FORK TRAVEL	65 mm
SIZES	DM(17"), DL(19")

DRIVETRAIN

REAR DERAILLEUR	SHIMANO DEORE XT T8000
FRONT BRAKE	SHIMANO MT410
REAR BRAKE	SHIMANO MT410
BRAKE LEVERS	SHIMANO T402
BRAKE DISCS	SHIMANO RT30 (180)
SHIFTERS	SHIMANO DEORE M6000
CRANKSET	SHIMANO FC-E6100
SPROCKETS	38T/170 mm
CHAIN	SHIMANO E6090
CASSETTE/FREEWHEEL	SHIMANO GRX RX400 HG500
CASSETTE/FREEWHEEL RANGE	11-32T

WHEELS

FRONT HUB	SHIMANO ACERA M3050
REAR HUB	SHIMANO ACERA M3050
RIMS	KROSS ALUMINIUM 622 x 19
TIRES	SCHWALBE MARATHON 28 x 1,75

COMPONENTS

HANDLEBAR	ALUMINIUM 640 mm 31.8
HANDLEBAR STEM	ALUMINIUM 90 mm/31.8/7°
SEAT POST	ALUMINIUM 27.2 x 300 mm
HEADSET	FP-H856B2;1-1/8"-1.5"
SADDLE	SELLE ROYAL SHADOW
GRIPS	HERRMANS ADRENALIN
PEDALS	FP-210ZU
BATTERY	SIMPLO 630 WH
ENGINE	SHIMANO E6110
DISPLAY	SHIMANO SC-E6100C

GEOMETRY

SIZE	DM	DL
FS - FRAME SIZE*	17	19
ST - SEAT TUBE LENGTH**	430	480
TT - TOP TUBE LENGTH**	575	585
HT - HEAD TUBE LENGTH**	140	140
SA - SEAT TUBE ANGLE***	74	74
HA - HEAD TUBE ANGLE***	69	70
CS - CHAINSTAY LENGTH**	454	450
WB - WHEELBASE**	1112	1111
REACH**	397	405
STACK**	622	627
BB DROP**	60	60

* dimension in inches, ** dimension in mm, *** dimension in degrees

EVADO HYBRID 3.0



GEAR RATIO 1 x 9

WHEEL DIAMETER 28"

COLOUR VARIANTS



SKU	SIZE	COLOUR	FINISH
KREH3Z28X18M004955	M	black-beige	gloss
KREH3Z28X21M004788	L	black-beige	gloss

FRAME

FRAME	ALUMINIUM
FORK	SR SUNTOUR NEX E25
FORK TRAVEL	63 mm
SIZES	M(18"), L(21")

DRIVETRAIN

REAR DERAILLEUR	SHIMANO DEORE M592
FRONT BRAKE	POWER BH-M960
REAR BRAKE	POWER BH-M960
BRAKE LEVERS	POWER BH-M960
BRAKE DISCS	SHIMANO DEORE M592
SHIFTERS	SHIMANO DEORE M592
CRANKSET	BAFANG
SPROCKETS	38T/170 mm
CHAIN	SHIMANO E6070
CASSETTE/FREEWHEEL	SHIMANO ALTUS HG201
CASSETTE/FREEWHEEL RANGE	11-36T

WHEELS

FRONT HUB	GL-B43F-DS
REAR HUB	GL-B43R-DS
RIMS	KROSS ALUMINIUM 622 x 19
TIRES	WANDA G5001 28 x 1,75

COMPONENTS

HANDLEBAR	ALUMINIUM 640 mm 31.8
HANDLEBAR STEM	ALUMINIUM 75 mm/31,8/7°
SEAT POST	ALUMINIUM 27,2 x 350 mm
HEADSET	ALUMINIUM
SADDLE	SELLE ROYAL SHADOW
GRIPS	HERRMANS
PEDALS	FP-210ZU
BATTERY	PATHFINDER BATTERY 882WH
ENGINE	BAFANG G330.250
DISPLAY	DISPLAY DP C11 CAN

GEOMETRY

SIZE	M	L
FS - FRAME SIZE*	18	21
ST - SEAT TUBE LENGTH**	460	530
TT - TOP TUBE LENGTH**	605	605
HT - HEAD TUBE LENGTH**	140	140
SA - SEAT TUBE ANGLE***	75	75
HA - HEAD TUBE ANGLE***	70	70
CS - CHAINSTAY LENGTH**	475	475
WB - WHEELBASE**	1168	1168
REACH**	438	438
STACK**	626	626
BB DROP**	60	60

* dimension in inches, ** dimension in mm, *** dimension in degrees

EVADO HYBRID 3.0



GEAR RATIO 1 x 9

WHEEL DIAMETER 28"

COLOUR VARIANTS



SKU	SIZE	COLOUR	FINISH
KREH3Z28X17W004784	DM	pearly-silver	gloss
KREH3Z28X19W004785	DL	pearly-silver	gloss

FRAME

FRAME	ALUMINIUM
FORK	SR SUNTOUR NEX E25
FORK TRAVEL	63 mm
SIZES	DM(17"), DL(19")

DRIVETRAIN

REAR DERAILLEUR	SHIMANO DEORE M592
FRONT BRAKE	POWER BH-M960
REAR BRAKE	POWER BH-M960
BRAKE LEVERS	POWER BH-M960
BRAKE DISCS	SHIMANO DEORE M592
SHIFTERS	SHIMANO DEORE M592
CRANKSET	BAFANG
SPROCKETS	38T/170 mm
CHAIN	SHIMANO E6070
CASSETTE/FREEWHEEL	SHIMANO ALTUS HG201
CASSETTE/FREEWHEEL RANGE	11-36T

WHEELS

FRONT HUB	GL-B43F-DS
REAR HUB	GL-B43R-DS
RIMS	KROSS ALUMINIUM 622 x 19
TIRES	WANDA G5001 28 x 1,75

COMPONENTS

HANDLEBAR	ALUMINIUM 640 mm 31.8
HANDLEBAR STEM	ALUMINIUM 75 mm/31,8/7°
SEAT POST	ALUMINIUM 27,2 x 350 mm
HEADSET	ALUMINIUM
SADDLE	SELLE ROYAL SHADOW
GRIPS	HERRMANS
PEDALS	FP-210ZU
BATTERY	PATHFINDER BATTERY 882WH
ENGINE	BAFANG G330.250
DISPLAY	DISPLAY DP C11 CAN

GEOMETRY

SIZE	DM	DL
FS - FRAME SIZE*	17	19
ST - SEAT TUBE LENGTH**	440	490
TT - TOP TUBE LENGTH**	605	605
HT - HEAD TUBE LENGTH**	140	140
SA - SEAT TUBE ANGLE***	75	75
HA - HEAD TUBE ANGLE***	70	70
CS - CHAINSTAY LENGTH**	475	475
WB - WHEELBASE**	1168	1168
REACH**	438	438
STACK**	626	626
BB DROP**	60	60

* dimension in inches, ** dimension in mm, *** dimension in degrees

EVADO HYBRID 2.0



GEAR RATIO 1 x 9

WHEEL DIAMETER 28"

COLOUR VARIANTS



SKU	SIZE	COLOUR	FINISH
KREH2Z28X18M004954	M	ruby-silver	gloss
KREH2Z28X21M004783	L	ruby-silver	gloss

FRAME

FRAME	ALUMINIUM
FORK	SR SUNTOUR NEX E25
FORK TRAVEL	63 mm
SIZES	M(19"), L(21")

DRIVETRAIN

REAR DERAILLEUR	SHIMANO ALIVIO M3100
FRONT BRAKE	POWER BH-M960
REAR BRAKE	POWER BH-M960
BRAKE LEVERS	POWER BH-M960
BRAKE DISCS	DISC (160 mm)
SHIFTERS	SHIMANO ALIVIO M3100
CRANKSET	BAFANG
SPROCKETS	38T/170 mm
CHAIN	SHIMANO E6070
CASSETTE/FREEWHEEL	SHIMANO ALTUS HG201
CASSETTE/FREEWHEEL RANGE	11-34T

WHEELS

FRONT HUB	GL-B43F-DS
REAR HUB	GL-B43R-DS
RIMS	KROSS ALUMINIUM 622 x 19
TIRES	WANDA G5001 28 x 1,75

COMPONENTS

HANDLEBAR	ALUMINIUM 640 mm 31.8
HANDLEBAR STEM	ALUMINIUM 75 mm/31,8/7°
SEAT POST	ALUMINIUM 27,2 x 350 mm
HEADSET	ALUMINIUM
SADDLE	SELLE ROYAL SHADOW
GRIPS	HERRMANS
PEDALS	FP-210ZU
BATTERY	PATHFINDER BATTERY 730WH
ENGINE	BAFANG G330.250
DISPLAY	DISPLAY DP C11 CAN

GEOMETRY

SIZE	M	L
FS - FRAME SIZE*	18	21
ST - SEAT TUBE LENGTH**	460	530
TT - TOP TUBE LENGTH**	605	605
HT - HEAD TUBE LENGTH**	140	140
SA - SEAT TUBE ANGLE***	75	75
HA - HEAD TUBE ANGLE***	70	70
CS - CHAINSTAY LENGTH**	475	475
WB - WHEELBASE**	1168	1168
REACH**	438	438
STACK**	626	626
BB DROP**	60	60

* dimension in inches, ** dimension in mm, *** dimension in degrees

EVADO HYBRID 2.0



GEAR RATIO 1 x 9

WHEEL DIAMETER 28"

COLOUR VARIANTS



SKU	SIZE	COLOUR	FINISH
KREH2Z28X17W004779	DM	gray-black	gloss
KREH2Z28X19W004780	DL	gray-black	gloss

FRAME

FRAME	ALUMINIUM
FORK	SR SUNTOUR NEX E25
FORK TRAVEL	63 mm
SIZES	DM(17"), DL(19")

DRIVETRAIN

REAR DERAILLEUR	SHIMANO ALIVIO M3100
FRONT BRAKE	POWER BH-M960
REAR BRAKE	POWER BH-M960
BRAKE LEVERS	POWER BH-M960
BRAKE DISCS	DISC (160 mm)
SHIFTERS	SHIMANO ALIVIO M3100
CRANKSET	BAFANG
SPROCKETS	38T/170 mm
CHAIN	SHIMANO E6070
CASSETTE/FREEWHEEL	SHIMANO ALTUS HG201
CASSETTE/FREEWHEEL RANGE	11-34T

WHEELS

FRONT HUB	GL-B43F-DS
REAR HUB	GL-B43R-DS
RIMS	KROSS ALUMINIUM 622 x 19
TIRES	WANDA G5001 28 x 1,75

COMPONENTS

HANDLEBAR	ALUMINIUM 640 mm 31.8
HANDLEBAR STEM	ALUMINIUM 75 mm/31,8/7°
SEAT POST	ALUMINIUM 27,2 x 350 mm
HEADSET	ALUMINIUM
SADDLE	SELLE ROYAL SHADOW
GRIPS	HERRMANS
PEDALS	FP-210ZU
BATTERY	PATHFINDER BATTERY 730WH
ENGINE	BAFANG G330.250
DISPLAY	DISPLAY DP C11 CAN

GEOMETRY

SIZE	DM	DL
FS - FRAME SIZE*	17	19
ST - SEAT TUBE LENGTH**	440	490
TT - TOP TUBE LENGTH**	605	605
HT - HEAD TUBE LENGTH**	140	140
SA - SEAT TUBE ANGLE***	75	75
HA - HEAD TUBE ANGLE***	70	70
CS - CHAINSTAY LENGTH**	475	475
WB - WHEELBASE**	1168	1168
REACH**	438	438
STACK**	626	626
BB DROP**	60	60

* dimension in inches, ** dimension in mm, *** dimension in degrees

EVADO HYBRID 1.0



SKU	SIZE	COLOUR	FINISH
KREH1Z28X17M004241	S	black-gray	mat
KREH1Z28X19M004242	M	black-gray	mat
KREH1Z28X21M004243	L	black-gray	mat
KREH1Z28X23M004244	XL	black-gray	mat

GEAR RATIO 3 x 9

WHEEL DIAMETER 28"

COLOUR VARIANTS



FRAME

FRAME	ALUMINIUM
FORK	SR SUNTOUR NEX HLO
FORK TRAVEL	63 mm
SIZES	S(17"), M(19"), L(21"), XL(23")

DRIVETRAIN

FRONT DERAILLEUR	SHIMANO ALTUS M370
REAR DERAILLEUR	SHIMANO ACERA T3000
FRONT BRAKE	POWER BH-M960
REAR BRAKE	POWER BH-M960
BRAKE LEVERS	POWER BH-M960
BRAKE DISCS	DISC (160 mm)
SHIFTERS	SHIMANO ALIVIO M3100
CRANKSET	SHIMANO ACERA T3010
SPROCKETS	48T-36T-26T/170 mm
BOTTOM BRACKET	BAFANG
CHAIN	SHIMANO HG53
CASSETTE/FREEWHEEL	SHIMANO ALTUS HG200
CASSETTE/FREEWHEEL RANGE	11-32T

WHEELS

FRONT HUB	GL-B43F-DS
REAR HUB	BAFANG G120.250.DC
RIMS	KROSS ALUMINIUM 622 x 19
TIRES	WANDA G5001 28 x 1,75

COMPONENTS

HANDLEBAR	ALUMINIUM 620 mm 31.8
HANDLEBAR STEM	ALUMINIUM 90 mm/31,8/7°
SEAT POST	ALUMINIUM 27,2 x 300 mm
HEADSET	FP-H816 O1-1/8"
SADDLE	SELLE ROYAL SHADOW
GRIPS	HERRMANS OXY
PEDALS	FP-971
BATTERY	PHYLION SF-06S
ENGINE	BAFANG G120.250.DC
DISPLAY	BAFANG HMI DP E12.UART

GEOMETRY

SIZE	S	M	L	XL
FS - FRAME SIZE*	17	19	21	23
ST - SEAT TUBE LENGTH**	430	470	520	570
TT - TOP TUBE LENGTH**	572	582	597	612
HT - HEAD TUBE LENGTH**	140	150	150	160
SA - SEAT TUBE ANGLE***	73	73	73	73
HA - HEAD TUBE ANGLE***	70	70	70	70
CS - CHAINSTAY LENGTH**	445	445	445	445
WB - WHEELBASE**	1074	1084	1099	1114
REACH**	385	395	410	422
STACK**	610	610	610	619
BB DROP**	50	50	50	50

* dimension in inches, ** dimension in mm, *** dimension in degrees

EVADO HYBRID 1.0



FRAME

FRAME	ALUMINIUM
FORK	SR SUNTOUR NEX HLO
FORK TRAVEL	63 mm
SIZES	DM(17"), DL(19")

DRIVETRAIN

FRONT DERAILLEUR	SHIMANO ALTUS M370
REAR DERAILLEUR	SHIMANO ACERA T3000
FRONT BRAKE	POWER BH-M960
REAR BRAKE	POWER BH-M960
BRAKE LEVERS	POWER BH-M960
BRAKE DISCS	DISC (160 mm)
SHIFTERS	SHIMANO ALIVIO M3100
CRANKSET	SHIMANO ACERA T3010
SPROCKETS	48T-36T-26T/170 mm
BOTTOM BRACKET	BAFANG
CHAIN	SHIMANO HG53
CASSETTE/FREEWHEEL	SHIMANO ALTUS HG200
CASSETTE/FREEWHEEL RANGE	11-32T

WHEELS

FRONT HUB	GL-B43F-DS
REAR HUB	BAFANG G120.250.DC
RIMS	KROSS ALUMINIUM 622 x 19
TIRES	WANDA G5001 28 x 1,75

COMPONENTS

HANDLEBAR	ALUMINIUM 620 mm 31.8
HANDLEBAR STEM	ALUMINIUM 90 mm/31,8/7°
SEAT POST	ALUMINIUM 27,2 x 300 mm
HEADSET	FP-H816 O1-1/8"
SADDLE	SELLE ROYAL SHADOW
GRIPS	HERRMANS OXY
PEDALS	FP-971
BATTERY	PHYLION SF-06S
ENGINE	BAFANG G120.250.DC
DISPLAY	BAFANG HMI DP E12.UART

GEOMETRY

SIZE	DM	DL
FS - FRAME SIZE*	17	19
ST - SEAT TUBE LENGTH**	430	470
TT - TOP TUBE LENGTH**	560	582
HT - HEAD TUBE LENGTH**	140	150
SA - SEAT TUBE ANGLE***	73	73
HA - HEAD TUBE ANGLE***	70	70
CS - CHAINSTAY LENGTH**	445	445
WB - WHEELBASE**	1062	1084
REACH**	374	395
STACK**	610	610
BB DROP**	50	50

* dimension in inches, ** dimension in mm, *** dimension in degrees

SKU	SIZE	COLOUR	FINISH
KREH1Z28X17W004239	DM	white-turquoise	gloss
KREH1Z28X19W004240	DL	white-turquoise	gloss

GEAR RATIO 3 x 9

WHEEL DIAMETER 28"

COLOUR VARIANTS



E-CITY BIKES

SENTIO HYBRID, ELILLE, INZAI HYBRID

Sentio Hybrid, eLille and Inzai Hybrid are series of city-type electric bikes, designed for comfortable and stylish urban transportation, for recreational outings and shopping.

Top-tier components: Shimano motor with autoshift Di2.

Low frame: ease of mounting and dismounting.





SENTIO HYBRID 7.0



GEAR RATIO 1 x 8

WHEEL DIAMETER 28"

COLOUR VARIANTS



SKU	SIZE	COLOUR	FINISH
KRSH7Z28X22M006557	L	black-blue	gloss
KRSH7Z28X24M006558	XL	black-blue	gloss

FRAME

FRAME	ALUMINIUM PERFORMANCE
FORK	SR SUNTOUR MOBIE32 COIL
FORK TRAVEL	63 mm
SIZES	L(57"), XL(61")

DRIVETRAIN

REAR DERAILLEUR	SHIMANO ALFINE
FRONT BRAKE	SHIMANO ALFINE-S7000
REAR BRAKE	SHIMANO ALFINE-S7000
BRAKE LEVERS	SHIMANO ALFINE-S7000
BRAKE DISCS	SHIMANO SM-RT54-S
SHIFTERS	SHIMANO
CRANKSET	GATES CDX
SPROCKETS	50T
CHAIN	GATES CDX
CASSETTE/FREEWHEEL	GATES CDXR
CASSETTE/FREEWHEEL RANGE	28T

WHEELS

FRONT HUB	SHIMANO HB-M6010
REAR HUB	SHIMANO ALFINE 8 DI2
RIMS	RYDE ANDRA 321 622 x 21
TIRES	VREDESTEIN PERFECT 28 x 1,75

COMPONENTS

HANDLEBAR	Satori Wien (Di2 version)
HANDLEBAR STEM	SATORI UP3E 110/31,8 REG
SEAT POST	AMORTIZED 31,6 x 350 mm
HEADSET	FSA ORBIT C-40-ACB TAPERED
SADDLE	SELLE ROYAL NEW LOOKIN MOD M
GRIPS	VELO -Leather Black
PEDALS	FP-210
CARRIER	ATRAN VELO ALUMINIUM
FRONT LIGHT	B&M IQ-XS DYNAMO/EBIKE
REAR LIGHT	SPANNINGA PIMENTO DYNAMO/EBIKE
MUDGUARDS	PLETSCHER
KICK STAND	ATRAN VELO
BATTERY	SIMPLO INTEGRATED 500 WH
ENGINE	SHIMANO FC-E6100
DISPLAY	SHIMANO SC-E6100

GEOMETRY

SIZE	L	XL
FS - FRAME SIZE*	57	61
ST - SEAT TUBE LENGTH**	570	610
TT - TOP TUBE LENGTH**	602	608
HT - HEAD TUBE LENGTH**	170	190
SA - SEAT TUBE ANGLE***	72	72
HA - HEAD TUBE ANGLE***	72	72
CS - CHAINSTAY LENGTH**	470	470
WB - WHEELBASE**	1095	1101
REACH**	391	391
STACK**	650	669
BB DROP**	65	65

* dimension in inches, ** dimension in mm, *** dimension in degrees

SENTIO HYBRID 7.0



SKU	SIZE	COLOUR	FINISH
KRSH7Z28X19W006550	DS	black-blue	gloss
KRSH7Z28X20W006551	DM	black-blue	gloss
KRSH7Z28X22W006552	DL	black-blue	gloss

GEAR RATIO 1 x 8

WHEEL DIAMETER 28"

COLOUR VARIANTS



FRAME

FRAME	ALUMINIUM PERFORMANCE
FORK	SR SUNTOUR MOBIE32 COIL
FORK TRAVEL	63 mm
SIZES	DS(19"), DM(20"), DL(22")

DRIVETRAIN

REAR DERAILLEUR	SHIMANO ALFINE
FRONT BRAKE	SHIMANO ALFINE-S7000
REAR BRAKE	SHIMANO ALFINE-S7000
BRAKE LEVERS	SHIMANO ALFINE-S7000
BRAKE DISCS	SHIMANO SM-RT54-S
SHIFTERS	SHIMANO
CRANKSET	GATES CDX
SPROCKETS	50T
CHAIN	GATES CDX
CASSETTE/FREEWHEEL	GATES CDXR
CASSETTE/FREEWHEEL RANGE	28T

WHEELS

FRONT HUB	SHIMANO HB-M6010
REAR HUB	SHIMANO ALFINE 8 DI2
RIMS	RYDE ANDRA 321 622 x 21
TIRES	VREDESTEIN PERFECT 28 x 1,75

COMPONENTS

HANDLEBAR	Satori Wien (Di2 version)
HANDLEBAR STEM	SATORI UP3E 110/31,8 REG
SEAT POST	AMORTIZED 31,6 x 350 mm
HEADSET	FSA ORBIT C-40-ACB TAPERED
SADDLE	SELLE ROYAL NEW LOOKIN MOD W
GRIPS	VELO -Leather Black
PEDALS	FP-210
CARRIER	ATRAN VELO ALUMINIUM
FRONT LIGHT	B&M IQ-XS DYNAMO/EBIKE
REAR LIGHT	SPANNINGA PIMENTO DYNAMO/EBIKE
MUDGUARDS	PLETSCHER
KICK STAND	ATRAN VELO
BATTERY	SIMPLO INTEGRATED 500 WH
ENGINE	SHIMANO FC-E6100
DISPLAY	SHIMANO SC-E6100

GEOMETRY

SIZE	DS	DM	DL
FS - FRAME SIZE*	19	20	22
ST - SEAT TUBE LENGTH**	490	530	570
TT - TOP TUBE LENGTH**	592	596	606
HT - HEAD TUBE LENGTH**	160	170	190
SA - SEAT TUBE ANGLE***	72	72	72
HA - HEAD TUBE ANGLE***	72	72	72
CS - CHAINSTAY LENGTH**	470	470	470
WB - WHEELBASE**	1089	1089	1099
REACH**	384	385	389
STACK**	640	650	669
BB DROP**	65	65	65

* dimension in inches, ** dimension in mm, *** dimension in degrees

SENTIO HYBRID 6.0



GEAR RATIO 1 x 8

WHEEL DIAMETER 28"

COLOUR VARIANTS



SKU	SIZE	COLOUR	FINISH
KRSH6Z28X22M006540	L	green-gray	mat
KRSH6Z28X24M006541	XL	green-gray	mat

FRAME

FRAME	ALUMINIUM PERFORMANCE
FORK	SR SUNTOUR MOBIE32 COIL
FORK TRAVEL	63 mm
SIZES	L(57"), XL(61")

DRIVETRAIN

REAR DERAILLEUR	SHIMANO NEXUS
FRONT BRAKE	SHIMANO MT200
REAR BRAKE	SHIMANO MT200
BRAKE LEVERS	SHIMANO MT201
BRAKE DISCS	SHIMANO RT10 160 CL
SHIFTERS	SHIMANO SW-E7000
CRANKSET	SHIMANO FC-E6100
SPROCKETS	38T
CHAIN	SHIMANO HG71
CASSETTE/FREEWHEEL	SHIMANO
CASSETTE/FREEWHEEL RANGE	19T

WHEELS

FRONT HUB	SHIMANO HB-MT400
REAR HUB	SG-C6061-8D NEXUS 8 D12
RIMS	RYDE DUTCH 19 622 x 19
TIRES	VREDESTEIN PERFECT 28 x 1,75

COMPONENTS

HANDLEBAR	Satori Wien (Di2 version)
HANDLEBAR STEM	SATORI UP3E 110/31,8 REG
SEAT POST	AMORTIZED 31,6 x 350 mm
HEADSET	FSA ORBIT C-40-ACB TAPERED
SADDLE	SELLE ROYAL ESSENZA MOD M
GRIPS	Velo VLG-1859 MICROTECH
PEDALS	FP-210
CARRIER	ATRAN VELO ALUMINIUM
FRONT LIGHT	B&M MYC DYNAMO/EBIKE
REAR LIGHT	SPANNINGA SOLO DYNAMO/EBIKE
MUDGUARDS	SKS EDGE
KICK STAND	ATRAN VELO
BATTERY	SIMPLO 504 WH
ENGINE	SHIMANO E6100
DISPLAY	SHIMANO SC-E6100

GEOMETRY

SIZE	L	XL
FS - FRAME SIZE*	57	61
ST - SEAT TUBE LENGTH**	570	610
TT - TOP TUBE LENGTH**	602	608
HT - HEAD TUBE LENGTH**	170	190
SA - SEAT TUBE ANGLE***	72	72
HA - HEAD TUBE ANGLE***	72	72
CS - CHAINSTAY LENGTH**	470	470
WB - WHEELBASE**	1095	1101
REACH**	391	391
STACK**	650	669
BB DROP**	65	65

* dimension in inches, ** dimension in mm, *** dimension in degrees

SENTIO HYBRID 6.0



SKU	SIZE	COLOUR	FINISH
KRSH6Z28X19W006534	DS	navy blue-black	gloss
KRSH6Z28X19W006537	DS	cherry-black	gloss
KRSH6Z28X20W006538	DM	cherry-black	gloss
KRSH6Z28X22W006539	DL	cherry-black	gloss

GEAR RATIO 1 x 8

WHEEL DIAMETER 28"

COLOUR VARIANTS



FRAME

FRAME	ALUMINIUM PERFORMANCE
FORK	SR SUNTOUR MOBIE32 COIL
FORK TRAVEL	63 mm
SIZES	DS(19"), DM(20"), DL(22")

DRIVETRAIN

REAR DERAILLEUR	SHIMANO NEXUS
FRONT BRAKE	SHIMANO MT200
REAR BRAKE	SHIMANO MT200
BRAKE LEVERS	SHIMANO MT201
BRAKE DISCS	SHIMANO RT10 160 CL
SHIFTERS	SHIMANO SW-E7000
CRANKSET	SHIMANO FC-E6100
SPROCKETS	38T
CHAIN	SHIMANO HG71
CASSETTE/FREEWHEEL	SHIMANO
CASSETTE/FREEWHEEL RANGE	19T

WHEELS

FRONT HUB	SHIMANO HB-MT400
REAR HUB	SG-C6061-8D NEXUS 8 D12
RIMS	RYDE DUTCH 19 622 x 19
TIRES	VREDESTEIN PERFECT 28 x 1,75

COMPONENTS

HANDLEBAR	Satori Wien (Di2 version)
HANDLEBAR STEM	SATORI UP3E 110/31,8 REG
SEAT POST	AMORTIZED 31,6 x 350 mm
HEADSET	FSA ORBIT C-40-ACB TAPERED
SADDLE	SELLE ROYAL ESSENZA MOD W
GRIPS	Velo VLG-1859 MICROTECH
PEDALS	FP-210
CARRIER	ATRAN VELO ALUMINIUM
FRONT LIGHT	B&M MYC DYNAMO/EBIKE
REAR LIGHT	SPANNINGA SOLO DYNAMO/EBIKE
MUDGUARDS	SKS EDGE
KICK STAND	ATRAN VELO
BATTERY	SIMPLO 504 WH
ENGINE	SHIMANO E6100
DISPLAY	SHIMANO SC-E6100

GEOMETRY

SIZE	DS	DM	DL
FS - FRAME SIZE*	19	20	22
ST - SEAT TUBE LENGTH**	490	530	570
TT - TOP TUBE LENGTH**	592	596	606
HT - HEAD TUBE LENGTH**	160	170	190
SA - SEAT TUBE ANGLE***	72	72	72
HA - HEAD TUBE ANGLE***	72	72	72
CS - CHAINSTAY LENGTH**	470	470	470
WB - WHEELBASE**	1085	1089	1099
REACH**	384	385	389
STACK**	640	650	669
BB DROP**	65	65	65

* dimension in inches, ** dimension in mm, *** dimension in degrees

SENTIO HYBRID 5.0



SKU	SIZE	COLOUR	FINISH
KRSH5Z28X22M007134	XL	turquoise	gloss
KRSH5Z28X24M007135	XXL	turquoise	gloss
KRSH5Z28X22M007139	XL	black	gloss
KRSH5Z28X24M007140	XXL	black	gloss

GEAR RATIO 1 x 7

WHEEL DIAMETER 28"

COLOUR VARIANTS



FRAME

FRAME	ALUMINIUM PERFORMANCE
FORK	SR SUNTOUR NEX E25
FORK TRAVEL	50 mm
SIZES	XL(22"), XXL(24")

DRIVETRAIN

REAR DERAILLEUR	SHIMANO NEXUS
FRONT BRAKE	SHIMANO MT200
REAR BRAKE	SHIMANO MT200
BRAKE LEVERS	SHIMANO MT200
BRAKE DISCS	SHIMANO RT10 160 CL
SHIFTERS	SL-C3000-7
CRANKSET	FC-E5010
SPROCKETS	46T
CHAIN	GATES CDX
CASSETTE/FREEWHEEL	VEER
CASSETTE/FREEWHEEL RANGE	22T

WHEELS

FRONT HUB	HB-M4050
REAR HUB	SG-C3001-7D
RIMS	KROSS ALUMINIUM 622 x 19
TIRES	VREDESTEIN DYNAMIC 28 x 1,75

COMPONENTS

HANDLEBAR	ALUMINIUM 640 mm 31.8
HANDLEBAR STEM	ALUMINIUM 110 mm/31,8 REG
SEAT POST	AMORTIZED 31,6 x 350 mm
HEADSET	FSA C-40-ACB
SADDLE	SELLE ROYAL ESSENZA MOD M
GRIPS	VELO VLG-1670
PEDALS	FP-210
CARRIER	ATLAN VELO ALUMINIUM
FRONT LIGHT	SKS Edge
REAR LIGHT	SPANNINGA SOLO DYNAMO/EBIKE
MUDGUARDS	SKS EDGE
KICK STAND	ATLAN VELO
BATTERY	SHIMANO BT-E6001 504 WH
ENGINE	SHIMANO STEPS E5000
DISPLAY	SHIMANO SC-E6100

GEOMETRY

SIZE	XL	XXL
FS - FRAME SIZE*	22	24
ST - SEAT TUBE LENGTH**	570	610
TT - TOP TUBE LENGTH**	611	616
HT - HEAD TUBE LENGTH**	155	175
SA - SEAT TUBE ANGLE***	72	72
HA - HEAD TUBE ANGLE***	70	70
CS - CHAINSTAY LENGTH**	460	460
WB - WHEELBASE**	1116	1122
REACH**	407	406
STACK**	627	646
BB DROP**	65	65

* dimension in inches, ** dimension in mm, *** dimension in degrees

SENTIO HYBRID 5.0



SKU	SIZE	COLOUR	FINISH
KRSH5Z28X19W007131	DM	turquoise	gloss
KRSH5Z28X21W007132	DL	turquoise	gloss
KRSH5Z28X22W007133	DXL	turquoise	gloss
KRSH5Z28X19W007136	DM	black	gloss
KRSH5Z28X21W007137	DL	black	gloss
KRSH5Z28X22W007138	DXL	black	gloss

GEAR RATIO 1 x 7

WHEEL DIAMETER 28"

COLOUR VARIANTS



FRAME

FRAME	ALUMINIUM PERFORMANCE
FORK	SR SUNTOUR NEX E25
FORK TRAVEL	50 mm
SIZES	DM(19"), DL(21"), DXL(22")

DRIVETRAIN

REAR DERAILLEUR	SHIMANO NEXUS
FRONT BRAKE	SHIMANO MT200
REAR BRAKE	SHIMANO MT200
BRAKE LEVERS	SHIMANO MT200
BRAKE DISCS	SHIMANO RT10 160 CL
SHIFTERS	SL-C3000-7
CRANKSET	FC-E5010
SPROCKETS	46T
CHAIN	GATES CDX
CASSETTE/FREEWHEEL	VEER
CASSETTE/FREEWHEEL RANGE	22T

WHEELS

FRONT HUB	HB-M4050
REAR HUB	SG-C3001-7D
RIMS	KROSS ALUMINIUM 622 x 19
TIRES	VREDESTEIN DYNAMIC 28 x 1,75

COMPONENTS

HANDLEBAR	ALUMINIUM 640 mm 31.8
HANDLEBAR STEM	ALUMINIUM 110 mm/31,8 REG
SEAT POST	AMORTIZED 31,6 x 350 mm
HEADSET	FSA C-40-ACB
SADDLE	SELLE ROYAL ESSENZA MOD W
GRIPS	VELO VLG-1670
PEDALS	FP-210
CARRIER	ATLAN VELO ALUMINIUM
FRONT LIGHT	SKS Edge
REAR LIGHT	SPANNINGA SOLO DYNAMO/EBIKE
MUDGUARDS	SKS EDGE
KICK STAND	ATLAN VELO
BATTERY	SHIMANO BT-E6001 504 WH
ENGINE	SHIMANO STEPS E5000
DISPLAY	SHIMANO SC-E6100

GEOMETRY

SIZE	DM	DL	DXL
FS - FRAME SIZE*	19	21	22
ST - SEAT TUBE LENGTH**	490	530	570
TT - TOP TUBE LENGTH**	598	603	613
HT - HEAD TUBE LENGTH**	170	170	190
SA - SEAT TUBE ANGLE***	72	72	72
HA - HEAD TUBE ANGLE***	70	70	70
CS - CHAINSTAY LENGTH**	460	460	460
WB - WHEELBASE**	1104	1109	1119
REACH**	390	395	398
STACK**	641	641	660
BB DROP**	65	65	65

* dimension in inches, ** dimension in mm, *** dimension in degrees

SENTIO HYBRID 4.0



GEAR RATIO 1 x 7

WHEEL DIAMETER 28"

COLOUR VARIANTS



SKU	SIZE	COLOUR	FINISH
KRSH4Z28X22M007126	XL	green	gloss
KRSH4Z28X24M007127	XXL	green	gloss

FRAME

FRAME	ALUMINIUM PERFORMANCE
FORK	SR SUNTOUR NEX-E25
FORK TRAVEL	50 mm
SIZES	XL(22"), XXL(24")

DRIVETRAIN

REAR DERAILLEUR	SHIMANO NEXUS
FRONT BRAKE	SHIMANO MT200
REAR BRAKE	SHIMANO MT200
BRAKE LEVERS	SHIMANO MT200
BRAKE DISCS	SHIMANO RT10 160 CL
SHIFTERS	SL-C3000-7
CRANKSET	FC-E5010
SPROCKETS	38T
CHAIN	CN-HG71
CASSETTE/FREEWHEEL	SHIMANO
CASSETTE/FREEWHEEL RANGE	19T

WHEELS

FRONT HUB	HB-M4050
REAR HUB	SG-C3001-7D
RIMS	KROSS
TIRES	VREDESTEIN DYNAMIC 28 x 1,75

COMPONENTS

HANDLEBAR	NR-AL -124BTFOV
HANDLEBAR STEM	ALUMINIUM 110 mm/31,8 REG
SEAT POST	AMORTIZED 31,6 x 350 mm
HEADSET	FSA C-40-ACB
SADDLE	SELLE ROYAL ESSENZA MOD M
GRIPS	VELO VLG-1670
PEDALS	FP-210
CARRIER	ATLAN VELO ALUMINIUM
FRONT LIGHT	SKS Edge
REAR LIGHT	SPANNINGA SOLO DYNAMO/EBIKE
MUDGUARDS	SKS EDGE
KICK STAND	ATLAN VELO
BATTERY	SHIMANO BT-E6000, 418Wh
ENGINE	SHIMANO STEPS E5000
DISPLAY	SHIMANO SC-E6100

GEOMETRY

SIZE	XL	XXL
FS - FRAME SIZE*	22	24
ST - SEAT TUBE LENGTH**	570	610
TT - TOP TUBE LENGTH**	611	616
HT - HEAD TUBE LENGTH**	155	175
SA - SEAT TUBE ANGLE***	72	72
HA - HEAD TUBE ANGLE***	70	70
CS - CHAINSTAY LENGTH**	460	460
WB - WHEELBASE**	1116	1122
REACH**	407	406
STACK**	627	646
BB DROP**	65	65

* dimension in inches, ** dimension in mm, *** dimension in degrees

SENTIO HYBRID 4.0



SKU	SIZE	COLOUR	FINISH
KRSH4Z28X19W007118	DM	navy	gloss
KRSH4Z28X21W007119	DL	navy	gloss
KRSH4Z28X22W007120	DXL	navy	gloss
KRSH4Z28X19W007123	DM	green	gloss
KRSH4Z28X21W007124	DL	green	gloss
KRSH4Z28X22W007125	DXL	green	gloss

GEAR RATIO 1 x 7

WHEEL DIAMETER 28"

COLOUR VARIANTS



FRAME

FRAME	ALUMINIUM PERFORMANCE
FORK	SR SUNTOUR NEX-E25
FORK TRAVEL	50 mm
SIZES	DM(19"), DL(21"), DXL(22")

DRIVETRAIN

FRONT BRAKE	SHIMANO MT200
REAR BRAKE	SHIMANO MT200
BRAKE LEVERS	SHIMANO MT200
BRAKE DISCS	SHIMANO RT10 160 CL
SHIFTERS	SL-C3000-7
CRANKSET	FC-E5010
SPROCKETS	38T
CHAIN	CN-HG71

WHEELS

FRONT HUB	HB-M4050
REAR HUB	SG-C3001-7D
RIMS	KROSS
TIRES	VREDESTEIN DYNAMIC 28 x 1,75

COMPONENTS

HANDLEBAR	NR-AL -124BTFOV
HANDLEBAR STEM	ALUMINIUM 110 mm/31,8 REG
SEAT POST	AMORTIZED 31,6 x 350 mm
HEADSET	FSA C-40-ACB
SADDLE	SELLE ROYAL ESSENZA MOD W
GRIPS	VELO VLG-1670
PEDALS	FP-210
CARRIER	ATLAN VELO ALUMINIUM
FRONT LIGHT	SKS Edge
REAR LIGHT	SPANNINGA SOLO DYNAMO/EBIKE
MUDGUARDS	SKS EDGE
KICK STAND	ATLAN VELO
BATTERY	SHIMANO BT-E6000, 418Wh
ENGINE	SHIMANO STEPS E5000
DISPLAY	SHIMANO SC-E6100

GEOMETRY

SIZE	DM	DL	DXL
FS - FRAME SIZE*	19	21	22
ST - SEAT TUBE LENGTH**	490	530	570
TT - TOP TUBE LENGTH**	598	603	613
HT - HEAD TUBE LENGTH**	170	170	190
SA - SEAT TUBE ANGLE***	72	72	72
HA - HEAD TUBE ANGLE***	70	70	70
CS - CHAINSTAY LENGTH**	460	460	460
WB - WHEELBASE**	1104	1109	1119
REACH**	390	395	398
STACK**	641	641	660
BB DROP**	65	65	65

* dimension in inches, ** dimension in mm, *** dimension in degrees

SENTIO HYBRID 3.0



GEAR RATIO 1 x 7

WHEEL DIAMETER 28"

COLOUR VARIANTS



SKU	SIZE	COLOUR	FINISH
KRSH3Z28X22M007116	XL	brown	gloss
KRSH3Z28X24M007117	XXL	brown	gloss

FRAME

FRAME	ALUMINIUM PERFORMANCE
FORK	SR SUNTOUR NEX-E25
FORK TRAVEL	50 mm
SIZES	XL(22"), XXL(24")

DRIVETRAIN

REAR DERAILLEUR	SHIMANO DEORE T6000
FRONT BRAKE	SHIMANO MT200
REAR BRAKE	SHIMANO MT200
BRAKE LEVERS	SHIMANO MT200
BRAKE DISCS	SHIMANO RT10 160 CL
SHIFTERS	SHIMANO DEORE T6000
CRANKSET	FC-E5010
SPROCKETS	38T
CHAIN	E6090-10

WHEELS

FRONT HUB	HB-M4050
REAR HUB	SG-C3001-7D
RIMS	KROSS
TIRES	VREDESTEIN DYNAMIC 28 x 1,75

COMPONENTS

HANDLEBAR	NR-AL-124BTFOV
HANDLEBAR STEM	ALUMINIUM 110 mm/31,8 REG
SEAT POST	AMORTIZED 31,6 x 350 mm
HEADSET	FSA C-40-ACB
SADDLE	SELLE ROYAL ESSENZA MOD M
GRIPS	VELO VLG-1670
PEDALS	FP-210
CARRIER	ATRAN VELO ALUMINIUM
FRONT LIGHT	SKS Edge
REAR LIGHT	SPANNINGA SOLO DYNAMO/EBIKE
MUDGUARDS	SKS EDGE
KICK STAND	ATRAN VELO
BATTERY	SHIMANO BT-E6000, 418Wh
ENGINE	SHIMANO STEPS E5000
DISPLAY	SHIMANO SC-E6100

GEOMETRY

SIZE	XL	XXL
FS - FRAME SIZE*	22	24
ST - SEAT TUBE LENGTH**	570	610
TT - TOP TUBE LENGTH**	611	616
HT - HEAD TUBE LENGTH**	155	175
SA - SEAT TUBE ANGLE***	72	72
HA - HEAD TUBE ANGLE***	70	70
CS - CHAINSTAY LENGTH**	460	460
WB - WHEELBASE**	1116	1122
REACH**	407	406
STACK**	627	646
BB DROP**	65	65

* dimension in inches, ** dimension in mm, *** dimension in degrees

SENTIO HYBRID 3.0



SKU	SIZE	COLOUR	FINISH
KRSH3Z28X19W007113	DM	creamy	gloss
KRSH3Z28X21W007114	DL	creamy	gloss
KRSH3Z28X22W007115	DXL	creamy	gloss

GEAR RATIO 1 x 7

WHEEL DIAMETER 28"

COLOUR VARIANTS



FRAME

FRAME	ALUMINIUM PERFORMANCE
FORK	SR SUNTOUR NEX-E25
FORK TRAVEL	50 mm
SIZES	DM(19"), DL(21"), DXL(22")

DRIVETRAIN

REAR DERAILLEUR	SHIMANO DEORE T6000
FRONT BRAKE	SHIMANO MT200
REAR BRAKE	SHIMANO MT200
BRAKE LEVERS	SHIMANO MT200
BRAKE DISCS	SHIMANO RT10 160 CL
SHIFTERS	SHIMANO DEORE T6000
CRANKSET	FC-E5010
SPROCKETS	38T
CHAIN	E6090-10

WHEELS

FRONT HUB	HB-M4050
REAR HUB	SG-C3001-7D
RIMS	KROSS
TIRES	VREDESTEIN DYNAMIC 28 x 1,75

COMPONENTS

HANDLEBAR	NR-AL-124BTFOV
HANDLEBAR STEM	ALUMINIUM 110 mm/31,8 REG
SEAT POST	AMORTIZED 31,6 x 350 mm
HEADSET	FSA C-40-ACB
SADDLE	SELLE ROYAL ESSENZA MOD W
GRIPS	VELO VLG-1670
PEDALS	FP-210
CARRIER	ATRAN VELO ALUMINIUM
FRONT LIGHT	SKS Edge
REAR LIGHT	SPANNINGA SOLO DYNAMO/EBIKE
MUDGUARDS	SKS EDGE
KICK STAND	ATRAN VELO
BATTERY	SHIMANO BT-E6000, 418Wh
ENGINE	SHIMANO STEPS E5000
DISPLAY	SHIMANO SC-E6100

GEOMETRY

SIZE	DM	DL	DXL
FS - FRAME SIZE*	19	21	22
ST - SEAT TUBE LENGTH**	490	530	570
TT - TOP TUBE LENGTH**	598	603	613
HT - HEAD TUBE LENGTH**	170	170	190
SA - SEAT TUBE ANGLE***	72	72	72
HA - HEAD TUBE ANGLE***	70	70	70
CS - CHAINSTAY LENGTH**	460	460	460
WB - WHEELBASE**	1104	1109	1119
REACH**	390	395	398
STACK**	641	641	660
BB DROP**	65	65	65

* dimension in inches, ** dimension in mm, *** dimension in degrees

SENTIO HYBRID 2.0



SKU	SIZE	COLOUR	FINISH
KRSH2Z28X18U004392	S	coral-yellow	mat
KRSH2Z28X20U004393	M	coral-yellow	mat
KRSH2Z28X18U004394	S	silver-black	gloss
KRSH2Z28X20U004395	M	silver-black	gloss

GEAR RATIO 1 x 9

WHEEL DIAMETER 28"

COLOUR VARIANTS



FRAME

FRAME	ALUMINIUM
FORK	SR SUNTOUR NEX HLO
FORK TRAVEL	63 mm
SIZES	S(18"), M(20")

DRIVETRAIN

REAR DERAILLEUR	MICROSHIFT MEZZO M36S
FRONT BRAKE	POWER BH-M960
REAR BRAKE	POWER BH-M960
BRAKE LEVERS	POWER BH-M960
BRAKE DISCS	DISC (160 mm)
SHIFTERS	TS39-8
CRANKSET	WHEEL TOP
SPROCKETS	38T
BOTTOM BRACKET	FP-B902
CHAIN	YBN S9
CASSETTE/FREEWHEEL	SENSAH MTB-CR-HR9
CASSETTE/FREEWHEEL RANGE	11-32T

WHEELS

FRONT HUB	GL-B43F-DS
REAR HUB	GL-B43R-DS
RIMS	KROSS ALUMINIUM 622 x 19
TIRES	WANDA G5001 28 x 1,75

COMPONENTS

HANDLEBAR	ALUMINIUM 660 mm 31,8
HANDLEBAR STEM	ALUMINIUM 90 mm/31,8 REG
SEAT POST	AMORTIZED 31,6 x 350 mm
HEADSET	ALUMINIUM
SADDLE	SV353
GRIPS	HERRMANS
PEDALS	FP-910
CARRIER	BUCHEL ALUMINIUM - 25 kg
FRONT LIGHT	HERRMANS H-IKE BATTERY
REAR LIGHT	BUCHEL TIVOLI BATTERY
MUDGUARDS	TUBUS
KICK STAND	URSUS
BATTERY	PHYLION SR20
ENGINE	BAFANG G020.250.DC
DISPLAY	DISPLAY DP C11 CAN

GEOMETRY

SIZE	S	M
FS - FRAME SIZE*	18	20
ST - SEAT TUBE LENGTH**	457	508
TT - TOP TUBE LENGTH**	560	580
HT - HEAD TUBE LENGTH**	150	160
SA - SEAT TUBE ANGLE***	74	74
HA - HEAD TUBE ANGLE***	70	70
CS - CHAINSTAY LENGTH**	460	460
WB - WHEELBASE**	1086	1105
REACH**	382	400
STACK**	620	629
BB DROP**	60	60

* dimension in inches, ** dimension in mm, *** dimension in degrees

SENTIO HYBRID 1.0



SKU	SIZE	COLOUR	FINISH
KRSH1Z28X18U004388	S	pearly-black	gloss
KRSH1Z28X20U004389	M	pearly-black	gloss
KRSH1Z28X18U004390	S	black-silver	gloss
KRSH1Z28X20U004391	M	black-silver	gloss

GEAR RATIO 1 x 8

WHEEL DIAMETER 28"

COLOUR VARIANTS



FRAME

FRAME	ALUMINIUM
FORK	SR SUNTOUR NEX HLO
FORK TRAVEL	63 mm
SIZES	S(18"), M(20")

DRIVETRAIN

REAR DERAILLEUR	MICROSHIFT M26S
FRONT BRAKE	MECHANICAL DISC
REAR BRAKE	MECHANICAL DISC
BRAKE LEVERS	ALUMINIUM
BRAKE DISCS	DISC (160 mm)
SHIFTERS	TS-39-7
CRANKSET	WHEEL TOP
SPROCKETS	38T
BOTTOM BRACKET	FP-B902
CHAIN	KMC HV700
CASSETTE/FREEWHEEL	SUNRACE CSM66
CASSETTE/FREEWHEEL RANGE	11-32T

WHEELS

FRONT HUB	GL-B43F-DS
REAR HUB	GL-B43R-DS
RIMS	KROSS ALUMINIUM 622 x 19
TIRES	WANDA G5001 28 x 1,75

COMPONENTS

HANDLEBAR	ALUMINIUM 660 mm 31,8
HANDLEBAR STEM	ALUMINIUM 90 mm/31,8 REG
SEAT POST	ALUMINIUM 31,6 x 350 mm
HEADSET	ALUMINIUM
SADDLE	YIBOTONG YBT-K607
GRIPS	HERRMANS
PEDALS	FP-910
CARRIER	BUHEL ALUMINIUM - 25 kg
FRONT LIGHT	HERRMANS H-IKE BATTERY
MUDGUARDS	TUBUS
KICK STAND	URSUS
BATTERY	PHYLION SR20
ENGINE	BAFANG G020.250.DC
DISPLAY	DISPLAY DP C11 CAN

GEOMETRY

SIZE	S	M
FS - FRAME SIZE*	18	20
ST - SEAT TUBE LENGTH**	457	508
TT - TOP TUBE LENGTH**	560	580
HT - HEAD TUBE LENGTH**	150	160
SA - SEAT TUBE ANGLE***	74	74
HA - HEAD TUBE ANGLE***	70	70
CS - CHAINSTAY LENGTH**	460	460
WB - WHEELBASE**	1086	1105
REACH**	382	400
STACK**	620	629
BB DROP**	60	60

* dimension in inches, ** dimension in mm, *** dimension in degrees

SENTIO HYBRID ZZ



SKU	SIZE	COLOUR	FINISH
KRSHZZ28X18U004413	S	khaki-khaki	mat
KRSHZZ28X20U004414	M	khaki-khaki	mat
KRSHZZ28X18U004415	S	purple-lime	gloss
KRSHZZ28X20U004416	M	purple-lime	gloss
KRSHZZ28X18U004419	S	blue	gloss
KRSHZZ28X20U004420	M	blue	gloss
KRSHZZ28X18U004417	S	navy blue-steel	gloss
KRSHZZ28X20U004418	M	navy blue-steel	gloss

GEAR RATIO 1 x 7

WHEEL DIAMETER 28"

COLOUR VARIANTS



FRAME

FRAME	ALUMINIUM
FORK	SR SUNTOUR NEX
FORK TRAVEL	63 mm
SIZES	S(18"), M(20")

DRIVETRAIN

REAR DERAILLEUR	LTWOO RD-V4007-M
FRONT BRAKE	MECHANICAL DISC
REAR BRAKE	MECHANICAL DISC
BRAKE LEVERS	ALUMINIUM
SHIFTERS	KRX2 7S
CRANKSET	PROWHEEL
SPROCKETS	38T/170 mm
BOTTOM BRACKET	FP-B902-2S
CHAIN	KMC HV500
CASSETTE/FREEWHEEL	SHIMANO TOURNEY MF-TZ500
CASSETTE/FREEWHEEL RANGE	14-28T

WHEELS

FRONT HUB	GL-B01F-QR
RIMS	KROSS ALUMINIUM 622 x 19
TIRES	WANDA G5001 28 x 1,75

COMPONENTS

HANDLEBAR	STEEL 610 mm 25.4
HANDLEBAR STEM	ALUMINIUM 110/25,4 REG
SEAT POST	AMORTIZED 31,6 x 350 mm
HEADSET	ALUMINIUM
SADDLE	YIBOTONG YBT-K607
GRIPS	KROSS GRIPEN
PEDALS	FP-910
CARRIER	BUCHEL ALUMINIUM 28" 25 kg
FRONT LIGHT	HERRMANS H-IKE BATTERY
REAR LIGHT	BUCHEL TIVOLI BATTERY
MUDGUARDS	SIMPLA
KICK STAND	URSUS
BATTERY	GREENWAY 360 WH, 10AH
ENGINE	SHENGYI DGWH2S; REAR;
DISPLAY	SHENGYI LCD, ETD-21C LCD

GEOMETRY

SIZE	S	M
FS - FRAME SIZE*	18	20
ST - SEAT TUBE LENGTH**	460	510
TT - TOP TUBE LENGTH**	560	580
HT - HEAD TUBE LENGTH**	150	160
SA - SEAT TUBE ANGLE***	74	74
HA - HEAD TUBE ANGLE***	70	70
CS - CHAINSTAY LENGTH**	460	460
WB - WHEELBASE**	1086	1105
REACH**	382	400
STACK**	620	629
BB DROP**	60	60

* dimension in inches, ** dimension in mm, *** dimension in degrees

ELILLE 3



GEAR RATIO 1 x 7

WHEEL DIAMETER 28"

COLOUR VARIANTS



SKU	SIZE	COLOUR	FINISH
LGLHZ328X17W006564	DM	cherry-white	gloss
LGLHZ328X19W006565	DL	cherry-white	gloss

FRAME

FRAME	ALUMINIUM PERFORMANCE
FORK	SR SUNTOUR CR8V
FORK TRAVEL	40mm
SIZES	DM(17"), DL(19")

DRIVETRAIN

REAR DERAILLEUR	SHIMANO NEXUS
FRONT BRAKE	V-BRAKE
REAR BRAKE	V-BRAKE
BRAKE LEVERS	ALUMINIUM
SHIFTERS	SHIMANO NEXUS
CRANKSET	CYCLONE
SPROCKETS	38T/170 mm
BOTTOM BRACKET	FP-B902
CHAIN	SHIMANO NX10
CASSETTE/FREEWHEEL	SHIMANO
CASSETTE/FREEWHEEL RANGE	22T

WHEELS

FRONT HUB	ALUMINIUM
REAR HUB	SHIMANO NEXUS NEXUS SG-C3000
RIMS	KROSS ALUMINIUM 622 x 19
TIRES	WANDA G5001 28 x 1,75

COMPONENTS

HANDLEBAR	ALUMINIUM 610 mm 25.4
HANDLEBAR STEM	ALUMINIUM 90/25,4 REG
SEAT POST	AMORTIZED 27,2 x 350 mm
HEADSET	FP-H815 O1-1/8"
SADDLE	VELO VL-6049
GRIPS	SYNTHETIC LEATHER
PEDALS	FP-920
CARRIER	INTEGRATED
FRONT LIGHT	BUCHEL RETRO DYNAMO/EBIKE
REAR LIGHT	BUCHEL BROADWAY DYNAMO/EBIKE
MUDGUARDS	KROSS
KICK STAND	KROSS
BATTERY	BAFANG 43V/10.4Ah
ENGINE	BAFANG 36V/250W
DISPLAY	BAFANG DP C07.UART LCD DP C07

GEOMETRY

SIZE	DM	DL
FS - FRAME SIZE*	17	19
ST - SEAT TUBE LENGTH**	430	480
TT - TOP TUBE LENGTH**	600	615
HT - HEAD TUBE LENGTH**	150	160
SA - SEAT TUBE ANGLE***	71	71
HA - HEAD TUBE ANGLE***	69	69
CS - CHAINSTAY LENGTH**	482	485
WB - WHEELBASE**	1126	1141
REACH**	385	397
STACK**	625	634
BB DROP**	60	60

* dimension in inches, ** dimension in mm, *** dimension in degrees

ELILLE 2



GEAR RATIO 1 x 7

WHEEL DIAMETER 28"

COLOUR VARIANTS



SKU	SIZE	COLOUR	FINISH
LGLHZ228X17W006562	DM	turquoise-white	mat
LGLHZ228X19W006563	DL	turquoise-white	mat

FRAME

FRAME	ALUMINIUM PERFORMANCE
FORK	KROSS
FORK TRAVEL	50 mm
SIZES	DM(17"), DL(19")

DRIVETRAIN

REAR DERAILLEUR	SHIMANO NEXUS
FRONT BRAKE	V-BRAKE
REAR BRAKE	V-BRAKE
BRAKE LEVERS	ALUMINIUM
SHIFTERS	SHIMANO NEXUS
CRANKSET	WHEEL TOP SIC2F6P-MZ
SPROCKETS	38T/170 mm
BOTTOM BRACKET	FP-B902
CHAIN	KMC HV410
CASSETTE/FREEWHEEL	SHIMANO
CASSETTE/FREEWHEEL RANGE	19T

WHEELS

FRONT HUB	BAFANG FM G310.250.V
REAR HUB	SHIMANO NEXUS NEXUS SG-C3000
RIMS	KROSS ALUMINIUM 622 x 19
TIRES	WANDA G5001 28 x 1,75

COMPONENTS

HANDLEBAR	ALUMINIUM 610 mm 25.4
HANDLEBAR STEM	ALUMINIUM 90/25,4 REG
SEAT POST	AMORTIZED 27,2 x 350 mm
HEADSET	FP-H815 O1-1/8"
SADDLE	VELO VL-6049
GRIPS	SYNTHETIC LEATHER
PEDALS	FP-920
CARRIER	INTEGRATED
FRONT LIGHT	BUHEL RETRO DYNAMO/EBIKE
REAR LIGHT	BUHEL ROUTE 66 DYNAMO
MUDGUARDS	KROSS
KICK STAND	KROSS
BATTERY	BAFANG 43V/10.4Ah
ENGINE	BAFANG 36V/250W
DISPLAY	BAFANG DP C10, UART

GEOMETRY

SIZE	DM	DL
FS - FRAME SIZE*	17	19
ST - SEAT TUBE LENGTH**	430	480
TT - TOP TUBE LENGTH**	600	615
HT - HEAD TUBE LENGTH**	150	160
SA - SEAT TUBE ANGLE***	71	71
HA - HEAD TUBE ANGLE***	69	69
CS - CHAINSTAY LENGTH**	485	485
WB - WHEELBASE**	1119	1134
REACH**	380	392
STACK**	640	650
BB DROP**	75	75

* dimension in inches, ** dimension in mm, *** dimension in degrees

ELILLE 1



SKU	SIZE	COLOUR	FINISH
LGLHZ128X17W006560	DM	blue-turquoise	gloss
LGLHZ128X19W006561	DL	blue-turquoise	gloss

GEAR RATIO 1 x 7

WHEEL DIAMETER 28"

COLOUR VARIANTS



FRAME

FRAME	ALUMINIUM PERFORMANCE
FORK	KROSS
FORK TRAVEL	50 mm
SIZES	DM(17"), DL(19")

DRIVETRAIN

REAR DERAILLEUR	SHIMANO NEXUS
FRONT BRAKE	V-BRAKE
REAR BRAKE	V-BRAKE
BRAKE LEVERS	ALUMINIUM
SHIFTERS	SHIMANO NEXUS
CRANKSET	WHEEL TOP SIC2F6P-MZ
SPROCKETS	38T/170 mm
BOTTOM BRACKET	FP-B902
CHAIN	KMC HV410
CASSETTE/FREEWHEEL	SHIMANO
CASSETTE/FREEWHEEL RANGE	19T

WHEELS

FRONT HUB	BAFANG FM G310.250.V
REAR HUB	SHIMANO NEXUS NEXUS SG-3R40
RIMS	KROSS ALUMINIUM 622 x 19
TIRES	WANDA G5001 28 x 1,75

COMPONENTS

HANDLEBAR	ALUMINIUM 610 mm 25,4
HANDLEBAR STEM	ALUMINIUM 110/25,4 REG
SEAT POST	AMORTIZED 27,2 x 350 mm
HEADSET	FP-H815 O1-1/8"
SADDLE	VELO VL-6049
GRIPS	SYNTHETIC LEATHER
PEDALS	FP-920
CARRIER	INTEGRATED
FRONT LIGHT	BUHEL RETRO DYNAMO/EBIKE
REAR LIGHT	BUHEL ROUTE 66 DYNAMO
MUDGUARDS	KROSS
KICK STAND	KROSS
BATTERY	BAFANG 43V/7.8Ah
ENGINE	BAFANG BAGA=NIK 43V/450W
DISPLAY	BAFANG DP E10.UART

GEOMETRY

SIZE	DM	DL
FS - FRAME SIZE*	17	19
ST - SEAT TUBE LENGTH**	430	480
TT - TOP TUBE LENGTH**	600	615
HT - HEAD TUBE LENGTH**	150	160
SA - SEAT TUBE ANGLE***	71	71
HA - HEAD TUBE ANGLE***	69	69
CS - CHAINSTAY LENGTH**	485	485
WB - WHEELBASE**	1119	1134
REACH**	380	392
STACK**	640	650
BB DROP**	75	75

* dimension in inches, ** dimension in mm, *** dimension in degrees

INZAI HYBRID 2.0



FRAME

FRAME	ALUMINIUM
FORK	ALUMINIUM
SIZES	M(19"), L(21")

DRIVETRAIN

REAR DERAILLEUR	SHIMANO DEORE M592
FRONT BRAKE	SHIMANO UR300
REAR BRAKE	SHIMANO BR-UR300
BRAKE LEVERS	SHIMANO MT200
BRAKE DISCS	SHIMANO ALIVIO M3100
SHIFTERS	SHIMANO ALIVIO M3100
CRANKSET	ALUMINIUM
SPROCKETS	42T/170 mm
BOTTOM BRACKET	HYENA
CHAIN	SHIMANO HG53
CASSETTE/FREEWHEEL	SHIMANO ALTUS HG200
CASSETTE/FREEWHEEL RANGE	11-36T

WHEELS

FRONT HUB	GL-B43F-DS
REAR HUB	GL-B43R-DS
RIMS	KROSS ALUMINIUM 622 x 19
TIRES	SCHWALBE SPICER 28 x 1,5

COMPONENTS

HANDLEBAR	ALUMINIUM 620 mm 31.8
HANDLEBAR STEM	ALUMINIUM 90 mm/31.8/7°
SEAT POST	ALUMINIUM 27,2 x 300 mm
HEADSET	ALUMINIUM
SADDLE	VELO VL-1356
GRIPS	KROSS
PEDALS	FP-210ZU
BATTERY	HYENA GIRAFFE
ENGINE	HYENA MRC-250
DISPLAY	HYENA LCD COMPACT EX

GEOMETRY

SIZE	M	L
FS - FRAME SIZE*	19	21
ST - SEAT TUBE LENGTH**	475	525
TT - TOP TUBE LENGTH**	580	605
HT - HEAD TUBE LENGTH**	160	190
SA - SEAT TUBE ANGLE***	73	73
HA - HEAD TUBE ANGLE***	70,5	70,5
CS - CHAINSTAY LENGTH**	445	445
WB - WHEELBASE**	1080	1107
REACH**	403	420
STACK**	578	606
BB DROP**	60	60

* dimension in inches, ** dimension in mm, *** dimension in degrees

GEAR RATIO 1 x 9

WHEEL DIAMETER 28"

COLOUR VARIANTS



SKU	SIZE	COLOUR	FINISH
KRIH2Z28X19M001082	M	black	gloss
KRIH2Z28X21M001083	L	black	gloss



CARGO BIKES

E-CARGO

KROSS Cargo 1.0 and 0.5, are innovative cargo bikes designed for transporting heavy goods in urban and suburban environments. It is a bicycle that is popular among couriers, suppliers, families with kids and individuals who need a practical means of transport for carrying a variety of items.

Efficient drivetrain: our Cargo bikes are equipped with an efficient Shimano drive system with the option for 2 batteries, allowing for smooth and long rides even when carrying heavy cargo.

In harmony with nature: Cargo bike, is an environmentally friendly means of transportation that allows you to avoid congested roads, reduce emissions and and utilise urban cycling infrastructure.





E-CARGO 0.5 BUSINESS ALU



SKU	BATTERY	SIZE	COLOUR	FINISH
KRECBAMUX19U007567	1 BATTERY	OS	white	gloss
KRECBAMUX19U007568	1 BATTERY	OS	green	gloss
KRECPFMUX19U007565	2 BATTERIES	OS	white	gloss
KRECBAMUX19U007570	2 BATTERIES	OS	green	gloss

GEAR RATIO 1 x 10
WHEEL DIAMETER MU
COLOUR VARIANTS

FRAME

FRAME	ALUMINIUM
FORK	ALUMINIUM
SIZES	OS(19")

DRIVETRAIN

REAR DERAILLEUR	MICROSHIFT ADVENTX
FRONT BRAKE	SHIMANO MT500
REAR BRAKE	SHIMANO MT520
BRAKE LEVERS	SHIMANO MT520
BRAKE DISCS	SHIMANO RT10 (180)
SHIFTERS	MICROSHIFT ADVENTX
CRANKSET	FSA-CK751
SPROCKETS	38T
CHAIN	SHIMANO CN-E6090-10
CASSETTE/FREEWHEEL	10 IN-LINE
CASSETTE/FREEWHEEL RANGE	11-48T

WHEELS

FRONT HUB	SHIMANO HB-MT200
REAR HUB	SHIMANO MT400 12 x 148
RIMS	RYDE ANDRA
TIRES	SCHWALBE PICK UP 20 x 2,15

COMPONENTS

HANDLEBAR	ALUMINIUM 660 mm 31,8
HANDLEBAR STEM	ALUMINIUM 90 mm/31,8 REG
SEAT POST	AMORTIZED 31,6 x 300 mm
HEADSET	FP-H856B2;1-1/8"-1.5"
SADDLE	SELLE ROYAL FREEWAY 8494
GRIPS	PROPALM GRIPPEN
PEDALS	FP-210
CARRIER	RACKTIME ALUMINIUM 26" 25 kg
FRONT LIGHT	B&M MYC DYNAMO/EBIKE
REAR LIGHT	SPANNINGA PIMENTO DYNAMO/EBIKE
MUDGUARDS	EUROFENDER
KICK STAND	KROSS CARGO CUSTOM
BATTERY	SHIMANO BT-E8016 630WH
ENGINE	SHIMANO E8000
DISPLAY	SHIMANO SC-E6100C

GEOMETRY

SIZE	OS
FS - FRAME SIZE*	19
ST - SEAT TUBE LENGTH**	484
TT - TOP TUBE LENGTH**	580
HT - HEAD TUBE LENGTH**	115
SA - SEAT TUBE ANGLE***	73,5
HA - HEAD TUBE ANGLE***	70
CS - CHAINSTAY LENGTH**	422
WB - WHEELBASE**	1858
REACH**	430
STACK**	505
BB DROP**	40

* dimension in inches, ** dimension in mm, *** dimension in degrees

E-CARGO 0.5 FAMILY



SKU	BATTERY	SIZE	COLOUR	FINISH
KRECFMUX19U007571	1 BATTERY	OS	white	gloss
KRECFMUX19U007572	1 BATTERY	OS	green	gloss
KRECFMUX19U007573	2 BATTERIES	OS	white	gloss
KRECFMUX19U007574	2 BATTERIES	OS	green	gloss

GEAR RATIO 1 x 10
WHEEL DIAMETER MU
COLOUR VARIANTS



FRAME

FRAME	ALUMINIUM
FORK	ALUMINIUM
SIZES	OS(19")

DRIVETRAIN

REAR DERAILLEUR	MICROSHIFT ADVENTX
FRONT BRAKE	SHIMANO MT520
REAR BRAKE	SHIMANO MT520
BRAKE LEVERS	SHIMANO MT520
BRAKE DISCS	SHIMANO RT10 (180)
SHIFTERS	MICROSHIFT ADVENTX
CRANKSET	FSA-CK751
SPROCKETS	38T
CHAIN	SHIMANO CN-E6090-10
CASSETTE/FREEWHEEL	10 IN-LINE
CASSETTE/FREEWHEEL RANGE	11-48T

WHEELS

FRONT HUB	SHIMANO HB-MT200
REAR HUB	SHIMANO MT400 12 x 148
RIMS	RYDE ANDRA
TIRES	SCHWALBE BICK UP

COMPONENTS

HANDLEBAR	ERGOTEC 31.8
HANDLEBAR STEM	AS-831; 31,8
SEAT POST	SPS-C372;Q31;6 x 300
HEADSET	FP-H856B2;1-1/8"-1.5"
SADDLE	SELLE ROYAL
GRIPS	PROPALM GRIPPEN
PEDALS	FEIMIN FP210
CARRIER	RACKTIME BASIC
FRONT LIGHT	B&M MYC
REAR LIGHT	SPANNINGA PIMENTO
MUDGUARDS	EUROFENDER
KICK STAND	KROSS CARGO CUSTOM
BATTERY	SHIMANO BT-E8016 630WH
ENGINE	SHIMANO E8000
DISPLAY	SHIMANO SC-E6100C

GEOMETRY

SIZE	OS
FS - FRAME SIZE*	19
ST - SEAT TUBE LENGTH**	484
TT - TOP TUBE LENGTH**	550
HT - HEAD TUBE LENGTH**	115
SA - SEAT TUBE ANGLE***	73,5
HA - HEAD TUBE ANGLE***	70
CS - CHAINSTAY LENGTH**	420
WB - WHEELBASE**	1870
REACH**	430
STACK**	500
BB DROP**	40

* dimension in inches, ** dimension in mm, *** dimension in degrees

E-CARGO BUSINESS ALU 1.0



SKU	BATTERY	SIZE	COLOUR	FINISH
KRCBA1MUX19U006592	1 BATTERY	OS	black-white	gloss
KRCBA1MUX19U006593	1 BATTERY	OS	green	gloss
KRCBA1MUX19U006594	2 BATTERIES	OS	black-white	gloss
KRCBA1MUX19U006595	2 BATTERIES	OS	green	gloss

GEAR RATIO 1 x 11

WHEEL DIAMETER MU

COLOUR VARIANTS



FRAME

FRAME	ALUMINIUM
FORK	ALUMINIUM
SIZES	OS(19")

DRIVETRAIN

REAR DERAILLEUR	SHIMANO XT M8000
FRONT BRAKE	SHIMANO MT500
REAR BRAKE	SHIMANO MT520
BRAKE LEVERS	SHIMANO SLX M7000
BRAKE DISCS	SHIMANO RT10 180 CL
SHIFTERS	SHIMANO SLX M7000
CRANKSET	FSA ALU
SPROCKETS	38T
CHAIN	SHIMANO
CASSETTE/FREEWHEEL	SHIMANO
CASSETTE/FREEWHEEL RANGE	11-42T

WHEELS

FRONT HUB	SHIMANO HB-MT200
REAR HUB	SHIMANO ALIVIO MT400
RIMS	RYDE ANDRA 40 406 x 25
TIRES	SCHWALBE PICK UP 20 x 2,15

COMPONENTS

HANDLEBAR	ALUMINIUM 660 mm 31,8
HANDLEBAR STEM	ALUMINIUM 90 mm/31,8 REG
SEAT POST	AMORTIZED 31,6 x 300 mm
HEADSET	FP-H801S 1-1/8"
SADDLE	FIZIK ARGOVENTO R5
GRIPS	FIZIK TERRA MICROTEX
BATTERY	SHIMANO BT-EN606 630WH
ENGINE	SHIMANO EP801-CRG
DISPLAY	SHIMANO SC-EN610

GEOMETRY

SIZE	OS
FS - FRAME SIZE*	19
ST - SEAT TUBE LENGTH**	484
TT - TOP TUBE LENGTH**	580
HT - HEAD TUBE LENGTH**	115
SA - SEAT TUBE ANGLE***	73,5
HA - HEAD TUBE ANGLE***	70
CS - CHAINSTAY LENGTH**	422
WB - WHEELBASE**	1858
REACH**	430
STACK**	505
BB DROP**	40

* dimension in inches, ** dimension in mm, *** dimension in degrees

E-CARGO FAMILY 1.0



SKU	BATTERY	SIZE	COLOUR	FINISH
KRCF1ZMUX19U006608	1 BATTERY	OS	black-white	gloss
KRCF1ZMUX19U006609	1 BATTERY	OS	green	gloss
KRCF1ZMUX19U006610	2 BATTERIES	OS	black-white	gloss
KRCF1ZMUX19U006611	2 BATTERIES	OS	green	gloss

GEAR RATIO 1 x 11

WHEEL DIAMETER MU

COLOUR VARIANTS



FRAME

FRAME	ALUMINIUM
FORK	ALUMINIUM
SIZES	OS(19")

DRIVETRAIN

REAR DERAILLEUR	SHIMANO XT M8000
FRONT BRAKE	SHIMANO MT500
REAR BRAKE	SHIMANO MT520
BRAKE LEVERS	SHIMANO SLX M7000
BRAKE DISCS	SHIMANO RT10 180 CL
SHIFTERS	SHIMANO SLX M7000
CRANKSET	FSA ALU
SPROCKETS	38T
CHAIN	SHIMANO
CASSETTE/FREEWHEEL	SHIMANO
CASSETTE/FREEWHEEL RANGE	11-42T

WHEELS

FRONT HUB	SHIMANO HB-MT200
REAR HUB	SHIMANO ALIVIO MT400
RIMS	RYDE ANDRA 40 406 x 25
TIRES	SCHWALBE PICK UP 20 x 2,15

COMPONENTS

HANDLEBAR	ALUMINIUM 660 mm 31,8
HANDLEBAR STEM	ALUMINIUM 90 mm/31,8 REG
SEAT POST	AMORTIZED 31,6 x 300 mm
HEADSET	FP-H801S 1-1/8"
SADDLE	SELLE ROYAL FREEWAY 8494
GRIPS	PROPALM GRIPPEN
PEDALS	FP-210
CARRIER	RACKTIME ALUMINIUM 26" 25 kg
FRONT LIGHT	B&M MYC DYNAMO/EBIKE
REAR LIGHT	SPANNINGA PIMENTO DYNAMO/EBIKE
MUDGUARDS	EUROFENDER TW. SZT. CARGO
KICK STAND	KROSS CARGO CUSTOM ALUMINIUM
BATTERY	SHIMANO BT-EN606 630WH
ENGINE	SHIMANO EP801-CRG
DISPLAY	SHIMANO SC-EN610

GEOMETRY

SIZE	OS
FS - FRAME SIZE*	19
ST - SEAT TUBE LENGTH**	484
TT - TOP TUBE LENGTH**	580
HT - HEAD TUBE LENGTH**	115
SA - SEAT TUBE ANGLE***	73,5
HA - HEAD TUBE ANGLE***	70
CS - CHAINSTAY LENGTH**	422
WB - WHEELBASE**	1858
REACH**	430
STACK**	505
BB DROP**	40

* dimension in inches, ** dimension in mm, *** dimension in degrees

E-CARGO PLATFORM 0.5



GEAR RATIO 1 x 10
WHEEL DIAMETER MU
COLOUR VARIANTS



SKU	BATTERY	SIZE	COLOUR	FINISH
KRECPFMUX19U007563	1 BATTERY	OS	white	gloss
KRECPFMUX19U007564	1 BATTERY	OS	green	gloss
KRECPFMUX19U007566	2 BATTERIES	OS	green	gloss

FRAME

FRAME	ALUMINIUM
FORK	ALUMINIUM
SIZES	OS(19")

DRIVETRAIN

REAR DERAILLEUR	MICROSHIFT ADVENTX
FRONT BRAKE	SHIMANO MT500
REAR BRAKE	SHIMANO MT520
BRAKE LEVERS	SHIMANO MT520
BRAKE DISCS	SHIMANO RT10 (180)
SHIFTERS	MICROSHIFT ADVENTX
CRANKSET	FSA-CK751
SPROCKETS	38T
CHAIN	SHIMANO CN-E6090-10
CASSETTE/FREEWHEEL	10 IN-LINE
CASSETTE/FREEWHEEL RANGE	11-48T

WHEELS

FRONT HUB	SHIMANO HB-MT200
REAR HUB	SHIMANO MT400 12 x 148
RIMS	RYDE ANDRA
TIRES	SCHWALBE PICK UP 20 x 2,15

COMPONENTS

HANDLEBAR	ALUMINIUM 660 mm 31,8
HANDLEBAR STEM	ALUMINIUM 90 mm/31,8 REG
SEAT POST	AMORTIZED 31,6 x 300 mm
HEADSET	FP-H856B2;1-1/8"-1.5"
SADDLE	SELLE ROYAL FREEWAY 8494
GRIPS	PROPALM GRIPPEN
PEDALS	FP-210
CARRIER	RACKTIME ALUMINIUM 26" 25 kg
FRONT LIGHT	B&M MYC DYNAMO/EBIKE
REAR LIGHT	SPANNINGA PIMENTO DYNAMO/EBIKE
MUDGUARDS	EUROFENDER
KICK STAND	KROSS CARGO CUSTOM
BATTERY	SHIMANO BT-E8016 630WH
ENGINE	SHIMANO E8000
DISPLAY	SHIMANO SC-E6100C

GEOMETRY

SIZE	OS
FS - FRAME SIZE*	19
ST - SEAT TUBE LENGTH**	484
TT - TOP TUBE LENGTH**	580
HT - HEAD TUBE LENGTH**	115
SA - SEAT TUBE ANGLE***	73,5
HA - HEAD TUBE ANGLE***	70
CS - CHAINSTAY LENGTH**	422
WB - WHEELBASE**	1858
REACH**	430
STACK**	505
BB DROP**	40

* dimension in inches, ** dimension in mm, *** dimension in degrees

E-CARGO PLATFORM 1.0



SKU	BATTERY	SIZE	COLOUR	FINISH
KRCP1ZMUX19U006627	1 BATTERY	OS	black-white	gloss
KRCP1ZMUX19U006628	1 BATTERY	OS	green	gloss
KRCP1ZMUX19U006629	2 BATTERIES	OS	black-white	gloss
KRCP1ZMUX19U006630	2 BATTERIES	OS	green	gloss

GEAR RATIO 1 x 11
WHEEL DIAMETER MU
COLOUR VARIANTS



FRAME

FRAME	ALUMINIUM
FORK	ALUMINIUM
SIZES	OS(19")

DRIVETRAIN

REAR DERAILLEUR	SHIMANO XT M8000
FRONT BRAKE	SHIMANO MT500
REAR BRAKE	SHIMANO MT520
BRAKE LEVERS	SHIMANO SLX M7000
BRAKE DISCS	SHIMANO RT10 180 CL
SHIFTERS	SHIMANO SLX M7000
CRANKSET	FSA ALU
SPROCKETS	38T
CHAIN	SHIMANO
CASSETTE/FREEWHEEL	SHIMANO
CASSETTE/FREEWHEEL RANGE	11-42T

WHEELS

FRONT HUB	SHIMANO HB-MT200
REAR HUB	SHIMANO ALIVIO MT400
RIMS	RYDE ANDRA 40 406 x 25
TIRES	SCHWALBE PICK UP 20 x 2,15

COMPONENTS

HANDLEBAR	ALUMINIUM 660 mm 31,8
HANDLEBAR STEM	ALUMINIUM 90 mm/31,8 REG
SEAT POST	AMORTIZED 31,6 x 300 mm
HEADSET	FP-H801S 1-1/8"
SADDLE	SELLE ROYAL FREEWAY 8494
GRIPS	PROPALM GRIPPEN
PEDALS	FP-210
CARRIER	RACKTIME ALUMINIUM 26" 25 kg
FRONT LIGHT	B&M MYC DYNAMO/EBIKE
REAR LIGHT	SPANNINGA PIMENTO DYNAMO/EBIKE
MUDGUARDS	EUROFENDER TW. SZT. CARGO
KICK STAND	KROSS CARGO CUSTOM ALUMINIUM
BATTERY	SHIMANO BT-EN606 630WH
ENGINE	SHIMANO EP801-CRG
DISPLAY	SHIMANO SC-EN610

GEOMETRY

SIZE	OS
FS - FRAME SIZE*	19
ST - SEAT TUBE LENGTH**	484
TT - TOP TUBE LENGTH**	580
HT - HEAD TUBE LENGTH**	115
SA - SEAT TUBE ANGLE***	73,5
HA - HEAD TUBE ANGLE***	70
CS - CHAINSTAY LENGTH**	422
WB - WHEELBASE**	1858
REACH**	430
STACK**	505
BB DROP**	40

* dimension in inches, ** dimension in mm, *** dimension in degrees

JUNIOR & KID BIKES

JUNIOR & KID

Junior and Kid are series of bikes for children and young people, designed to provide extraordinary fun and adventure while riding over diverse terrain.

With their user-friendly design and practical solutions, they enable exciting rides on trails during holiday adventures, or daily rides.

These bikes nurture a passion for physical activity and allow for the creation of beautiful cycling memories.





LEVEL JR 6.0



GEAR RATIO 1 x 11

WHEEL DIAMETER 27,5"

COLOUR VARIANTS



SKU	SIZE	COLOUR	FINISH
KRLVJ627X14M005182	S	blue-black	gloss

FRAME

FRAME	ALUMINIUM PERFORMANCE
FORK	SR SUNTOUR XCR32 AIR LOR
FORK TRAVEL	100 mm
SIZES	S(14")

DRIVETRAIN

REAR DERAILLEUR	SHIMANO DEORE M5120
FRONT BRAKE	SHIMANO MT200
REAR BRAKE	SHIMANO MT200
BRAKE LEVERS	SHIMANO MT200
BRAKE DISCS	SHIMANO RT10 160 CL
SHIFTERS	SHIMANO DEORE M5100
CRANKSET	PROWHEEL CHARM-FD04S-TT; 165 mm
SPROCKETS	32T
BOTTOM BRACKET	PROWHEEL PW-BB68+
CHAIN	SHIMANO HG601
CASSETTE/FREEWHEEL	SHIMANO DEORE M5100
CASSETTE/FREEWHEEL RANGE	11-42T

WHEELS

FRONT HUB	SHIMANO TX505
REAR HUB	SHIMANO TX505
RIMS	KROSS ALUMINIUM 584 x 25
TIRES	SCHWALBE SMART SAM 27,5 x 2,25

COMPONENTS

HANDLEBAR	ALUMINIUM 640 mm 31,8
HANDLEBAR STEM	ALUMINIUM 70 mm/31,8/7°
SEAT POST	ALUMINIUM 27,2 x 300 mm
HEADSET	FP-H813PL 1-1/8"
SADDLE	SELLE ROYAL EXPLORA JRN
GRIPS	KROSS SCALE
PEDALS	FP-917N

GEOMETRY

SIZE	S
FS - FRAME SIZE*	14
ST - SEAT TUBE LENGTH**	345
TT - TOP TUBE LENGTH**	535
HT - HEAD TUBE LENGTH**	90
SA - SEAT TUBE ANGLE***	74
HA - HEAD TUBE ANGLE***	69
CS - CHAINSTAY LENGTH**	430
WB - WHEELBASE**	1041
REACH**	366
STACK**	571
BB DROP**	50

* dimension in inches, ** dimension in mm, *** dimension in degrees

LEVEL JR 5.0



GEAR RATIO 1 x 10

WHEEL DIAMETER 26"

COLOUR VARIANTS



SKU	SIZE	COLOUR	FINISH
KRLV5R26X13M006559	S	turquoise-orange	gloss

FRAME

FRAME	ALUMINIUM PERFORMANCE
FORK	SR SUNTOUR XCR32 AIR LOR
FORK TRAVEL	100 mm
SIZES	S(13")

DRIVETRAIN

REAR DERAILLEUR	SHIMANO DEORE M5120
FRONT BRAKE	SHIMANO MT200
REAR BRAKE	SHIMANO MT200
BRAKE LEVERS	SHIMANO BL-MT200
BRAKE DISCS	SHIMANO RT10 160 CL
SHIFTERS	SHIMANO DEORE M6000
CRANKSET	PROWHEEL CHARM-FD04S-TT; 155 mm
SPROCKETS	30T
BOTTOM BRACKET	PROWHEEL PW-BB68+
CHAIN	SHIMANO HG54
CASSETTE/FREEWHEEL	SHIMANO CS-HG500-10
CASSETTE/FREEWHEEL RANGE	11-42T

WHEELS

FRONT HUB	SHIMANO TX505
REAR HUB	SHIMANO TX505
RIMS	KROSS ALUMINIUM 559 x 25
TIRES	SCHWALBE SMART SAM 26 x 2,1

COMPONENTS

HANDLEBAR	ALUMINIUM 640 mm 31,8
HANDLEBAR STEM	ALUMINIUM 70 mm/31,8/7°
SEAT POST	ALUMINIUM 27,2 x 300 mm
HEADSET	FP-H813PL 1-1/8"
SADDLE	SELLE ROYAL EXPLORA JRN
GRIPS	KROSS SCALE
PEDALS	FP-917N

GEOMETRY

SIZE	S
FS - FRAME SIZE*	13
ST - SEAT TUBE LENGTH**	320
TT - TOP TUBE LENGTH**	520
HT - HEAD TUBE LENGTH**	90
SA - SEAT TUBE ANGLE***	74
HA - HEAD TUBE ANGLE***	69
CS - CHAINSTAY LENGTH**	425
WB - WHEELBASE**	1021
REACH**	359
STACK**	545
BB DROP**	45

* dimension in inches, ** dimension in mm, *** dimension in degrees

LEVEL JR 4.0



GEAR RATIO 1 x 9

WHEEL DIAMETER 24"

COLOUR VARIANTS



SKU	SIZE	COLOUR	FINISH
KRLVJ424X12U007251	OS	orange	gloss

FRAME

FRAME	ALUMINIUM
FORK	SR SUNTOUR XCR AIR RLR
FORK TRAVEL	63mm
SIZES	OS(12")

DRIVETRAIN

REAR DERAILLEUR	SHIMANO ALIVIO M3100
FRONT BRAKE	SHIMANO MT200
REAR BRAKE	SHIMANO MT200
BRAKE LEVERS	SHIMANO MT200
BRAKE DISCS	POWER RT600 160 6B
SHIFTERS	SHIMANO ALIVIO M3100
CRANKSET	WHEEL TOP SR-11
SPROCKETS	32T/152 mm
BOTTOM BRACKET	FP-B902
CHAIN	SHIMANO HG53
CASSETTE/FREEWHEEL	SHIMANO ALTUS HG200
CASSETTE/FREEWHEEL RANGE	11-34T

WHEELS

FRONT HUB	GULI GL-B43F
REAR HUB	GULI GL-B43R
RIMS	KROSS ALUMINIUM 507X25
TIRES	SCHWALBE SMART SAM 24 x 2,1

COMPONENTS

HANDLEBAR	ALUMINIUM 620 mm 31,8
HANDLEBAR STEM	ALUMINIUM 70 mm/31,8/7°
SEAT POST	ALUMINIUM 27,2 x 300 mm
HEADSET	FP-H813PL 1-1/8"
SADDLE	VELO VL-5061
GRIPS	PROPALM SCALE
PEDALS	FP-917N

GEOMETRY

SIZE	OS
FS - FRAME SIZE*	12
ST - SEAT TUBE LENGTH**	300
TT - TOP TUBE LENGTH**	510
HT - HEAD TUBE LENGTH**	100
SA - SEAT TUBE ANGLE***	73
HA - HEAD TUBE ANGLE***	69
CS - CHAINSTAY LENGTH**	420
WB - WHEELBASE**	990
REACH**	352
STACK**	517
BB DROP**	50

* dimension in inches, ** dimension in mm, *** dimension in degrees

LEVEL JR 4.0



GEAR RATIO 1 x 9

WHEEL DIAMETER 24"

COLOUR VARIANTS



SKU	SIZE	COLOUR	FINISH
KRLVJ424X12M002431	S	silver-blue	gloss

FRAME

FRAME	ALUMINIUM PERFORMANCE
FORK	SR SUNTOUR XCR AIR RLR
FORK TRAVEL	63mm
SIZES	S(12")

DRIVETRAIN

REAR DERAILLEUR	SHIMANO ALIVIO M3100
FRONT BRAKE	SHIMANO MT200
REAR BRAKE	SHIMANO MT200
BRAKE LEVERS	SHIMANO MT200
SHIFTERS	SHIMANO ACERA M3100
CRANKSET	WHEEL TOP
SPROCKETS	32T/152 mm
BOTTOM BRACKET	FP-B902
CHAIN	SHIMANO HG53
CASSETTE/FREEWHEEL	SHIMANO ALTUS HG200
CASSETTE/FREEWHEEL RANGE	11-34T

WHEELS

FRONT HUB	GL-B43F-DS
REAR HUB	GL-B43R-DS
RIMS	KROSS ALUMINIUM 507 x 19
TIRES	SCHWALBE SMART SAM 24 x 2,1

COMPONENTS

HANDLEBAR	ALUMINIUM 620 mm 31.8
HANDLEBAR STEM	ALUMINIUM 70 mm/31,8/7°
SEAT POST	ALUMINIUM 27,2 x 300 mm
HEADSET	FP-H813PL 1-1/8"
SADDLE	VELO VL-5061
GRIPS	KROSS SCALE
PEDALS	FP-917N

GEOMETRY

SIZE	S
FS - FRAME SIZE*	12
ST - SEAT TUBE LENGTH**	300
TT - TOP TUBE LENGTH**	510
HT - HEAD TUBE LENGTH**	100
SA - SEAT TUBE ANGLE***	73
HA - HEAD TUBE ANGLE***	69
CS - CHAINSTAY LENGTH**	420
WB - WHEELBASE**	990
REACH**	352
STACK**	517
BB DROP**	50

* dimension in inches, ** dimension in mm, *** dimension in degrees

LEVEL JR 3.0



GEAR RATIO 1 x 8

WHEEL DIAMETER 24"

COLOUR VARIANTS



SKU	SIZE	COLOUR	FINISH
KRLVJL24X12M002430	S	silver-green	mat

FRAME

FRAME	ALUMINIUM PERFORMANCE
FORK	ALUMINIUM
SIZES	S(12")

DRIVETRAIN

REAR DERAILLEUR	SHIMANO TOURNEY TX800
FRONT BRAKE	SHIMANO MT200
REAR BRAKE	SHIMANO MT200
BRAKE LEVERS	SHIMANO MT200
SHIFTERS	SHIMANO ALTUS M315
CRANKSET	WHEEL TOP
SPROCKETS	32T/152 mm
BOTTOM BRACKET	FP-B902
CHAIN	YBN S8
CASSETTE/FREEWHEEL	SHIMANO ACERA HG41
CASSETTE/FREEWHEEL RANGE	11-34T

WHEELS

FRONT HUB	GL-B43F-DS
REAR HUB	GL-B43R-DS
RIMS	RYDE RIVAL 19 507 x 19
TIRES	SCHWALBE SMART SAM 24 x 2,35

COMPONENTS

HANDLEBAR	ALUMINIUM 580 mm 31.8
HANDLEBAR STEM	ALUMINIUM 70 mm/31,8/7°
SEAT POST	ALUMINIUM 27,2 x 300 mm
HEADSET	FP-H813PL 1-1/8"
SADDLE	SELLE ROYAL EXPLORA JRN
GRIPS	HERRMANS
PEDALS	FP-804

GEOMETRY

SIZE	S
FS - FRAME SIZE*	12
ST - SEAT TUBE LENGTH**	300
TT - TOP TUBE LENGTH**	510
HT - HEAD TUBE LENGTH**	100
SA - SEAT TUBE ANGLE***	73
HA - HEAD TUBE ANGLE***	69
CS - CHAINSTAY LENGTH**	420
WB - WHEELBASE**	990
REACH**	352
STACK**	517
BB DROP**	50

* dimension in inches, ** dimension in mm, *** dimension in degrees

LEVEL JR 2.0



GEAR RATIO 1 x 8

WHEEL DIAMETER 24"

COLOUR VARIANTS



SKU	SIZE	COLOUR	FINISH
KRLVJ224X12M002428	OS	black-red	gloss
KRLVJ224X12M002429	OS	yellow	gloss

FRAME

FRAME	ALUMINIUM PERFORMANCE
FORK	ALUMINIUM
SIZES	OS(12")

DRIVETRAIN

REAR DERAILLEUR	SHIMANO TOURNEY TX800
FRONT BRAKE	V-BRAKE
REAR BRAKE	V-BRAKE
BRAKE LEVERS	ALUMINIUM
SHIFTERS	SHIMANO ALTUS M315
CRANKSET	WHEEL TOP
SPROCKETS	32T/152 mm
BOTTOM BRACKET	FP-B902
CHAIN	YBN S8
CASSETTE/FREEWHEEL	SHIMANO ACERA HG41
CASSETTE/FREEWHEEL RANGE	11-34T

WHEELS

FRONT HUB	GL-B01F-QR
REAR HUB	GL-B42R
RIMS	KROSS ALUMINIUM 507 x 19
TIRES	WANDA P1226 24 x 2,35

COMPONENTS

HANDLEBAR	ALUMINIUM 580 mm 31.8
HANDLEBAR STEM	ALUMINIUM 70 mm/31,8/7°
SEAT POST	STEEL 27,2 x 300
HEADSET	FP-H813PL 1-1/8"
SADDLE	SELLE ROYAL EXPLORA JRN
GRIPS	HERRMANS
PEDALS	FP-804

GEOMETRY

SIZE	OS
FS - FRAME SIZE*	12
ST - SEAT TUBE LENGTH**	300
TT - TOP TUBE LENGTH**	510
HT - HEAD TUBE LENGTH**	100
SA - SEAT TUBE ANGLE***	73
HA - HEAD TUBE ANGLE***	69
CS - CHAINSTAY LENGTH**	420
WB - WHEELBASE**	990
REACH**	352
STACK**	517
BB DROP**	50

* dimension in inches, ** dimension in mm, *** dimension in degrees

LEVEL JR 1.0

NEW



GEAR RATIO 1 x 8

WHEEL DIAMETER 24"

COLOUR VARIANTS



SKU	SIZE	COLOUR	FINISH
KRLVJ124X12M006839	M	red-maritime	gloss
KRLVJ124X12M007424	M	beige	gloss

FRAME

FRAME	ALUMINIUM
FORK	ALUMINIUM
SIZES	M(12")

DRIVETRAIN

REAR DERAILLEUR	SHIMANO TOURNEY TX800
FRONT BRAKE	V-BRAKE
REAR BRAKE	V-BRAKE
BRAKE LEVERS	ALUMINIUM
SHIFTERS	SHIMANO ALTUS M315
CRANKSET	WHEEL TOP SPF5H-MZ
SPROCKETS	32T/152 mm
BOTTOM BRACKET	FP-B902
CHAIN	YBN S8
CASSETTE/FREEWHEEL	SHIMANO ACERA HG41
CASSETTE/FREEWHEEL RANGE	11-34T

WHEELS

FRONT HUB	GULI GL-B01F
REAR HUB	GULI GL-B42R
RIMS	KROSS ALUMINIUM 507 x 19
TIRES	WANDA P1226 24 x 2,35

COMPONENTS

HANDLEBAR	ALUMINIUM 580 mm 31.8
HANDLEBAR STEM	ALUMINIUM 70 mm/31,8/7°
SEAT POST	STEEL 27,2 x 300
HEADSET	FP-H813PL 1-1/8"
SADDLE	SELLE ROYAL EXPLORA JRN
GRIPS	PROPALM SCALE
PEDALS	FP-804

GEOMETRY

SIZE	M
FS - FRAME SIZE*	12
ST - SEAT TUBE LENGTH**	300
TT - TOP TUBE LENGTH**	510
HT - HEAD TUBE LENGTH**	100
SA - SEAT TUBE ANGLE***	73
HA - HEAD TUBE ANGLE***	69
CS - CHAINSTAY LENGTH**	420
WB - WHEELBASE**	990
REACH**	352
STACK**	517
BB DROP**	50

* dimension in inches, ** dimension in mm, *** dimension in degrees

DUST JR 1.0

NEW



GEAR RATIO 1 x 8

WHEEL DIAMETER 24"

COLOUR VARIANTS



SKU	SIZE	COLOUR	FINISH
KRDUJ124X12M003551	OS	navy blue-lime	mat
KRDUJ124X12M006574	OS	gray	gloss

FRAME

FRAME	ALUMINIUM PERFORMANCE
FORK	KROSS
FORK TRAVEL	50 mm
SIZES	OS(12")

DRIVETRAIN

REAR DERAILLEUR	SHIMANO TOURNEY TX800
FRONT BRAKE	V-BRAKE
REAR BRAKE	V-BRAKE
BRAKE LEVERS	ALUMINIUM
SHIFTERS	SHIMANO ALTUS M315
CRANKSET	WHEEL TOP
SPROCKETS	32T/152 mm
BOTTOM BRACKET	FP-B902
CHAIN	YBN S7
CASSETTE/FREEWHEEL	SUNRUN FW-8I
CASSETTE/FREEWHEEL RANGE	13-28T

WHEELS

FRONT HUB	GL-B01F-QR
REAR HUB	GL-B01R-QR
RIMS	KROSS ALUMINIUM 507 x 19
TIRES	WANDA P1255 24 x 1,95

COMPONENTS

HANDLEBAR	ALUMINIUM 580 mm 31.8
HANDLEBAR STEM	ALUMINIUM 60 mm/31,8/7°
SEAT POST	STEEL 27,2 x 300
HEADSET	FP-H801S 1-1/8"
SADDLE	SELLE ROYAL EXPLORA JRN
GRIPS	HERRMANS
PEDALS	FP-804

GEOMETRY

SIZE	OS
FS - FRAME SIZE*	12
ST - SEAT TUBE LENGTH**	310
TT - TOP TUBE LENGTH**	471
HT - HEAD TUBE LENGTH**	110
SA - SEAT TUBE ANGLE***	72
HA - HEAD TUBE ANGLE***	69
CS - CHAINSTAY LENGTH**	405
WB - WHEELBASE**	938
REACH**	306
STACK**	505
BB DROP**	25

* dimension in inches, ** dimension in mm, *** dimension in degrees

HEXAGON JR 1.0



GEAR RATIO 1 x 8

WHEEL DIAMETER 24"

COLOUR VARIANTS



SKU	SIZE	COLOUR	FINISH
KRHEJ124X12U006974	OS	maritime	gloss
KRHEJ124X12U006975	OS	navy	gloss

FRAME

FRAME	ALUMINIUM
FORK	KROSS
FORK TRAVEL	40 mm
SIZES	OS(12")

DRIVETRAIN

REAR DERAILLEUR	SHIMANO TOURNEY TX800
FRONT BRAKE	V-BRAKE
REAR BRAKE	V-BRAKE
BRAKE LEVERS	ALUMINIUM
SHIFTERS	SHIMANO ALTUS M315
CRANKSET	WHEEL TOP SPF5H-MZ
SPROCKETS	32T/152 mm
BOTTOM BRACKET	FP-B902
CHAIN	YBN S7
CASSETTE/FREEWHEEL	SUNRUN FW-8I
CASSETTE/FREEWHEEL RANGE	13-28T

WHEELS

FRONT HUB	GULI GL-B01F
REAR HUB	GULI GL-B01R
RIMS	KROSS ALUMINIUM 507 x 19
TIRES	WANDA P1255 24 x 1,95

COMPONENTS

HANDLEBAR	STEEL 560 mm 25.4
HANDLEBAR STEM	ALUMINIUM 75 mm/25,4/15°
SEAT POST	STEEL 27,2 x 300
HEADSET	FP-H801S 1-1/8"
SADDLE	SELLE ROYAL EXPLORA JRN
GRIPS	HERMANS 89B
PEDALS	FP-804

GEOMETRY

SIZE	OS
FS - FRAME SIZE*	12
ST - SEAT TUBE LENGTH**	310
TT - TOP TUBE LENGTH**	520
HT - HEAD TUBE LENGTH**	120
SA - SEAT TUBE ANGLE***	72
HA - HEAD TUBE ANGLE***	70
CS - CHAINSTAY LENGTH**	406
WB - WHEELBASE**	977
REACH**	351
STACK**	519
BB DROP**	25

* dimension in inches, ** dimension in mm, *** dimension in degrees

HEXAGON JR 1.0



GEAR RATIO 1 x 8

WHEEL DIAMETER 24"

COLOUR VARIANTS



SKU	SIZE	COLOUR	FINISH
KRHEJ124X12M003552	OS	red-white-black	gloss
KRHEJ124X12M003553	OS	black-silver-yellow	gloss

FRAME

FRAME	ALUMINIUM PERFORMANCE
FORK	KROSS
FORK TRAVEL	40 mm
SIZES	OS(12")

DRIVETRAIN

REAR DERAILLEUR	SHIMANO TOURNEY TX800
FRONT BRAKE	V-BRAKE
REAR BRAKE	V-BRAKE
BRAKE LEVERS	ALUMINIUM
SHIFTERS	SHIMANO ALTUS M315
CRANKSET	WHEEL TOP
SPROCKETS	32T/152 mm
BOTTOM BRACKET	FP-B902
CHAIN	YBN S7
CASSETTE/FREEWHEEL	SUNRUN FW-8I
CASSETTE/FREEWHEEL RANGE	13-28T

WHEELS

FRONT HUB	GL-B01F-QR
REAR HUB	GL-B01R-QR
RIMS	KROSS ALUMINIUM 507 x 19
TIRES	WANDA P1255 24 x 1,95

COMPONENTS

HANDLEBAR	STEEL 560 mm 25.4
HANDLEBAR STEM	ALUMINIUM 75 mm/25,4/15°
SEAT POST	STEEL 27,2 x 300
HEADSET	FP-H801S 1-1/8"
SADDLE	SELLE ROYAL EXPLORA JRN
GRIPS	HERRMANS
PEDALS	FP-804

GEOMETRY

SIZE	OS
FS - FRAME SIZE*	12
ST - SEAT TUBE LENGTH**	310
TT - TOP TUBE LENGTH**	520
HT - HEAD TUBE LENGTH**	120
SA - SEAT TUBE ANGLE***	72
HA - HEAD TUBE ANGLE***	70
CS - CHAINSTAY LENGTH**	406
WB - WHEELBASE**	977
REACH**	351
STACK**	519
BB DROP**	25

* dimension in inches, ** dimension in mm, *** dimension in degrees

LEA JR 3.0



GEAR RATIO 1 x 8

WHEEL DIAMETER 24"

COLOUR VARIANTS



SKU	SIZE	COLOUR	FINISH
KRLEJL24X12W002650	DOS	silver-pink	gloss

FRAME

FRAME	ALUMINIUM PERFORMANCE
FORK	ALUMINIUM
SIZES	DOS(12")

DRIVETRAIN

REAR DERAILLEUR	SHIMANO TOURNEY TX800
FRONT BRAKE	SHIMANO MT200
REAR BRAKE	SHIMANO MT200
BRAKE LEVERS	SHIMANO MT200
SHIFTERS	SHIMANO ALTUS M315
CRANKSET	WHEEL TOP
SPROCKETS	32T/152 mm
BOTTOM BRACKET	FP-B902
CHAIN	YBN S8
CASSETTE/FREEWHEEL	SHIMANO ACERA HG41
CASSETTE/FREEWHEEL RANGE	11-34T

WHEELS

FRONT HUB	GL-B43F-DS
REAR HUB	GL-B43R-DS
RIMS	RYDE RIVAL 19 507 x 19
TIRES	SCHWALBE SMART SAM 24 x 2,35

COMPONENTS

HANDLEBAR	ALUMINIUM 580 mm 31.8
HANDLEBAR STEM	ALUMINIUM 70 mm/31,8/17°
SEAT POST	ALUMINIUM 27,2 x 300 mm
HEADSET	FP-H813PL 1-1/8"
SADDLE	SELLE ROYAL EXPLORA JRN
GRIPS	HERRMANS
PEDALS	FP-804

GEOMETRY

SIZE	DOS
FS - FRAME SIZE*	12
ST - SEAT TUBE LENGTH**	300
TT - TOP TUBE LENGTH**	510
HT - HEAD TUBE LENGTH**	100
SA - SEAT TUBE ANGLE***	73
HA - HEAD TUBE ANGLE***	69
CS - CHAINSTAY LENGTH**	420
WB - WHEELBASE**	990
REACH**	352
STACK**	517
BB DROP**	50

* dimension in inches, ** dimension in mm, *** dimension in degrees

LEA JR 2.0



GEAR RATIO 1 x 8

WHEEL DIAMETER 24"

COLOUR VARIANTS



SKU	SIZE	COLOUR	FINISH
KRLEJ224X12W006989	DOS	purple	gloss
KRLEJ224X12W007423	DOS	pink	gloss

FRAME

FRAME	ALUMINIUM
FORK	ALUMINIUM
SIZES	DOS(12")

DRIVETRAIN

REAR DERAILLEUR	SHIMANO TOURNEY TX800
FRONT BRAKE	SHIMANO MT200
REAR BRAKE	SHIMANO MT200
BRAKE LEVERS	SHIMANO MT200
BRAKE DISCS	POWER RT600 160 6B
SHIFTERS	SHIMANO ALTUS M315
CRANKSET	WHEEL TOP SPF5H-MZ
SPROCKETS	32T/152 mm
BOTTOM BRACKET	FP-B902
CHAIN	YBN S8
CASSETTE/FREEWHEEL	SHIMANO ACERA HG41
CASSETTE/FREEWHEEL RANGE	11-34T

WHEELS

FRONT HUB	GULI GL-B43F
REAR HUB	GULI GL-B43R
RIMS	RYDE RIVAL 19 507 x 19
TIRES	SCHWALBE SMART SAM 24 x 2,35

COMPONENTS

HANDLEBAR	ALUMINIUM 580 mm 31.8
HANDLEBAR STEM	ALUMINIUM 70 mm/31,8/17°
SEAT POST	ALUMINIUM 27,2 x 300 mm
HEADSET	FP-H813PL 1-1/8"
SADDLE	SELLE ROYAL EXPLORA JRN
GRIPS	PROPALM SCALE
PEDALS	FP-804

GEOMETRY

SIZE	DOS
FS - FRAME SIZE*	12
ST - SEAT TUBE LENGTH**	300
TT - TOP TUBE LENGTH**	510
HT - HEAD TUBE LENGTH**	100
SA - SEAT TUBE ANGLE***	73
HA - HEAD TUBE ANGLE***	69
CS - CHAINSTAY LENGTH**	420
WB - WHEELBASE**	990
REACH**	352
STACK**	517
BB DROP**	50

* dimension in inches, ** dimension in mm, *** dimension in degrees

LEA JR 2.0



GEAR RATIO 1 x 8

WHEEL DIAMETER 24"

COLOUR VARIANTS



SKU	SIZE	COLOUR	FINISH
KRLEJ224X12W002303	DOS	purple-blue	mat
KRLEJ224X12W002304	DOS	grey-turquoise	gloss

FRAME

FRAME	ALUMINIUM PERFORMANCE
FORK	ALUMINIUM
SIZES	DOS(12")

DRIVETRAIN

REAR DERAILLEUR	SHIMANO TOURNEY TX800
FRONT BRAKE	V-BRAKE
REAR BRAKE	V-BRAKE
BRAKE LEVERS	ALUMINIUM
SHIFTERS	SHIMANO ALTUS M315
CRANKSET	WHEEL TOP
SPROCKETS	32T/152 mm
BOTTOM BRACKET	FP-B902
CHAIN	YBN S8
CASSETTE/FREEWHEEL	SHIMANO ACERA HG41
CASSETTE/FREEWHEEL RANGE	11-34T

WHEELS

FRONT HUB	GL-B01F-QR
REAR HUB	GL-B42R
RIMS	KROSS ALUMINIUM 507 x 19
TIRES	WANDA P1226 24 x 2,35

COMPONENTS

HANDLEBAR	ALUMINIUM 580 mm 31.8
HANDLEBAR STEM	ALUMINIUM 70 mm/31,8/17°
SEAT POST	STEEL 27,2 x 300
HEADSET	FP-H813PL 1-1/8"
SADDLE	SELLE ROYAL EXPLORA JRN
GRIPS	HERRMANS
PEDALS	FP-804

GEOMETRY

SIZE	DOS
FS - FRAME SIZE*	12
ST - SEAT TUBE LENGTH**	300
TT - TOP TUBE LENGTH**	510
HT - HEAD TUBE LENGTH**	100
SA - SEAT TUBE ANGLE***	73
HA - HEAD TUBE ANGLE***	69
CS - CHAINSTAY LENGTH**	420
WB - WHEELBASE**	990
REACH**	352
STACK**	517
BB DROP**	50

* dimension in inches, ** dimension in mm, *** dimension in degrees

LEA JR 1.0



GEAR RATIO 1 x 8

WHEEL DIAMETER 24"

COLOUR VARIANTS



SKU	SIZE	COLOUR	FINISH
KRLEJ124X12W006988	DOS	grey-green	gloss
KRLEJ124X12W007422	DOS	burgundy-pink	gloss

FRAME

FRAME	ALUMINIUM
FORK	ALUMINIUM
SIZES	DOS(12")

DRIVETRAIN

REAR DERAILLEUR	SHIMANO TOURNEY TX800
FRONT BRAKE	V-BRAKE
REAR BRAKE	V-BRAKE
BRAKE LEVERS	ALUMINIUM
SHIFTERS	SHIMANO ALTUS M315
CRANKSET	WHEEL TOP SPF5H-MZ
SPROCKETS	32T/152 mm
BOTTOM BRACKET	FP-B902
CHAIN	YBN S8
CASSETTE/FREEWHEEL	SHIMANO ACERA HG41
CASSETTE/FREEWHEEL RANGE	11-34T

WHEELS

FRONT HUB	GULI GL-B01F
REAR HUB	GULI GL-B42R
RIMS	KROSS ALUMINIUM 507 x 19
TIRES	WANDA P1226 24 x 2,35

COMPONENTS

HANDLEBAR	ALUMINIUM 580 mm 31.8
HANDLEBAR STEM	ALUMINIUM 70 mm/31,8/17°
SEAT POST	STEEL 27,2 x 300
HEADSET	FP-H813PL 1-1/8"
SADDLE	SELLE ROYAL EXPLORA JRN
GRIPS	PROPALM SCALE
PEDALS	FP-804

GEOMETRY

SIZE	DOS
FS - FRAME SIZE*	12
ST - SEAT TUBE LENGTH**	300
TT - TOP TUBE LENGTH**	510
HT - HEAD TUBE LENGTH**	100
SA - SEAT TUBE ANGLE***	73
HA - HEAD TUBE ANGLE***	69
CS - CHAINSTAY LENGTH**	420
WB - WHEELBASE**	990
REACH**	352
STACK**	517
BB DROP**	50

* dimension in inches, ** dimension in mm, *** dimension in degrees

LEA JR 1.0



GEAR RATIO 1 x 8

WHEEL DIAMETER 24"

COLOUR VARIANTS



SKU	SIZE	COLOUR	FINISH
KRLEJ124X12W003554	DS	celadon-green-mint	gloss
KRLEJ124X12W003555	DS	black-grey-pink	gloss

FRAME

FRAME	ALUMINIUM PERFORMANCE
FORK	KROSS
FORK TRAVEL	40 mm
SIZES	DS(12")

DRIVETRAIN

REAR DERAILLEUR	SHIMANO TOURNEY TX800
FRONT BRAKE	V-BRAKE
REAR BRAKE	V-BRAKE
BRAKE LEVERS	ALUMINIUM
SHIFTERS	SHIMANO ALTUS M315
CRANKSET	WHEEL TOP
SPROCKETS	32T/152 mm
BOTTOM BRACKET	FP-B902
CHAIN	YBN S7
CASSETTE/FREEWHEEL	SUNRUN FW-8I
CASSETTE/FREEWHEEL RANGE	13-28T

WHEELS

FRONT HUB	GL-B01F-QR
REAR HUB	GL-B01R-QR
RIMS	KROSS ALUMINIUM 507 x 19
TIRES	WANDA P1255 24 x 1,95

COMPONENTS

HANDLEBAR	STEEL 560 mm 25.4
HANDLEBAR STEM	ALUMINIUM 75 mm/25,4/15°
SEAT POST	STEEL 27,2 x 300
HEADSET	FP-H801S 1-1/8"
SADDLE	SELLE ROYAL EXPLORA JRN
GRIPS	HERRMANS
PEDALS	FP-804

GEOMETRY

SIZE	DS
FS - FRAME SIZE*	12
ST - SEAT TUBE LENGTH**	310
TT - TOP TUBE LENGTH**	520
HT - HEAD TUBE LENGTH**	120
SA - SEAT TUBE ANGLE***	72
HA - HEAD TUBE ANGLE***	70
CS - CHAINSTAY LENGTH**	406
WB - WHEELBASE**	977
REACH**	351
STACK**	519
BB DROP**	25

* dimension in inches, ** dimension in mm, *** dimension in degrees

LEVEL MINI 3.0 LIGHT



GEAR RATIO 1 x 6

WHEEL DIAMETER 20"

COLOUR VARIANTS



SKU	SIZE	COLOUR	FINISH
KRLVM320X11M001892	OS	navy blue-blue	gloss

FRAME

FRAME	ALUMINIUM PERFORMANCE
FORK	ALUMINIUM
SIZES	OS(11")

DRIVETRAIN

REAR DERAILLEUR	SHIMANO TY21
FRONT BRAKE	V-BRAKE
REAR BRAKE	V-BRAKE
BRAKE LEVERS	ALUMINIUM
SHIFTERS	SHIMANO TX30
CRANKSET	WHEEL TOP
SPROCKETS	32T/127 mm
BOTTOM BRACKET	FP-B902
CHAIN	YBN S20
CASSETTE/FREEWHEEL	SHIMANO TOURNEY MF-TZ500
CASSETTE/FREEWHEEL RANGE	14-28T

WHEELS

FRONT HUB	GL-B01F
REAR HUB	GL-B01R
RIMS	KROSS ALUMINIUM 406 x 19
TIRES	WANDA P103 20 x 1,95

COMPONENTS

HANDLEBAR	ALUMINIUM 540 mm 25.4
HANDLEBAR STEM	ALUMINIUM 60 mm/25,4/15°
SEAT POST	ALUMINIUM 27,2 x 250 mm
HEADSET	FP-H801S 1-1/8"
SADDLE	SELLE ROYAL EXPLORA JRN
GRIPS	HERRMANS
PEDALS	FP-628

GEOMETRY

SIZE	OS
FS - FRAME SIZE*	11
ST - SEAT TUBE LENGTH**	273
TT - TOP TUBE LENGTH**	440
HT - HEAD TUBE LENGTH**	125
SA - SEAT TUBE ANGLE***	72
HA - HEAD TUBE ANGLE***	70
CS - CHAINSTAY LENGTH**	350
WB - WHEELBASE**	851
REACH**	309
STACK**	404
BB DROP**	-10 (ascent)

* dimension in inches, ** dimension in mm, *** dimension in degrees

LEVEL MINI 2.0



GEAR RATIO 1 x 6

WHEEL DIAMETER 20"

COLOUR VARIANTS



SKU	SIZE	COLOUR	FINISH
KRLVM220X11M003564	DOS	red-black-white	gloss
KRLVM220X11M003565	DOS	yellow-black	gloss

FRAME

FRAME	ALUMINIUM PERFORMANCE
FORK	KROSS
FORK TRAVEL	40 mm
SIZES	OS(12")

DRIVETRAIN

REAR DERAILLEUR	SHIMANO TY21
FRONT BRAKE	V-BRAKE
REAR BRAKE	V-BRAKE
BRAKE LEVERS	ALUMINIUM
SHIFTERS	SHIMANO TX30
CRANKSET	WHEEL TOP
SPROCKETS	32T/127 mm
BOTTOM BRACKET	FP-B902
CHAIN	YBN S20
CASSETTE/FREEWHEEL	SHIMANO TOURNEY MF-TZ500
CASSETTE/FREEWHEEL RANGE	14-28T

WHEELS

FRONT HUB	GL-B01F
REAR HUB	GL-B01R
RIMS	KROSS ALUMINIUM 406 x 19
TIRES	WANDA P103 20 x 1,95

COMPONENTS

HANDLEBAR	STEEL 540 mm 25.4
HANDLEBAR STEM	STEEL 60 mm/25,4/10°
SEAT POST	STEEL 27,2 x 250
HEADSET	FP-H803 1-1/8"
SADDLE	SELLE ROYAL EXPLORA JRN
GRIPS	HERRMANS
PEDALS	FP-628

GEOMETRY

SIZE	DOS
FS - FRAME SIZE*	11
ST - SEAT TUBE LENGTH**	273
TT - TOP TUBE LENGTH**	440
HT - HEAD TUBE LENGTH**	120
SA - SEAT TUBE ANGLE***	72
HA - HEAD TUBE ANGLE***	70
CS - CHAINSTAY LENGTH**	350
WB - WHEELBASE**	851
REACH**	301
STACK**	428
BB DROP**	10

* dimension in inches, ** dimension in mm, *** dimension in degrees

HEXAGON MINI 1.0



SKU	SIZE	COLOUR	FINISH
KRHEM120X11M003558	OS	red-white-orange	gloss
KRHEM120X11M003559	OS	navy blue-white-orange	gloss
KRHEM120X11M003918	OS	graphite-lime-silver	gloss

GEAR RATIO 1 x 6

WHEEL DIAMETER 20"

COLOUR VARIANTS



FRAME

FRAME	ALUMINIUM PERFORMANCE
FORK	STAL
SIZES	OS(11")

DRIVETRAIN

REAR DERAILLEUR	SHIMANO TY21
FRONT BRAKE	V-BRAKE
REAR BRAKE	V-BRAKE
BRAKE LEVERS	ALUMINIUM
SHIFTERS	SHIMANO TX30
CRANKSET	WHEEL TOP
SPROCKETS	32T/127 mm
BOTTOM BRACKET	FP-B902
CHAIN	YBN S20
CASSETTE/FREEWHEEL	SHIMANO TOURNEY MF-TZ500
CASSETTE/FREEWHEEL RANGE	14-28T

WHEELS

FRONT HUB	GL-B01F
REAR HUB	GL-B01R
RIMS	KROSS ALUMINIUM 406 x 19
TIRES	WANDA P103 20 x 1,95

COMPONENTS

HANDLEBAR	STEEL 540 mm 25.4
HANDLEBAR STEM	STEEL 60 mm/25,4/10°
SEAT POST	STEEL 27,2 x 250
HEADSET	FP-H803 1-1/8"
SADDLE	SELLE ROYAL EXPLORA JRN
GRIPS	HERRMANS
PEDALS	FP-628

GEOMETRY

SIZE	OS
FS - FRAME SIZE*	11
ST - SEAT TUBE LENGTH**	273
TT - TOP TUBE LENGTH**	440
HT - HEAD TUBE LENGTH**	140
SA - SEAT TUBE ANGLE***	72
HA - HEAD TUBE ANGLE***	70
CS - CHAINSTAY LENGTH**	350
WB - WHEELBASE**	851
REACH**	301
STACK**	428
BB DROP**	-10 (ascent)

* dimension in inches, ** dimension in mm, *** dimension in degrees

LEA MINI 3.0 LIGHT



GEAR RATIO 1 x 6

WHEEL DIAMETER 20"

COLOUR VARIANTS



SKU	SIZE	COLOUR	FINISH
KRLEM320X11W001893	DOS	white-pink-purple	gloss

FRAME

FRAME	ALUMINIUM PERFORMANCE
FORK	ALUMINIUM
SIZES	OS(11")

DRIVETRAIN

REAR DERAILLEUR	SHIMANO TY21
FRONT BRAKE	V-BRAKE
REAR BRAKE	V-BRAKE
BRAKE LEVERS	ALUMINIUM
SHIFTERS	SHIMANO TX30
CRANKSET	WHEEL TOP
SPROCKETS	32T/127 mm
BOTTOM BRACKET	FP-B902
CHAIN	YBN S20
CASSETTE/FREEWHEEL	SHIMANO TOURNEY MF-TZ500
CASSETTE/FREEWHEEL RANGE	14-28T

WHEELS

FRONT HUB	GL-B01F
REAR HUB	GL-B01R
RIMS	KROSS ALUMINIUM 406 x 19
TIRES	WANDA P103 20 x 1,95

COMPONENTS

HANDLEBAR	ALUMINIUM 540 mm 25,4
HANDLEBAR STEM	ALUMINIUM 60 mm/25,4/15°
SEAT POST	ALUMINIUM 27,2 x 250 mm
HEADSET	FP-H801S 1-1/8"
SADDLE	SELLE ROYAL EXPLORA JRN
GRIPS	HERRMANS
PEDALS	FP-628

GEOMETRY

SIZE	DOS
FS - FRAME SIZE*	11
ST - SEAT TUBE LENGTH**	273
TT - TOP TUBE LENGTH**	440
HT - HEAD TUBE LENGTH**	125
SA - SEAT TUBE ANGLE***	72
HA - HEAD TUBE ANGLE***	70
CS - CHAINSTAY LENGTH**	350
WB - WHEELBASE**	851
REACH**	309
STACK**	404
BB DROP**	-10 (ascant)

* dimension in inches, ** dimension in mm, *** dimension in degrees

LEA MINI 2.0



GEAR RATIO 1 x 6

WHEEL DIAMETER 20"

COLOUR VARIANTS



SKU	SIZE	COLOUR	FINISH
KRLEM220X11W003562	DOS	celadon-lime	gloss
KRLEM220X11W003563	DOS	white-red-pink	gloss

FRAME

FRAME	ALUMINIUM PERFORMANCE
FORK	KROSS
FORK TRAVEL	40 mm
SIZES	DOS(11")

DRIVETRAIN

REAR DERAILLEUR	SHIMANO TY21
FRONT BRAKE	V-BRAKE
REAR BRAKE	V-BRAKE
BRAKE LEVERS	ALUMINIUM
SHIFTERS	SHIMANO TX30
CRANKSET	WHEEL TOP
SPROCKETS	32T/127 mm
BOTTOM BRACKET	FP-B902
CHAIN	YBN S20
CASSETTE/FREEWHEEL	SHIMANO TOURNEY MF-TZ500
CASSETTE/FREEWHEEL RANGE	14-28T

WHEELS

FRONT HUB	GL-B01F
REAR HUB	GL-B01R
RIMS	KROSS ALUMINIUM 406 x 19
TIRES	WANDA P103 20 x 1,95

COMPONENTS

HANDLEBAR	STEEL 540 mm 25.4
HANDLEBAR STEM	STEEL 60 mm/25,4/10°
SEAT POST	STEEL 27,2 x 250
HEADSET	FP-H803 1-1/8"
SADDLE	SELLE ROYAL EXPLORA JRN
GRIPS	HERRMANS
PEDALS	FP-628

GEOMETRY

SIZE	DOS
FS - FRAME SIZE*	11
ST - SEAT TUBE LENGTH**	273
TT - TOP TUBE LENGTH**	440
HT - HEAD TUBE LENGTH**	120
SA - SEAT TUBE ANGLE***	72
HA - HEAD TUBE ANGLE***	70
CS - CHAINSTAY LENGTH**	350
WB - WHEELBASE**	851
REACH**	301
STACK**	428
BB DROP**	10

* dimension in inches, ** dimension in mm, *** dimension in degrees

LEA MINI 1.0



GEAR RATIO 1 x 6

WHEEL DIAMETER 20"

COLOUR VARIANTS



SKU	SIZE	COLOUR	FINISH
KRLEM120X11W003560	DOS	grey-celadon	gloss
KRLEM120X11W003561	DOS	white-blue-pink	gloss

FRAME

FRAME	ALUMINIUM PERFORMANCE
FORK	STAL
SIZES	DOS(11")

DRIVETRAIN

REAR DERAILLEUR	SHIMANO TY21
FRONT BRAKE	V-BRAKE
REAR BRAKE	V-BRAKE
BRAKE LEVERS	ALUMINIUM
SHIFTERS	SHIMANO TX30
CRANKSET	WHEEL TOP
SPROCKETS	32T/127 mm
BOTTOM BRACKET	FP-B902
CHAIN	YBN S20
CASSETTE/FREEWHEEL	SHIMANO TOURNEY MF-TZ500
CASSETTE/FREEWHEEL RANGE	14-28T

WHEELS

FRONT HUB	GL-B01F
REAR HUB	GL-B01R
RIMS	KROSS ALUMINIUM 406 x 19
TIRES	WANDA P103 20 x 1,95

COMPONENTS

HANDLEBAR	STEEL 540 mm 25.4
HANDLEBAR STEM	STEEL 60 mm/25,4/10°
SEAT POST	STEEL 27,2 x 250
HEADSET	FP-H803 1-1/8"
SADDLE	SELLE ROYAL EXPLORA JRN
GRIPS	HERRMANS
PEDALS	FP-619

GEOMETRY

SIZE	DOS
FS - FRAME SIZE*	11
ST - SEAT TUBE LENGTH**	273
TT - TOP TUBE LENGTH**	440
HT - HEAD TUBE LENGTH**	120
SA - SEAT TUBE ANGLE***	72
HA - HEAD TUBE ANGLE***	70
CS - CHAINSTAY LENGTH**	350
WB - WHEELBASE**	850
REACH**	309
STACK**	400
BB DROP**	10

* dimension in inches, ** dimension in mm, *** dimension in degrees

MINI 4.0



GEAR RATIO 1
WHEEL DIAMETER 16"
COLOUR VARIANTS



SKU	SIZE	COLOUR	FINISH
KRMN4Z16X10W004261	DOS	celadon-blue-lime	gloss
KRMN4Z16X10W005102	DOS	pink-celadon-pink	gloss

FRAME

FRAME	ALUMINIUM
FORK	STAL
SIZES	DOS(9")

DRIVETRAIN

FRONT BRAKE	V-BRAKE
REAR BRAKE	V-BRAKE
BRAKE LEVERS	ALUMINIUM
CRANKSET	STAL
SPROCKETS	32T/102 mm
BOTTOM BRACKET	STAL
CHAIN	KMC HV410

WHEELS

FRONT HUB	STAL
REAR HUB	STAL
RIMS	P-6NBK 305 x 20
TIRES	WANDA P1023 16 x 1,95

COMPONENTS

HANDLEBAR	STEEL 460 mm 25.4
HANDLEBAR STEM	STEEL 60 mm/25,4/25°
SEAT POST	STEEL 27,2 x 230
HEADSET	STAL
SADDLE	SELLE ROYAL EXPLORA JRN
GRIPS	PCV
PEDALS	FP-619

GEOMETRY

SIZE	DOS
FS - FRAME SIZE*	9
ST - SEAT TUBE LENGTH**	220
TT - TOP TUBE LENGTH**	365
HT - HEAD TUBE LENGTH**	110
SA - SEAT TUBE ANGLE***	74
HA - HEAD TUBE ANGLE***	70
CS - CHAINSTAY LENGTH**	315
WB - WHEELBASE**	724
REACH**	253
STACK**	345
BB DROP**	10

* dimension in inches, ** dimension in mm, *** dimension in degrees

MINI 3.0



GEAR RATIO 1
WHEEL DIAMETER 16"
COLOUR VARIANTS



SKU	SIZE	COLOUR	FINISH
KRMN3Z16X10W004260	DOS	pink-purple-turquoise	gloss
KRMN3Z16X10W005101	DOS	white-celadon-koralowy	gloss

FRAME

FRAME	STAL
FORK	STAL
SIZES	DOS(9")

DRIVETRAIN

FRONT BRAKE	V-BRAKE
REAR BRAKE	V-BRAKE
BRAKE LEVERS	ALUMINIUM
CRANKSET	STAL
SPROCKETS	32T/102 mm
BOTTOM BRACKET	STAL
CHAIN	KMC HV410

WHEELS

FRONT HUB	STAL
REAR HUB	STAL
RIMS	P-6NBK 305 x 20
TIRES	WANDA P1023 16 x 1,95

COMPONENTS

HANDLEBAR	STEEL 460 mm 25.4
HANDLEBAR STEM	STEEL 60 mm/25,4/25°
SEAT POST	STEEL 25,4 x 230
HEADSET	STAL
SADDLE	SELLE ROYAL EXPLORA JRN
GRIPS	PCV
PEDALS	FP-619

GEOMETRY

SIZE	DOS
FS - FRAME SIZE*	9
ST - SEAT TUBE LENGTH**	220
TT - TOP TUBE LENGTH**	365
HT - HEAD TUBE LENGTH**	110
SA - SEAT TUBE ANGLE***	74
HA - HEAD TUBE ANGLE***	70
CS - CHAINSTAY LENGTH**	315
WB - WHEELBASE**	724
REACH**	253
STACK**	345
BB DROP**	10

* dimension in inches, ** dimension in mm, *** dimension in degrees

RACER 4.0



GEAR RATIO 1
WHEEL DIAMETER 16"
COLOUR VARIANTS



SKU	SIZE	COLOUR	FINISH
KRRA4Z16X10M005104	MOS	silver-white-orange	gloss

FRAME

FRAME	ALUMINIUM
FORK	STAL
SIZES	MOS(9")

DRIVETRAIN

FRONT BRAKE	V-BRAKE
REAR BRAKE	V-BRAKE
BRAKE LEVERS	ALUMINIUM
CRANKSET	STAL
SPROCKETS	32T/102 mm
BOTTOM BRACKET	STAL
CHAIN	KMC HV410

WHEELS

FRONT HUB	STAL
REAR HUB	STAL
RIMS	P-6NBK 305 x 20
TIRES	WANDA P1023 16 x 1,95

COMPONENTS

HANDLEBAR	STEEL 460 mm 25.4
HANDLEBAR STEM	STEEL 60 mm/25,4/25°
SEAT POST	STEEL 27,2 x 230
HEADSET	STAL
SADDLE	SELLE ROYAL EXPLORA JRN
GRIPS	PCV
PEDALS	FP-628

GEOMETRY

SIZE	MOS
FS - FRAME SIZE*	9
ST - SEAT TUBE LENGTH**	220
TT - TOP TUBE LENGTH**	365
HT - HEAD TUBE LENGTH**	110
SA - SEAT TUBE ANGLE***	74
HA - HEAD TUBE ANGLE***	70
CS - CHAINSTAY LENGTH**	315
WB - WHEELBASE**	724
REACH**	253
STACK**	345
BB DROP**	10

* dimension in inches, ** dimension in mm, *** dimension in degrees

RACER 3.0



GEAR RATIO 1
WHEEL DIAMETER 16"
COLOUR VARIANTS



SKU	SIZE	COLOUR	FINISH
KRRA3Z16X10M004262	MOS	black-green-blue	gloss
KRRA3Z16X10M005103	MOS	red-orange-white	gloss

FRAME

FRAME	STAL
FORK	STAL
SIZES	MOS(9")

DRIVETRAIN

FRONT BRAKE	V-BRAKE
REAR BRAKE	V-BRAKE
BRAKE LEVERS	ALUMINIUM
CRANKSET	STAL
SPROCKETS	32T/102 mm
BOTTOM BRACKET	STAL
CHAIN	KMC HV410

WHEELS

FRONT HUB	STAL
REAR HUB	STAL
RIMS	P-6NBK 305 x 20
TIRES	WANDA P1023 16 x 1,95

COMPONENTS

HANDLEBAR	STEEL 460 mm 25.4
HANDLEBAR STEM	STEEL 60 mm/25,4/25°
SEAT POST	STEEL 25,4 x 230
HEADSET	STAL
SADDLE	SELLE ROYAL EXPLORA JRN
GRIPS	PCV
PEDALS	FP-628

GEOMETRY

SIZE	MOS
FS - FRAME SIZE*	9
ST - SEAT TUBE LENGTH**	220
TT - TOP TUBE LENGTH**	365
HT - HEAD TUBE LENGTH**	110
SA - SEAT TUBE ANGLE***	74
HA - HEAD TUBE ANGLE***	70
CS - CHAINSTAY LENGTH**	315
WB - WHEELBASE**	724
REACH**	253
STACK**	345
BB DROP**	10

* dimension in inches, ** dimension in mm, *** dimension in degrees





APPAREL

HELMETS | HEADWEAR | EYEWEAR | GLOVES | JACKETS
FLEECES & HOODIES | JERSEYS & SHIRTS
SHORTS | UNDERWEAR | SOCKS | SHOES

APPAREL

HELMETS





NEW

ARBARO HT

The ARBARO helmet is an ideal choice for gravel riders. The design of the helmet fits in with the top models of the KROSS ESKER bikes. Ideal ventilation is provided by 19 vents, while the InMold technology ensures comfort and lightness. An adjustable dial guarantees a great fit and comfort.



SIZES	M (54-58 cm), L (58-61 cm)
WEIGHT	266 g (M), 299 g (L)
VENTILATION OPENINGS	19
ADDITIONAL INFORMATION	InMold, easy adjustment, efficient ventilation system

T4CKS000095LBE	L	white / beige
T4CKS000095LBK	L	black / blue
T4CKS000095MBE	M	white / beige
T4CKS000095MBK	M	black / blue



ROAD PRO

ROAD PRO is a helmet for demanding cyclists. It is very lightweight and ensures a high level of safety thanks to the use of the Double Inmold technology. The comfort and appropriate ventilation of the head during intense training sessions or long rides is guaranteed by the 20 ventilation openings.



SIZES	M (54-58 cm), L (58-62 cm)
WEIGHT	220 g (M), 240 g (L)
VENTILATION OPENINGS	20
ADDITIONAL INFORMATION	Double Inmold, easy to adjust

T4CKS000090MBK	M	black
T4CKS000090LBK	L	black
4CKS000090MWH	M	white
T4CKS000090LWH	L	white



NEW

TERO HT

The TERO helmet is designed for gravel enthusiasts. The InMold technology and 18 vents work very well for both short trips and longer bikepacking routes. The front vents feature mesh to prevent insects from getting under the helmet. An adjustable dial guarantees a great fit and comfort.



SIZES	M (54-58 cm), L (58-61 cm)
WEIGHT	280 g (M), 310 g (L)
VENTILATION OPENINGS	18
ADDITIONAL INFORMATION	InMold, visor included, insect mesh, easy adjustment

T4CKS000096LBL	L	blue / orange
T4CKS000096MBL	M	blue / orange
T4CKS000096LBE	L	beige
T4CKS000096MBE	M	beige



GHIAIA

GHIAIA is the perfect choice for those who ride gravel bikes. You can wear it during a short ride or a longer bikepacking trip. It is incredibly comfortable and ensures a high level of ventilation with its 23 openings! Furthermore, the Inmold technology perfectly combines light weight and safety. The adjustable dial ensures a great fit and convenience.

SIZES	M (54-58 cm), L (58-62 cm)
WEIGHT	290 g (M), 300 g (L)
VENTILATION OPENINGS	23
ADDITIONAL INFORMATION	Inmold, two-way adjustment

T4CKS000083MBK	M	black
T4CKS000083LBK	L	black
T4CKS000083MGY	M	grey
T4CKS000083LGY	L	grey



PELETON PRO

PELETON PRO is a very well-ventilated training helmet. Perfect both for road and XC racing. Panels reinforced with the Counter Tech® material ensure a new level of head protection. Two-way adjustment system allows to fit not only the width, but also the depth of the helmet. The extremely light weight ensures a stable fit and comfort, even during the longest training sessions.

SIZES	M (54-58 cm), L (58-61 cm)
WEIGHT	205 g (M), 215 g (L)
VENTILATION OPENINGS	21
ADDITIONAL INFORMATION	Inmold, two-way adjustment

T4CKS000034MBK	M	black
T4CKS000034LBK	L	black
T4CKS000034MDBBK	M	dark blue / black
T4CKS000034LDDBK	L	dark blue / black



FLUSSO DONNA

The FLUSSO DONNA helmet is intended for women who actively practice road and XC cycling. Ultra light weight, soft straps and inner sponges are designed with maximum comfort in mind, for women who know what they want from their helmets. The minimalist finish highlights its feminine nature, while the use of the In-Mold technology makes it a stylish accessory that ensures the highest level of protection for the head.

SIZE	M (53,5-59 cm)
WEIGHT	226 g
VENTILATION OPENINGS	24
ADDITIONAL INFORMATION	Inmold, easy to adjust

T4CKS000037MBK	M	black
T4CKS000037MWH	M	white



NEW

RILO

RILO is the ideal choice for cyclists using mainly e-MTB bikes. An efficient ventilation system is provided by 17 vents. It offers the highest level of safety thanks to the use of the modern Triple InMold shell manufacturing technology. The set includes a removable visor, which allows the helmet to adapt to different weather conditions. Easy adjustment with a dial allows you to quickly and comfortably fit the helmet to your head.

SIZES	M (54-58 cm), L (58-62 cm)
WEIGHT	310 g (M), 380 g (L)
VENTILATION OPENINGS	17
ADDITIONAL INFORMATION	Triple InMold, visor included, easy adjustment, Fidlock clasp

T4CKS000105BKL	L	black
T4CKS000105BKM	M	black
T4CKS000105LGR	L	green
T4CKS000105MGR	M	green



NEW

PINTO

Thanks to its 23 vents, the PINTO helmet is a great option for any cyclist who values ventilation while cycling. The helmet is equipped with a visor, which guarantees safety, especially in the forest where protruding branches can cause all sorts of injuries. In addition, the front vents feature mesh, preventing insects from getting under the helmet.

SIZES	M (54-58 cm), L (58-61 cm)
WEIGHT	250 g (M), 310 g (L)
VENTILATION OPENINGS	23
ADDITIONAL INFORMATION	Double InMold, visor included, insect mesh, easy adjustment

T4CKS000099LBK	L	black
T4CKS000099LGY	L	grey
T4CKS000099LRD	L	red
T4CKS000099MBK	M	black
T4CKS000099MGY	M	grey
T4CKS000099MRD	M	red



SALTARE

SALTARE is a high-class MTB helmet that will prove itself during singles. By using the Double Inmold technology, we increased the service life of the helmet, while maintaining all the advantages of the Inmold technology. 23 ventilation openings ensure thermal comfort even on the hottest days. It weighs 320 grams (the M size), which makes it one of the lightest helmets in its class.

SIZES	M (54-58 cm), L (58-62 cm)
WEIGHT	320 g (M), 390 g (L)
VENTILATION OPENINGS	23
ADDITIONAL INFORMATION	Double Inmold, visor included, two-way adjustment

T4CKS000082MBK	M	black
T4CKS000082LBK	L	black
T4CKS000082MRD	M	red
T4CKS000082LRD	L	red



ELEVARE

ELEVARE ensures the right protection, no matter which route you choose. 21 ventilation openings and precise adjustment guarantee comfort of use. You will appreciate its light weight during many hours spent on your bicycle's saddle.

SIZES	M (54-58 cm), L (58-61 cm)
WEIGHT	232 g (M), 248 g (L)
VENTILATION OPENINGS	21
ADDITIONAL INFORMATION	Inmold, two-way adjustment

T4CKS000084MBK	M	black / red
T4CKS000084LBK	L	black / red



ADVENTURO PRO

ADVENTURO PRO is a helmet from the Pro line, designed for advanced cyclists. Equipped with 14 vents, it provides good ventilation, while the front openings with mesh protect against insects. The helmet also has a visor, which is included. Easy adjustment allows the helmet to fit different head sizes for comfortable and safe use. It is the perfect choice for demanding cyclists who value comfort and safety while cycling.

SIZES	M (54-59 cm), L (58-61 cm)
WEIGHT	330 g (M), 350 g (L)
VENTILATION OPENINGS	14
ADDITIONAL INFORMATION	InMold, visor included, insect mesh Easy adjustment

T4CKS000102LGY	L	grey / green
T4CKS000102LMR	L	khaki
T4CKS000102LOR	L	grey / orange
T4CKS000102MGY	M	grey / green
T4CKS000102MMR	M	khaki
T4CKS000102MOR	M	grey / orange



SENTIERO DLX

The SENTIERO DLX helmet is intended for those who fancy forest path rides and need increased protection for their heads. The extra protection is ensured by an ABS outer shell and an EPS inner shell. Both guarantee good head protection even in a strong impact. There is a magnetic system for chin buckle fastening for increased ease of use.

SIZES	M (52-56 cm), L (54-60 cm)
WEIGHT	354 g (M), 400 g (L)
VENTILATION OPENINGS	17
ADDITIONAL INFORMATION	ABS outer shell, EPS inner shell, adjustable visor, magnetic buckle, increased occipital protection

T4CKS000035MBK	M	black
T4CKS000035LBK	L	black
T4CKS000035MRD	M	red
T4CKS000035LRD	L	red



CONGRESSO

CONGRESSO is the best choice for those who look for convenience, top level of protection and a perfect fit for any head shape. Adjustable visor position, two levels of head fit and a magnetic buckle greatly increase comfort during riding.

SIZES	M (54-58 cm), L (58-62 cm)
WEIGHT	290 g (M), 330 g (L)
VENTILATION OPENINGS	18
ADDITIONAL INFORMATION	Double InMold, two-way adjustment, fly net, adjustable visor, magnetic buckle, increased occiput protection

T4CKS000036MBL	M	blue
T4CKS000036LBL	L	blue
T4CKS000036MDGR	M	dark green
T4CKS000036LDGR	L	dark green
T4CKS000036MGY	M	grey
T4CKS000036LGY	L	grey



VINCITORE

VINCITORE is a helmet for a wide variety of users. It will particularly appeal to E-bike and Trekking bike riders. An innovative one-hand adjustment system and a magnetic buckle for the chin straps make it a perfect choice for those who look for a high level of protection combined with convenience of use. The helmet features an integrated fly net, ensuring that nothing more than wind will get through the ventilation openings.

SIZES	M (54-58 cm), L (58-62 cm)
WEIGHT	250 g (M), 310 g (L)
VENTILATION OPENINGS	23
ADDITIONAL INFORMATION	One-hand adjustment, magnetic buckle, insect mesh

T4CKS000038MBK	M	black
T4CKS000038LBK	L	black
T4CKS000038MDB	M	dark blue
T4CKS000038LDB	L	dark blue
T4CKS000038MRD	M	red
T4CKS000038LRD	L	red

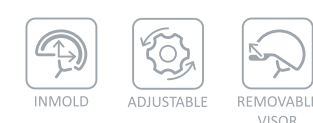

STONO

STONO is a fully-fledged representative of MTB helmets. It has 18 vents for excellent air circulation while riding. It is made using the InMold technology, which ensures durability, lightness, and effective distribution of forces acting on the helmet during impact. STONO also has a visor that protects against the sun, rain, and branches. It is an important piece of equipment for every cyclist and should be chosen carefully to ensure safety while cycling.

SIZES	M (54-58 cm), L (58-62 cm)
WEIGHT	320 g (M), 340 g (L)
VENTILATION OPENINGS	18
ADDITIONAL INFORMATION	InMold, visor included, easy adjustment

T4CKS000103LBK	L	black
T4CKS000103LGY	L	grey
T4CKS000103LRD	L	red
T4CKS000103MBK	M	black
T4CKS000103MGY	M	grey
T4CKS000103MRD	M	red



VENTEGO

The aerodynamic performance of this helmet will satisfy the requirements of even the most demanding riders. An advanced adjustment system will let you comfortably ride many kilometres, ensuring a perfect fit of the helmet. Interchangeable anti-bacterial inserts guarantee comfort even on hot days. Reflective stickers on the back part of the helmet improve safety after dark.

SIZES	M (54-58 cm), L (58-61 cm)
WEIGHT	241 g (M), 258 g (L)
VENTILATION OPENINGS	24
ADDITIONAL INFORMATION	Visor included

T4CKS000004MBK	M	black
T4CKS000004LBK	L	black
T4CKS000004MRD	M	red
T4CKS000004LRD	L	red



ATTIVO

ATTIVO is a perfect choice for any cyclist in search of a comfortable and lightweight headpiece. A very well protected neck area, two-way adjustment system and an affordable price say a lot, but nothing can replace the comfort and great fit the user can experience while wearing this helmet.

SIZES	M (53-56 cm), L (58-61 cm)
WEIGHT	265 g (M), 275 g (L)
VENTILATION OPENINGS	23
ADDITIONAL INFORMATION	Two-way adjustment, increased occipital protection

T4CKS000040MBK	M	black
T4CKS000040LBK	L	black
T4CKS000040MGY	M	grey
T4CKS000040LGY	L	grey
T4CKS000040MRD	M	red
T4CKS000040LRD	L	red



MONTO

The MTB MONTO helmet is an excellent choice for mountain bike enthusiasts. Equipped with 12 vents, it ensures optimum air circulation, keeping your head cool and dry even during intense exercise. The visor protects you from the sun and minor precipitation, providing better visibility on the trail. Made with the InMold technology, the helmet is durable and lightweight for a comfortable ride. The insect mesh effectively protects you against unwanted visitors. Easy adjustment allows you to adapt the helmet to your size for a perfect fit. MONTO is not only about functionality, but also about safety and comfort during your adventures on mountain trails.

SIZES	M (53-59 cm)
WEIGHT	230 g (M)
VENTILATION OPENINGS	12
ADDITIONAL INFORMATION	InMold, visor included, insect mesh
	Easy adjustment

T4CKS000100MBK	M	black
T4CKS000100MRD	M	red



BRIZO

BRIZO is perfect for those who enjoy their rides and want to look good at the same time. A comfortable helmet both for more and less advanced cyclists. Light weight ensures comfort even during longer bike trips. Ventilation system and interchangeable, anti-bacterial inserts ensure comfort even on hot days. Reflective stickers on the back part of the helmet improve safety after dark.

SIZES	M (54-58 cm), L (58-61 cm)
WEIGHT	221 g (M), 229 g (L)
VENTILATION OPENINGS	28
ADDITIONAL INFORMATION	Visor included, antibacterial inserts, stickers that improve safety after dark

T4CKS000007MBKLM	M	black / yellow
T4CKS000007LBKLM	L	black / yellow
T4CKS000007MGYOR	M	grey / orange
T4CKS000007LGYOR	L	grey / orange
T4CKS000007MWHVI	M	white / blue
T4CKS000007LWHVI	L	white / blue



BORAO III

BORAO is intended for those who are just beginning their cycling adventure. Attractive colors, good ventilation and light weight are among the advantages of this helmet. Detachable visor ensures protection from branches for those who like to ride in the woods. The convenient adjustment system, as well as the thin, ventilated chin straps that improve ventilation are also worth mentioning.

SIZES	M (54-58 cm), L (58-61 cm)
WEIGHT	235 g (M), 250 g (L)
VENTILATION OPENINGS	22
ADDITIONAL INFORMATION	Inmold, easily adjustable, ventilated straps

T4CKS000081MDB	M	dark blue
T4CKS000081LDB	L	dark blue
T4CKS000081MBK	M	black
T4CKS000081LBK	L	black



NEW

CAPITALO

The CAPITALO helmet is specifically designed for urban mobility. Its "nut" shape is ideal for cycling enthusiasts in crowded city streets. Adequate ventilation is provided by 12 openings. Thanks to the InMold technology, the helmet perfectly combines lightness and safety.

SIZES	M (54-58 cm), L (58-61 cm)
WEIGHT	320 g (M), 375 g (L)
VENTILATION OPENINGS	12
ADDITIONAL INFORMATION	InMold, easy adjustment, insect mesh

T4CKS000094LBL	L	blue
T4CKS000094LGR	L	green
T4CKS000094MBL	M	blue
T4CKS000094MGR	M	green



LAKI

LAKIA was designed for those who value excellent head ventilation during every bike trip. Light weight ensures comfort for long rides. Interchangeable anti-bacterial inserts provide comfort in higher temperatures. Reflective stickers on the back part of the helmet improve safety after dark.

SIZES	M (56-58 cm), L (58-61 cm)
WEIGHT	212 g (M), 221 g (L)
VENTILATION OPENINGS	28
ADDITIONAL INFORMATION	Visor included, antibacterial inserts, stickers that improve safety after dark

T4CKS000008MGY	M	grey
T4CKS000008LGY	L	grey
T4CKS000008MPI	M	pink
T4CKS000008LPI	L	pink
T4CKS000008MGR	M	green
T4CKS000008LGR	L	green
T4CKS000008MLZ	M	light blue
T4CKS000008LLZ	L	light blue



SALT FF

SALT FF is a youth full-face helmet featuring a detachable chin bar which, when removed, can convert into an MTB helmet. The InMold technology ensures safety and lightness. Excellent ventilation is provided by 14 openings. An adjustable dial guarantees a great fit and comfort. In addition, mesh is installed in the front openings to prevent insects from getting under the helmet.

SIZES	S (51-55 cm)
WEIGHT	445 g (S)
VENTILATION OPENINGS	14
ADDITIONAL INFORMATION	Detachable chin bar, InMold, visor included, insect mesh, easy adjustment

T4CKS000098SBK	S	purple
T4CKS000098SGY	S	grey

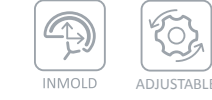

SUPER HERO

SUPER HERO was designed for young cyclists who need an extra protection for their cycling adventures. A sturdy shell protects the head even against very strong impacts and the one-hand adjustment system will help to find a perfect fit before each ride. Magnetic buckle fastening system makes it easier to fasten the chin straps.

SIZES	XS (48-53 cm), S (52-56 cm)
WEIGHT	255 g (XS), 266 g (S)
VENTILATION OPENINGS	12
ADDITIONAL INFORMATION	Inmold, easily adjustable, magnetic buckle

T4CKS000041XSBK	XS	black
T4CKS000041SBK	S	black
T4CKS000041XSRD	XS	red
T4CKS000041SRD	S	red
T4CKS000041XSGY	XS	grey
T4CKS000041SGY	S	grey
T4CKS000041XSGR	XS	green
T4CKS000041SGR	S	green



INFANO

INFANO is an advanced helmet for the youngest cycling enthusiasts. It provides a high level of comfort and safety with all the necessary certifications. An integrated visor protects the most curious young cyclists against tree branches on forest paths. Reflective stickers increase safety.

SIZES	XS (48-52 cm), S (52-56 cm)
WEIGHT	180 g (XS), 211 g (S)
VENTILATION OPENINGS	16
ADDITIONAL INFORMATION	Integrated visor, stickers that improve safety after dark

T4CKS000014XSBL	XS	blue
T4CKS000014SBL	S	blue
T4CKS000014XSPI	XS	pink
T4CKS000014SPI	S	pink
T4CKS000014XSRD	XS	red
T4CKS000014SRD	S	red
T4CKS000014XSVI	XS	purple
T4CKS000014SVI	S	purple
T4CKS000014XSWH	XS	white
T4CKS000014XSYL	XS	yellow
T4CKS000014SYL	S	yellow
T4CKS000014XSYLOR	XS	yellow / orange
T4CKS000014SYLOR	S	yellow / orange



MOTRIP

MoTrip is a lightweight, comfortable, high-quality helmet for beginner and intermediate users. It is extremely comfortable and features many a technology from the world of performance cycling, while ensuring a high level of safety. The helmet is equipped with a visor that is useful during long rides in the mountains.

SIZES	M (54-58 cm), L (58-62 cm)
WEIGHT	330 g (M), 360 g (L)
VENTILATION OPENINGS	14
ADDITIONAL INFORMATION	Optimum for performance mountain biking, adjustable visor, increased occipital protection

T4CKS000089LBL	M	blue
T4CKS000089MBL	L	blue



APPAREL

HEADWEAR





TUBE

A versatile scarf made of a breathable and quick-drying fabric provides comfort in various weather conditions. The seamless technology makes it gentle on the skin and very comfortable to use. Perfect both for long training sessions and out-of-town trips.

MATERIAL	Polyester
SIZE	One size
	Made in Poland

T4COD00057BK	OS	black
T4COD00057RD	OS	red
T4COD00057BL	OS	blue
T4COD00057GY	OS	grey
T4COD00057AQ	OS	pattern
T4COD00057GR	OS	pattern



TUBE THERMO

A versatile scarf made of a breathable and quick-drying fabric with fleece lining provides comfort on cold days. Perfect both for long training sessions and out-of-town trips.

MATERIAL	Polyester
SIZE	One size
	Made in Poland

T4COD00058BK	OS	black
T4COD00058RD	OS	red



CLASSIC

A classic cap made of polyester. It protects you from draught, which might be dangerous even on warm days. A flexible tape inside ensures a perfect fit and absorbs sweat at the same time. The cap is a great protection against the sun and insects.

MATERIAL	100% Polyester
SIZE	One size
	Made in Poland

T4COD00061BK	OS	black
T4COD00061RD	OS	red
T4COD00061BL	OS	blue



LOMBARDIA 2.0

A winter hat made of the Lombardia fabric. Inspired by old Belgian cycling caps. Made of an innovative fabric that is resistant to water splashes and maintains its thermal protection properties even when it is wet. The visor serves as an additional means of protection against rain and snow. When worn under the helmet, the reflective element on the visor increases safety.

MATERIAL	Lombardia
SIZES	S/M, L/XL
	Made in Poland

T4COD00062SMBK	S/M	black
T4COD00062LXLBK	L/XL	black
T4COD00062SMFL	S/M	yellow fluo
T4COD00062LXLFL	L/XL	yellow fluo



THERMO CAP

An under-helmet winter cap. Made of a SoftShell membrane and fleece. The membrane protects the sensitive parts of the head, while fleece ensures proper ventilation.

MATERIAL	Softshell, Fleece
SIZES	S/M, L/XL
	Made in Poland

T4COD00063SMBK	S/M	black
T4COD00063LXLBK	L/XL	black
T4COD00063SMFL	S/M	yellow fluo



WRAP

Headband made of a flexible SoftShell membrane. The anatomical cut protects the sensitive parts of the head and ears. Can be used for cycling, as well as for other activities (such as running, skiing etc.).

MATERIAL	Softshell
SIZE	One size
	Made in Poland

T4COD00059BK	OS	black
T4COD00059RD	OS	red
T4COD00059BL	OS	blue



WRAP LADY

Headband made of a flexible SoftShell membrane. The anatomical cut protects the sensitive parts of the head and ears. Can be used for cycling, as well as for other activities (such as running, skiing etc.).

MATERIAL	Softshell
SIZE	One size
	Made in Poland

T4COD00060BK	OS	black
T4COD00060RD	OS	red



WRAP THERMO

Scarf made of a stretchable SoftShell membrane with fleece lining; provides comfort on cold days. The anatomical cut protects the sensitive parts of the head and ears. Can be used for cycling, as well as for other activities (such as running, skiing etc.).

MATERIAL	Softshell
SIZES	L/XL
	Made in Poland

T4COD00064LXLBK	L/XL	black
------------------------	------	-------



WRAP THERMO LADY

Scarf made of a stretchable SoftShell membrane with fleece lining; provides comfort on cold days. The anatomical cut protects the sensitive parts of the head and ears. Can be used for cycling, as well as for other activities (such as running, skiing etc.).

MATERIAL	Softshell
SIZES	S/M, L/XL
	Made in Poland

T4COD00065SMBK	S/M	black
T4COD00065LXLBK	L/XL	black



BEANIE

A classic cap for those who want to show off their passion. Ensures thermal comfort for the head and is a great choice for all the long hours spent away from the bicycle saddle.

MATERIAL	Acrylic yarn
SIZE	One size
	Made in Poland

T4COD00070BK	OS	black
T4COD00070GY	OS	deep red



BEANIE EDGE

A charming winter cap for all cycling enthusiasts. Ensures thermal comfort for the head and is a great choice for all the long hours spent away from the bicycle saddle.

MATERIAL	Acrylic yarn
SIZE	One size
	Made in Poland

T4COD00069BK	OS	marine
T4COD00069GY	OS	grey



APPAREL

EYEWEAR





NEW

FLY

FLY glasses have large photochromic lenses that provide protection against the sun and wind. These lenses adapt to changing lighting conditions, ensuring optimum visibility both day and night. They feature replaceable rubber nose pads.

FRAME MATERIAL	TR90 – Swiss Grilamid
LENS MATERIAL	Polycarbonate
FILTER	UV400
ADDITIONAL INFORMATION	Anti-scratch, photochromic lenses
CONFORMITY TO STANDARDS	EN ISO 12312-1:2013(A1:2015) ANSI Z80.3:2018 and AS/NZS 10671:2016. Compliance with the SGS PPE EU 2016/425 Class 1 self-declaration standard.

T4COK000045BK



NEW

FLASH

FLASH glasses are the perfect cycling glasses for sunny days. Polarised lenses with a REVO coating ensure excellent contrast and protect against glare. They feature replaceable rubber nose pads.

FRAME MATERIAL	TR90 – Swiss Grilamid
LENS MATERIAL	Polycarbonate
FILTER	UV400
ADDITIONAL INFORMATION	REVO, Anti Finger-Print, Anti Scratch, polarised lenses
CONFORMITY TO STANDARDS	EN ISO 12312-1:2013(A1:2015) ANSI Z80.3:2018 and AS/NZS 10671:2016. Compliance with the SGS PPE EU 2016/425 Class 1 self-declaration standard.

T4COK000041BK



NEW

BRAKER

BRAKER glasses were designed with versatility in mind. They have a removable frame and interchangeable lenses for both day and night cycling. Thanks to this, you can easily adapt to different lighting conditions and enjoy optimum visibility during your cycling adventures.

FRAME MATERIAL	TR90 – Swiss Grilamid
LENS MATERIAL	Polycarbonate
FILTER	UV400
ADDITIONAL INFORMATION	Anti-fog and anti-scratch coating, removable frame, replaceable lenses: yellow, blue.
CONFORMITY TO STANDARDS	EN ISO 12312-1:2013(A1:2015), ANSI Z80.3:2018 and AS/NZS 10671:2016. Compliance with the SGS PPE EU 2016/425 Class 1 self-declaration standard.

T4COK000042BG



NEW

EARTH

EARTH cycling glasses provide comfort and freedom. The ventilation system effectively drains moisture, keeping you fresh and comfortable even during intense exercise. Polarised lenses reduce glare and improve contrast, providing excellent eye protection in a variety of lighting conditions.

FRAME MATERIAL	TR90 – Swiss Grilamid
LENS MATERIAL	Polycarbonate
FILTER	UV400
ADDITIONAL INFORMATION	Anti-scratch, polarised lenses, adjustable nose pads
CONFORMITY TO STANDARDS	EN ISO 12312-1:2013(A1:2015)

T4COK000035BR



MOON

The MOON goggles were designed with the most demanding users in mind. Robust, yet flexible frames hold lenses that feature the Polarized clear vision technology. The Anti-Fog treatment enables them to be used even for the greatest effort, without the hassle of foggy lenses.

FRAME MATERIAL	TR90
LENS MATERIAL	Polycarbonate
FILTER	UV400
ADDITIONAL INFORMATION	Anti-Fog, Polarized, Anti Scratch

T4COK000026BK black
T4COK000026BKRD black / red



PURE RIDE

The classic PURE RIDE model was designed for those who are looking for a robust and flexible frame. Alongside these properties, we managed to keep the weight very light. Reinforced lenses with Anti-Fog technology allow you to enjoy your ride longer, even if the conditions are rough.

FRAME MATERIAL	CX
LENS MATERIAL	Polycarbonate
FILTER	UV400
ADDITIONAL INFORMATION	Anti-Fog, REVO

T4COK000027BK black
T4COK000027BKVI black / purple



PELETON

The PELETON road cycling goggles made of a flexible material are highly resistant to deformation. Spherical lenses guarantee clear vision over the entire lens surface. Additionally, they also feature flexible side arms that can be individually adjusted.

FRAME MATERIAL	TR90
LENS MATERIAL	Polycarbonate
FILTER	UV400
ADDITIONAL INFORMATION	REVO

T4COK000029BK	black
T4COK000029BKLBL	black / blue



FEMI LINE

The FEMI LINE goggles feature a contemporary look, but also are very functional thanks to the soft finishing elements and large, spherical lenses that protect a large part of the face. Interchangeable lenses included in the set allow you to adjust your goggles to any weather conditions.

FRAME MATERIAL	TR90
LENS MATERIAL	Polycarbonate
FILTER	UV400
ADDITIONAL INFORMATION	REVO, interchangeable lenses: black REVO in the shades of purple, white, yellow

T4COK000030BKVI	black / purple
T4COK000030WHGR	white / green



PAVE

PAVE goggles have a timeless sporty style. Made of a lightweight material, the TR90, that increases the comfort of wearing thanks to its flexibility. The spherical lenses used do not distort the image and increase contrast, improving visibility on sunny days.

FRAME MATERIAL	TR90
LENS MATERIAL	Polycarbonate
FILTER	UV400
ADDITIONAL INFORMATION	Interchangeable lenses: black REVO, white, yellow

T4COK000033BK	black
T4COK000033BKBL	black / blue
T4COK000033BKREV	black / revo
T4COK000033WHBL	white / blue



FLOW

The Kross FLOW lightweight cycling goggles feature lenses made of polycarbonate. The lenses are spherical, meaning that the image is not distorted on their margins.

FRAME MATERIAL	Polycarbonate
LENS MATERIAL	Polycarbonate
FILTER	UV400
ADDITIONAL INFORMATION	REVO

T4COK000034BK	black
T4COK000034BKBL	black / blue
T4COK000034BKRD	black / red



PODIUM 2.0

Very comfortable goggles intended for everyday use. Made of the durable TR90 material, with high-quality lenses featuring UV400 protection. Perfect for city walks, as well as for the moment when you step onto the highest podium to grab your prize in bright sun.

FRAME MATERIAL	TR90
LENS MATERIAL	Polycarbonate
FILTER	UV400

T4COK000031BKGLD	black / golden
T4COK000031BKVI	black / purple
T4COK000031DBL	dark blue
T4COK000031DRD	dark red



APPAREL

GLOVES

KROSS





ROCKER

ROCKER, typical Enduro gloves, lightweight and breathable. Ensure maximum thermal comfort. Minimal foam padding on the underside for a more secure grip. Silicone print on the index and middle fingers, as well as on thumb ensure better control of brakes and gears. Velcro fastening for better fit.

MATERIAL	Top layer: Nylon, Elastane. Bottom layer: Polyester, Polyurethane
FASTENER	Velcro
SIZES	S, M, L, XL, XXL

T4COD00287SBK	S	black
T4COD00287MBK	M	black
T4COD00287LBK	L	black
T4COD00287XLBK	XL	black
T4COD00287XXLBK	XXL	black
T4COD00287SBKRD	S	black / red
T4COD00287MBKRD	M	black / red
T4COD00287LBKRD	L	black / red
T4COD00287XLBKRD	XL	black / red
T4COD00287XXLBKRD	XXL	black / red
T4COD00287SGY	S	grey
T4COD00287MGY	M	grey
T4COD00287LGY	L	grey
T4COD00287XLGY	XL	grey
T4COD00287XXLGY	XXL	grey



RACE LONG 3.0

RACE LONG 3.0 feature a minimalist and ultralight design. Made with marathon and XC racing enthusiasts in mind. No padding on the underside for a firm grip and light weight. The top layer is made of a very thin mesh to prevent overheating. No Velcro fastening for further weight reduction and increased freedom of movement.

MATERIAL	Nylon Polyurethane, Nylon Spandex, Polyester Spandex, Polyester
SIZES	S, M, L, XL, XXL

T4COD00295SGY	S	grey
T4COD00295MGY	M	grey
T4COD00295LGY	L	grey
T4COD00295XLGY	XL	grey
T4COD00295XXLGY	XXL	grey
T4COD00295SWH	S	white
T4COD00295MWH	M	white
T4COD00295LWH	L	white
T4COD00295XLWH	XL	white
T4COD00295XXLWH	XXL	white
T4COD00295SRD	S	red
T4COD00295MRD	M	red
T4COD00295LRD	L	red
T4COD00295XLRD	XL	red
T4COD00295XXLRD	XXL	red



FLOW FEMI LINE LF

FLOW FEMI LINE LF are gloves designed for women. The top panel is made of a four-way material that ensures a perfect fit and a high level of ventilation. Pile-fabric finish on the thumb provides comfort during effort.

MATERIAL	Top layer: Nylon, Elastane Bottom layer: Polyurethane, Nylon
FASTENING	Velcro
SIZES	XS, S, M, L

T4COD00283SBKTQ	XS	black / blue-green
T4COD00283SBKTQ	S	black / blue-green
T4COD00283MBKTQ	M	black / blue-green
T4COD00283LBKTQ	L	black / blue-green
T4COD00283XSBK	XS	black
T4COD00283SBK	S	black
T4COD00283MBK	M	black
T4COD00283LBK	L	black



RACE SHORT 3.0

The minimalist and ultra light design of the RACE SHORT 3.0 gloves makes them a perfect choice for XC and road racing enthusiasts. No padding on the underside for a firm grip and light weight. The top layer is made of a very thin Lycra to prevent overheating. No Velcro fastening for further weight reduction and increased freedom of movement.

MATERIAL	Nylon Polyurethane, Nylon Spandex, Polyester Spandex, Polyester
SIZES	S, M, L, XL, XXL

T4COD00296SGY	S	grey
T4COD00296MGY	M	grey
T4COD00296LGY	L	grey
T4COD00296XLGY	XL	grey
T4COD00296XXLGY	XXL	grey
T4COD00296SWH	S	white
T4COD00296MWH	M	white
T4COD00296LWH	L	white
T4COD00296XLWH	XL	white
T4COD00296XXLWH	XXL	white
T4COD00296SRD	S	red
T4COD00296MRD	M	red
T4COD00296LRD	L	red
T4COD00296XLRD	XL	red
T4COD00296XXLRD	XXL	red



FLOW FEMI LINE SF

The FLOW Femi Line SF model was designed specifically with women's hands in mind. They are made of a breathable and soft material that is just perfect for hot days. Additionally, the bottom part was made of soft artificial leather and its anatomical shape features gel panels located at the points of greatest pressure on the handlebars, increasing comfort during cycling.

MATERIAL	Top layer: Nylon, Elastane Bottom layer: Polyurethane, Nylon
FASTENING	Rzep
SIZES	XS, S, M, L

T4COD00290XSBL	XS	blue
T4COD00290SBL	S	blue
T4COD00290MBL	M	blue
T4COD00290LBL	L	blue
T4COD00290XSBK	XS	black
T4COD00290SBK	S	black
T4COD00290MBK	M	black
T4COD00290LBK	L	black
T4COD00290XSDBL	XS	dark blue
T4COD00290MDBL	M	dark blue
T4COD00290SDBL	S	dark blue
T4COD00290LDBL	L	dark blue



FLOW 2.0

The FLOW 2.0 cycling gloves are made of a durable material and artificial leather. The top panel is made of a stretchy Lycra that ensures a perfect fit and a high level of ventilation. Pile-fabric finish on the thumb provides comfort during even the longest rides.

MATERIAL	Top layer: Nylon, Elastane Bottom layer: Polyurethane, Nylon
SIZES	S, M, L, XL, XXL

T4COD00291SGY	S	grey
T4COD00291MGY	M	grey
T4COD00291LGY	L	grey
T4COD00291XLGY	XL	grey
T4COD00291XXLGY	XXL	grey
T4COD00291SDBL	S	dark blue
T4COD00291MDBL	M	dark blue
T4COD00291LDBL	L	dark blue
T4COD00291XLDL	XL	dark blue
T4COD00291XXLDBL	XXL	dark blue
T4COD00291SRD	S	red
T4COD00291MRD	M	red
T4COD00291LRD	L	red
T4COD00291XLRD	XL	red
T4COD00291XXLRD	XXL	red



ACTIVE

ACTIVE is a model designed for all cycling enthusiasts. These gloves feature gel inserts that increase comfort while riding, as well as a highly breathable top part that covers the hands. A durable Velcro strap allows for a perfect fit on the wrist.

MATERIAL	Top layer: Nylon, Elastane Bottom layer: Polyurethane, Nylon
SIZES	S, M, L, XL, XXL

T4COD00286SRD	S	red
T4COD00286MRD	M	red
T4COD00286LRD	L	red
T4COD00286XLRD	XL	red
T4COD00286XXLRD	XXL	red
T4COD00286SGY	S	grey
T4COD00286MGY	M	grey
T4COD00286LGY	L	grey
T4COD00286XLY	XL	grey
T4COD00286XXLY	XXL	grey
T4COD00286SDBL	S	dark blue
T4COD00286MDBL	M	dark blue
T4COD00286LDBL	L	dark blue
T4COD00286XLDL	XL	dark blue
T4COD00286XXLDL	XXL	dark blue



ROAMER LADY

ROAMER LADY is a basic model of cycling gloves for all women who like to ride their bicycles. A special fit designed for women. Perfect for out-of-town trips and city traffic. The right texture of the bottom material ensures firm grip and control of the handlebars. Short-finger versions ensure good ventilation and an efficient control of brakes and gears. Velcro strap ensures a good fit.

MATERIAL	Top layer: Nylon, Elastane Bottom layer: Polyester
FASTENING	Velcro
SIZES	XS, S, M, L

T4COD000030XSAQ	XS	aquamarine
T4COD000030SAQ	S	aquamarine
T4COD000030MAQ	M	aquamarine
T4COD000030LAQ	L	aquamarine
T4COD000030XSGR	XS	green
T4COD000030SGR	S	green
T4COD000030MGR	M	green
T4COD000030LGR	L	green
T4COD000030XSPIBL	XS	pink / blue
T4COD000030SPIBL	S	pink / blue
T4COD000030MPIBL	M	pink / blue
T4COD000030LPIBL	L	pink / blue
T4COD000030XSVI	XS	purple
T4COD000030SVI	S	purple
T4COD000030MVI	M	purple
T4COD000030LVI	L	purple



ROAMER

ROAMER is a basic model of cycling gloves. Perfect for out-of-town trips and city traffic. The right texture of the bottom material ensures firm grip and control of the handlebars. Short-finger versions ensure good ventilation and an efficient control of brakes and gears. Velcro strap ensures a good fit.

MATERIAL	Top layer: Nylon, Elastane Bottom layer: Polyester
FASTENING	Velcro
SIZES	S, M, L, XL, XXL

T4COD000031SBK	S	black
T4COD000031MBK	M	black
T4COD000031LBK	L	black
T4COD000031XLBK	XL	black
T4COD000031XXLBK	XXL	black
T4COD000031SBL	S	blue
T4COD000031MBL	M	blue
T4COD000031LBL	L	blue
T4COD000031XLBL	XL	blue
T4COD000031XXLBL	XXL	blue
T4COD000031SGR	S	green
T4COD000031MGR	M	green
T4COD000031LGR	L	green
T4COD000031XLGR	XL	green
T4COD000031XXLGR	XXL	green
T4COD000031SRD	S	red
T4COD000031MRD	M	red
T4COD000031LRD	L	red
T4COD000031XLRD	XL	red
T4COD000031XXLRD	XXL	red



JOY

JOY is the name of high-quality gloves for all those young ones who begin their cycling journey. High-quality materials, such as Amara or Lycra, ensure long life of the gloves. They are perfect for rides in the park, as well as for having fun at the nearby playground. Velcro strap ensures a good fit.

MATERIAL	Top layer: Lycra Bottom layer: Amara
FASTENING	Velcro
SIZES	XS, S, M

T4COD000032XSBKWH	XS	black / white
T4COD000032SBKWH	S	black / white
T4COD000032MBKWH	M	black / white
T4COD000032XSBL	XS	blue
T4COD000032SBL	S	blue
T4COD000032MBL	M	blue
T4COD000032XSLZ	XS	light blue
T4COD000032MLZ	M	light blue
T4COD000032XSPI	XS	pink
T4COD000032SPI	S	pink
T4COD000032MPI	M	pink
T4COD000032XSYL	XS	yellow
T4COD000032SYL	S	yellow
T4COD000032MYL	M	yellow
T4COD000032XSYLPI	XS	yellow / pink
T4COD000032SYLPI	S	yellow / pink
T4COD000032MYLPI	M	yellow / pink
T4COD000032XSBLWH	XS	blue / white
T4COD000032SBLWH	S	blue / white
T4COD000032MBLWH	M	blue / white
T4COD000032XSVI	XS	purple
T4COD000032SVI	S	purple
T4COD000032MVI	M	purple



THERMAL 5F

Gloves with synthetic filling for increased thermal comfort. Outer shell is a membrane material to ensure waterproofness and breathability. They are long enough to reach the jacket cuffs, which guarantees good protection against low temperatures (below -10 degrees).

MATERIAL	Taslan / Fleece / Waterproof membrane
FASTENING	Elastic band with drawstring
SIZES	S, M, L, XL, XXL

T4COD00293S	S	black
T4COD00293M	M	black
T4COD00293L	L	black
T4COD00293XL	XL	black
T4COD00293XXL	XXL	black



THERMAL 3F

Three finger gloves with synthetic filling for increased thermal comfort. Outer shell is a membrane material to ensure waterproofness and breathability. They are long enough to reach the jacket cuffs, which guarantees good protection against low temperatures (below -10 degrees).

MATERIAL	Taslan / Fleece / Waterproof membrane
FASTENING	Elastic band with drawstring
SIZES	S, M, L, XL, XXL

T4COD00292S	S	black
T4COD00292M	M	black
T4COD00292L	L	black
T4COD00292XL	XL	black
T4COD00292XXL	XXL	black



CONTROVENTO 2.0

High-class gloves intended for windy and humid weather. The material used repels rain, ensuring comfort all the way to your destination. Ventilation panels between fingers allow to cover many kilometres in comfort, even when it takes considerable effort. Elongated design and a robust Velcro fastening efficiently protect against cold air. Anatomically arranged panels reduce the appearance of calluses, even after many hours of cycling. Silicone print provides a secure grip and precise control of brakes and gears.

MATERIAL	PU, SBR, Polyester, Nylon, Artificial leather / Anti-wind
FASTENING	Velcro
SIZES	S, M, L, XL, XXL

T4COD00294S	S	red
T4COD00294M	M	red
T4COD00294L	L	red
T4COD00294XL	XL	red
T4COD00294XXL	XXL	red



APPAREL

JACKETS





ARBARO JKT

ARBARO JKT is an ultralight jacket made from thin fabric with a membrane. It features a tailored fit with an extended rear panel. The covered zipper and windproof strip under the zipper protect against wind. The high collar provides comfort while riding. Openings under the arms allow for better ventilation. Reflective elements enhance safety on the road. Three pockets on the rear panel offer the possibility to store small items. The sleeve cuff is made from elastic fabric and finished seamlessly with laser cutting.

MATERIAL	100% Polyester
ADDITIONAL INFORMATION	<ul style="list-style-type: none"> Ultralight, can be folded and stored in a bag or pocket Windproof and waterproof fabric A tailored fit with an extended rear panel Covered zip Windproof strip under the main zipper High collar for increased comfort when riding in windy conditions Underarm zips for increased ventilation Discreet reflective elements for improved safety from black reflex material Three-part back pocket on the jacket with an additional zippered pocket in the side seam Elastic sleeve cuff finished seamlessly with laser cutting Made in Poland

T4COD200010L	L	black
T4COD200010M	M	black
T4COD200010S	S	black
T4COD200010XL	XL	black
T4COD200010XXL	XXL	black



VOJAGO JKT

VOJAGO JKT is a lightweight and insulated cycling jacket made from a medium-weight membrane material, characterized by water resistance up to 8100 mm water column. Its tailored fit and extended rear panel provide comfort during rides. A windproof strip under the zipper protects against wind, and a high collar enhances comfort in windy conditions. The jacket features a three-part back pocket, including an additional zippered pocket for storing small items during rides. The sleeves are finished with an elastic cuff, which is seam-sealed for a seamless design.

MATERIAL	Polyester, Elastane
ADDITIONAL INFORMATION	<ul style="list-style-type: none"> Lightweight and insulated Windproof and waterproof fabric rated up to 8100 mm H2O Tailored fit with an extended rear panel High collar for increased comfort when riding in windy conditions Zipper garages at the top and bottom of the zipper to protect against abrasions Windproof strip under the main zipper A three-part back pocket on the jacket with an additional zippered pocket in the middle panel. Sleeves finished with an elastic cuff that is seam-sealed for a seamless design Made in Poland

T4COD200009L	L	black
T4COD200009M	M	black
T4COD200009S	S	black
T4COD200009XL	XL	black
T4COD200009XXL	XXL	black



VETURO JKT

VETURO JKT – an ultralight padded MTB jacket. Waterproof fabric with a three-layer membrane protects the cyclist from getting wet. A slim fit with an extended back panel provides extra comfort and convenience while cycling. Adjustable underarm zips ensure ventilation. Reflective elements increase visibility for safety. The jacket features extended cuffs with thumb holes for a better fit and protection.

MATERIAL	Polyamid, Elastane
ADDITIONAL INFORMATION	<ul style="list-style-type: none"> Ultralight and foldable, it can be easily folded and stowed in a pouch or pocket Hydrophobic waterproof and windproof fabric Tailored fit with an extended rear panel Covered zipper Windproof strip under the main zipper High collar for increased comfort when riding in windy conditions Underarm zips for increased ventilation Subtle reflective elements made from black reflex material, enhancing safety Zipper garages at the top and bottom of the zipper to protect against abrasions Sleeves finished with an elastic fabric cuff for comfortable use Made in Poland

T4COD200008L	L	black
T4COD200008M	M	black
T4COD200008S	S	black
T4COD200008XL	XL	black
T4COD200008XXL	XXL	black



NEW



FORET JKT

FORET JKT - the perfect jacket for MTB enthusiasts. Made from hydrophobic and windproof fabric, providing effective protection against rain and wind. A windproof strip is placed under the zipper to prevent wind from penetrating through the zipper coil. Zipper garages at the top and bottom protect against fabric abrasion and damage. Discreet reflective elements on the jacket enhance safety on the road

MATERIAL	100% Polyester
ADDITIONAL INFORMATION	Hydrophobic and windproof fabric
	Reflective elements that enhance visibility on the road
	Tailored fit with an extended rear panel
	Zipper garages at the top and bottom of the zipper to protect against abrasions
	Made in Poland

T4COD200011S	S	grey
T4COD200011M	M	grey
T4COD200011L	L	grey
T4COD200011XL	XL	grey
T4COD200011XXL	XXL	grey



NEW



GRUNDO JKT

GRUNDO JKT is a jacket designed for MTB enthusiasts. Lightly insulated and made from a blend of Polyamide and Elastane, it offers comfort, flexibility, and effective moisture-wicking, making it ideal for active cyclists. Reflective elements on the front and back of the jacket enhance visibility on the road, improving safety. Zipper garages at the bottom and top protect against fabric damage. The zipper is equipped with an Auto-lock function to minimize the risk of accidental opening, which is especially important during dynamic rides

MATERIAL	Polyamid, Elastane
ADDITIONAL INFORMATION	Lightly insulated fabric
	Reflective elements that enhance visibility on the road
	Tailored fit with an extended rear panel
	Zipper garages at the top and bottom of the zipper to protect against abrasions
	Made in Poland

T4COD200007L	L	black
T4COD200007M	M	black
T4COD200007S	S	black
T4COD200007XL	XL	black
T4COD200007XXL	XXL	black



FLURRY

FLURRY is a very lightweight jacket featuring a waterproof membrane. Glued seams and a sealed zip further enhance its performance. The compact size of the jacket makes it easy to carry around, as it will fit into the back pocket of your cycling jersey.

MATERIAL	100% Poliester
ADDITIONAL INFORMATION	Sleeves finished with an elastic fabric cuff for comfortable use
	Waterproof zipper
	Waterproofness rated at 5000 mm H ₂ O
	Moisture vapor permeability (MVP) rating of 500
	Silicone tape around the waist
	Waterproof welded seams
	Reflective elements that enhance visibility on the road
	Can be folded to a compact size
WEIGHT	130 g

T4COD000085S	S	black
T4COD000085M	M	black
T4COD000085L	L	black
T4COD000085XL	XL	black
T4COD000085XXL	XXL	black



ETHER

ETHER is a very thin jacket that will warm you up during cycling trips on colder and windy days. It features an integrated carrying bag, so that you can fold it into a mini size and carry wherever you want.

MATERIAL	100% Polyester 20D WRINKLE
ADDITIONAL INFORMATION	Sleeves finished with an elastic fabric cuff for comfortable use
	Silicone tape around the waist
	Reflective elements that enhance visibility on the road
	Can be folded to a compact size
	Windproof main fabric
	Water repellent
WEIGHT	104 g

T4COD200002SLGR	S	light green
T4COD200002MLGR	M	light green
T4COD200002LLGR	L	light green
T4COD200002XLLGR	XL	light green
T4COD200002SOR	S	orange
T4COD200002MOR	M	orange
T4COD200002LOR	L	orange
T4COD200002XLOR	XL	orange



PONCHO

A waterproof single-piece rain poncho that ensures optimum protection on rainy days.

MATERIAL	Polyester, Polyurethane
	Made in Poland

T4COD200006XSS	XS/S	black
T4COD200006ML	M/L	black
T4COD200006XLXXL	XL/XXL	black



APPAREL

FLEECEES & HOODIES





TEAM HOODIE

This high-quality HOODIE is perfect for any cycling enthusiast. It is made of a stretchable and smooth fabric for increased comfort. Great for bike rides and as a casual outfit.

MATERIAL	Cotton
ADDITIONAL INFORMATION	Hand wash in 30° C
SIZES	S, M, L, XL
	Made in Poland

T4CDBL0002SBK	S	black
T4CDBL0002MBK	M	black
T4CDBL0002LBK	L	black
T4CDBL0002XLBK	XL	black
T4CDBL0002SGY	S	grey
T4CDBL0002MGY	M	grey
T4CDBL0002LGY	L	grey
T4CDBL0002XLY	XL	grey



NEW



GRUNDO JKT

GRUNDO JKT is a jacket designed for MTB enthusiasts. Lightly insulated and made from a blend of Polyamide and Elastane, it offers comfort, flexibility, and effective moisture-wicking, making it ideal for active cyclists. Reflective elements on the front and back of the jacket enhance visibility on the road, improving safety. Zipper garages at the bottom and top protect against fabric damage. The zipper is equipped with an Auto-lock function to minimize the risk of accidental opening, which is especially important during dynamic rides

MATERIAL	Polyamid, Elastane
ADDITIONAL INFORMATION	Lightly insulated fabric
	Reflective elements that enhance visibility on the road
	Tailored fit with an extended rear panel
	Zipper garages at the top and bottom of the zipper to protect against abrasions
	Made in Poland

T4COD200007L	L	black
T4COD200007M	M	black
T4COD200007S	S	black
T4COD200007XL	XL	black
T4COD200007XXL	XXL	black

APPAREL

JERSEYS & SHIRTS





NEW



ARBARO JRS

ARBARO JRS is a cycling jersey dedicated to gravel enthusiasts. Its anatomically shaped sleeves are made from a delicate, openwork fabric, giving them a modern look. The ‚raw‘ finish in the Clean Cut technique adds character to the jersey. Top and bottom zipper garages prevent fabric damage. The covered zipper, with an auto-lock function, provides additional protection against the wind. Thanks to a carefully composed blend of polyester and elastane, the fabric quickly wicks moisture away, ensuring proper ventilation. The material has a UV blocker +50, which provides 98% protection against UV rays. The three-part back pocket is finished with a special tape to prevent items from sliding out. On the right side of the rear pocket, there is a hidden additional zippered pocket

MATERIAL	Polyester, elastane
SIZES	S, M, L, XL, XXL
ADDITIONAL INFORMATION	<p>High quality preventing from sunlight fabric with UV Blocker rating of +50</p> <p>Excellent ventilation and moisture-wicking</p> <p>Three-part pocket on the back with a tape closure to prevent items from slipping out</p> <p>Additional zippered pocket located in the central part of the rear pocket</p> <p>Sleeves made from openwork fabric, finished ‚raw‘ in the Clean Cut technique</p> <p>Reflective print on the back for added safety</p> <p>Invisible YKK zip with auto-lock function</p> <p>Zip guards at the top and bottom of the T-shirt to avoid chafing</p> <p>Made in Poland</p>

T4COD100035LBE	L	beige
T4COD100035MBE	M	beige
T4COD100035SBE	S	beige
T4COD100035XLBE	XL	beige
T4COD100035XXLBE	XXL	beige
T4COD100035LBK	L	black
T4COD100035MBK	M	black
T4COD100035SBK	S	black
T4COD100035XLBK	XL	black
T4COD100035XXLBK	XXL	black
T4COD100035LBL	L	blue
T4COD100035MBL	M	blue
T4COD100035SBL	S	blue
T4COD100035XLBL	XL	blue
T4COD100035XXLBL	XXL	blue



NEW



VOJAGO JRS

VOJAGO JRS is a cycling jersey perfect for GRAVEL bike enthusiasts. It's made from a blend of technical fabrics, including polyester and elastane, ensuring comfort and durability. The material is equipped with a UV blocker +50, providing 98% protection against UVB radiation. The back of the jersey is made of openwork fabric, allowing for rapid moisture wicking. The sleeves are laser-cut for and finished with silicone grip to prevent them from slipping. On the back of the jersey, there is a three-part pocket, reinforced with tape to prevent items from slipping out. Additionally, there is a zippered pocket in the middle of the rear pocket for added convenience.

MATERIAL	Polyester, elastane
SIZES	S, M, L, XL, XXL
ADDITIONAL INFORMATION	<p>High quality preventing from sunlight fabric with UV Blocker rating of +50</p> <p>Back of the jersey is made from an openwork fabric that allows for very rapid moisture wicking away from the body</p> <p>Three-part pocket on the back with a tape closure to prevent items from slipping out</p> <p>Additional zippered pocket located in the central part of the rear pocket</p> <p>Laser-cut sleeves are finished with a silicone grip to prevent them from riding up.</p> <p>Zip guards at the top and bottom of the T-shirt to avoid chafing</p> <p>Main zipper features an auto-lock function</p> <p>Made in Poland</p>

T4COD100034LBE	L	beige
T4COD100034LBL	L	blue
T4COD100034LGR	L	green
T4COD100034MBE	M	beige
T4COD100034MBL	M	blue
T4COD100034MGR	M	green
T4COD100034SBE	S	beige
T4COD100034SBL	S	blue
T4COD100034SGR	S	green
T4COD100034XLBE	XL	beige
T4COD100034XLBL	XL	blue
T4COD100034XLGR	XL	green
T4COD100034XXLBE	XXL	beige
T4COD100034XXLBL	XXL	blue
T4COD100034XXLGR	XXL	green



NEW



VETURO JRS

VETURO JRS is an excellent T-shirt designed for MTB bikes. Loose-fitting cut allows over-the-head wear and provides freedom of movement and gives an option to wear additional layers of clothes. It is made from 100% recycled polyester fabric, providing durability and comfort. Additional ventilation panels on the back ensure excellent breathability. Longer 3/4 sleeves reaching below the elbow add extra protection. A reflective element on the back enhances visibility. A waterproof zipper pocket is discreetly hidden in the right side seam.

MATERIAL	Upcycled Polyester
SIZES	S, M, L, XL, XXL
ADDITIONAL INFORMATION	<p>High quality fabric 100% Upcycled polyester</p> <p>Ventilation panels on the back provide excellent temperature control</p> <p>Waterproof pocket on the seam of back panel with a guided zip for easy zipping</p> <p>Reflective print on the back for added safety</p> <p>Made in Poland</p>

T4COD100033L	L	green
T4COD100033M	M	green
T4COD100033S	S	green
T4COD100033XL	XL	green
T4COD100033XXL	XXL	green



NEW



FORET JRS

FORET JRS is a T-shirt for MTB cycling enthusiasts. Its loose-fitting cut enables easy over-the-head wear. It is made from a lightweight polyester fabric known for its moisture-wicking properties, allowing moisture to evaporate easily. The fabric offers a high level of UV protection, with a UV Blocker rating of +50, indicating its effectiveness as a sun filter. It blocks at least 98% of UVB (ultraviolet B) radiation, which is responsible for sunburn and can be harmful to the skin. Ventilation panels under the armpits further improve air circulation. The back panel offers a waterproof pocket with a guided zip for easy zipping. Extended 3/4 sleeves feature laser-cut precision trim.

MATERIAL	Polyester
SIZES	S, M, L, XL, XXL
ADDITIONAL INFORMATION	High quality preventing from sunlight fabric with UV Blocker rating of +50
	Underarm ventilation panels provide excellent temperature control
	Waterproof pocket on the seam of right back panel with a guided zip for easy zipping
	Made in Poland

T4COD100032LGY	L	grey / grey
T4COD100032LGYOR	L	grey / orange
T4COD100032MGY	M	grey / grey
T4COD100032MGYOR	M	grey / orange
T4COD100032SGY	S	grey / grey
T4COD100032SGYOR	S	grey / orange
T4COD100032XLGY	XL	grey / grey
T4COD100032XLGYOR	XL	grey / orange
T4COD100032XXLGY	XXL	grey / grey
T4COD100032XXLGYOR	XXL	grey / orange



NEW



GRUNDO JRS

Grundo JRS is a model dedicated to MTB riding enthusiasts. It is a loose-fitting T-shirt worn over the head. It has underarm ventilation panels for excellent breathability and ventilation. The right seam in the back of the T-shirt features a waterproof pocket with a convenient guided zip for easy zipping. This functional T-shirt not only provides comfort during activity, but also allows you to store small items during a workout or expedition.

MATERIAL	Polyester
SIZES	S, M, L, XL, XXL
ADDITIONAL INFORMATION	Underarm ventilation panels provide excellent temperature control
	Waterproof pocket on the seam of right back panel with a guided zip for easy zipping
	Made in Poland

T4COD100031LBK	L	black
T4COD100031LGR	L	green
T4COD100031MBK	M	black
T4COD100031MGR	M	green
T4COD100031SBK	S	black
T4COD100031SGR	S	green
T4COD100031XLBK	XL	black
T4COD100031XLGR	XL	green
T4COD100031XXLBK	XXL	black
T4COD100031XXLGR	XXL	green



NEW



FLOW LADY 2.0 JRS

FLOW FEMI LINE is an excellent choice for women passionate about cycling. It is made from a thin fabric, a blend of polyester and elastane. Both zipper ends are equipped with so-called garages, which effectively protect fabric from damage. The sleeves are finished with laser cutting and a silicone grip, adding an aesthetic touch. Additionally, the jersey features ventilation panels that provide good breathability and airflow. On the back panel, there are three pockets finished with elastic bands, ensuring secure storage of small items during rides.

MATERIAL	Polyester, elastane
SIZES	XS, S, M, L
ADDITIONAL INFORMATION	High-quality technical fabric
	Underarm ventilation panels provide excellent temperature control
	Three-part pocket on the back panel
	On the right back panel, there is an additional zippered pocket
	Sleeves finished with laser-cutting and a silicone grip.
	Zip guards at the top and bottom of the T-shirt to avoid chafing
	Reflective elements all around the waist
	Made in Poland

T4COD100036LBL	L	black
T4COD100036LVI	L	purple
T4COD100036MBL	M	black
T4COD100036MVI	M	purple
T4COD100036SBL	S	black
T4COD100036SVI	S	purple
T4COD100036XSBL	XS	black
T4COD100036XSVI	XS	purple



KROSS ORLEN CYCLING TEAM REPLICA

The KROSS ORLEN Cycling Team jersey, adorned with graphics inspired by our team's official attire, has been crafted from Cooltech fabric. This advanced material effectively wicks moisture away, ensuring unparalleled comfort throughout our entire ride. The side panels and sleeves are made from the exceptional Lycra Full Moon fabric, not only improving air circulation but also enhancing riding comfort and shielding against excessive perspiration. Its elastic cut ensures a perfect fit for cyclists of various body types. Furthermore, three practical pockets on the back enable the carriage of essential accessories, which you always keep with you during our training sessions and races

MATERIAL	Polyester
SIZES	S, M, XL
ADDITIONAL INFORMATION	<ul style="list-style-type: none"> Full-length zipper Silicone gripper at the bottom of the jersey Three open pockets at the back Sleeve finished with a roll-up cuff Made in Poland

T4COD100024S	S	red
T4COD100024M	M	red
T4COD100024XXL	XXL	red



KROSS ORLEN CYCLING TEAM REPLICA

The replica of women's cycling jersey from KROSS ORLEN Cycling Team, adorned with graphics inspired by team's official attire, has been meticulously crafted from Cooltech fabric. This advanced material efficiently wicks moisture away, ensuring unadulterated comfort throughout your entire ride. Specially designed panels and sleeves, made from the unique Lycra Full Moon fabric, not only enhance air circulation but also elevate riding comfort, shielding you from excessive perspiration. Its elastic design guarantees a perfect fit for individuals of various body types. Furthermore, three practical back pockets allow you to carry essential accessories, always within easy reach during our training sessions and races

MATERIAL	Polyester
SIZES	S, M, L, XL
ADDITIONAL INFORMATION	<ul style="list-style-type: none"> Full-length zipper Silicone gripper at the bottom of the jersey Three open pockets at the back Sleeve finished with a roll-up cuff Made in Poland

T4COD100025XS	XS	red
T4COD100025S	S	red
T4COD100025M	M	red
T4COD100025L	L	red



PAVE

A slim fit with laser-finished sleeves further increase the comfort during cycling. Even the most demanding cyclists will love it for the light weight, excellent ventilation, slim fit and its nice-to-touch fabric. The additional back pockets will hold all the essentials, eliminating the need for a backpack or a frame bag.

MATERIAL	Polyester, Elastane
SIZES	S, M, L, XL
ADDITIONAL INFORMATION	<ul style="list-style-type: none"> Full-length zipper Silicone gripper at the bottom of the jersey Three pockets at the back Sleeves with a laser-cut finish Made in Poland

T4COD100023SBK	S	black
T4COD100023MBK	M	black
T4COD100023LBK	L	black
T4COD100023XLBK	XL	black
T4COD100023SRD	S	red
T4COD100023MRD	M	red
T4COD100023LRD	L	red
T4COD100023XLRD	XL	red
T4COD100023SDBL	S	blue
T4COD100023MDBL	M	blue
T4COD100023LDBL	L	blue
T4COD100023XLDL	XL	blue



HYDE KRT REPLICA

The HYDE cycling jersey is designed for all types of MTB. A great companion both for winding paths and dynamic downhill sections of enduro or dh competitions. Made of a breathable fabric that wicks sweat efficiently. Designed in collaboration with enduro riders, it can be used with protective equipment, while the elongated back protects you from mud. The jersey features a pocket with a goggle cleaning cloth, that can also hold a music player – handy when you're using a lift.

MATERIAL	Polyester
SIZES	S, M, L, XL
ADDITIONAL INFORMATION	High-quality breathable technical fabric Loose fit, extended 3/4-length sleeves Underarm ventilation panels provide excellent temperature control In the right side seam, there is a zip pocket containing a cloth for cleaning glasses Made in Poland

T4COD100014SRD	S	red
T4COD100014MRD	M	red
T4COD100014LRD	L	red
T4COD100014XLRD	XL	red



HYDE LONG SLEEVE

An all-purpose long-sleeve jersey for MTB cycling and more. The design is based on a classic 'long-sleeve', with some adjustments made with the most demanding cyclists in mind. The thin, breathable fabric adjust to your body movements, without restricting them in any way. Additional ventilation panels help to ensure optimal ventilation on hot days.

MATERIAL	Poliester, Elastane
SIZES	S, M, L, XL
ADDITIONAL INFORMATION	High-quality breathable technical fabric Loose fit, classic long sleeves Underarm ventilation panels provide excellent temperature control In the right side seam, there is a zip pocket containing a cloth for cleaning glasses Made in Poland

T4COD100016SRD	S	red
T4COD100016MRD	M	red
T4COD100016LRD	L	red
T4COD100016XLRD	XL	red
T4COD100016SGY	S	grey
T4COD100016MGY	M	grey
T4COD100016LGY	L	grey
T4COD100016XLY	XL	grey
T4COD100016SBKRD	S	black / red
T4COD100016MBKRD	M	black / red
T4COD100016LBKRD	L	black / red
T4COD100016XBKRD	XL	black / red



HYDE SHORT SLEEVE

An all-purpose short-sleeve jersey for MTB cycling and more. The design is based on a classic T-shirt, with some adjustments made with the most demanding cyclists in mind. The breathable fabric will prove itself even on the hottest days, offering optimal ventilation.

MATERIAL	Poliester, Elastane
SIZES	S, M, L, XL
ADDITIONAL INFORMATION	High-quality breathable technical fabric Loose fit, short sleeves Underarm ventilation panels provide excellent temperature control In the right side seam, there is a zip pocket containing a cloth for cleaning glasses Made in Poland

T4COD100017SBL	S	blue
T4COD100017MBL	M	blue
T4COD100017XLBL	XL	blue
T4COD100017MRD	M	red
T4COD100017LRD	L	red
T4COD100017XLRD	XL	red
T4COD100017SGY	S	grey
T4COD100017MGY	M	grey
T4COD100017LGY	L	grey
T4COD100017XLY	XL	grey

APPAREL

SHORTS





NEW 

ARBARO BIB

ARBARO BIB are ultralight shorts that provide exceptional comfort during off-road rides. They are made from specialized embossed fabric – a blend of polyamide and lycra with compression properties. The shorts have breathable panels on the back. They are equipped with suspenders made using laser-cutting technique, seamless front, and perforated silicone bands. The shorts' legs are laser-cut, seamless, and finished with a 5 cm silicone grip to prevent them from riding up. Using SKYVING technology, the fully seamless 4L TMF insert is designed for long-distance riding, ensuring comfort during extended journeys. On the back, under the suspender clips, there are two pockets for a tracker. Two perforated pockets on the sides of the legs allow for carrying energy bars and other small items

MATERIAL	Polyamid, Lycra Easy Rider
CHAMOIS	Antibacterial, anatomical shape, TMF 4L seamless, up to 5 hours
SIZES	S, M, L, XL, XXL
ADDITIONAL INFORMATION	<ul style="list-style-type: none"> Ultramodern perforated, antibacterial fabric with compression properties Seamless, laser-cut suspenders On the back, under the suspender clips, there are two pockets for a tracker Breathable panels on the back Laser-cut legs finished with a 5 cm silicone grip Two perforated pockets on the sides of the legs Reflective elements enhancing safety Made in Poland

T4COD000492L	L	black
T4COD000492M	M	black
T4COD000492S	S	black
T4COD000492XL	XL	black
T4COD000492XXL	XXL	black



NEW 

VOJAGO BIB

VOJAGO BIB are shorts designed for comfortable gravel riding. They come equipped with suspenders made from tape to prevent the shorts from slipping down. The anatomic TMF 3D insert ensures full comfort even during rides lasting over 4 hours. The shorts feature breathable panels on the back, enhancing air circulation. Reflective elements on the legs increase the cyclist's visibility. Perforated pockets on the sides of the shorts allow for storing energy gels or other small items. The shorts' legs are finished with a wide silicone grip tape, which stabilizes the shorts on the thigh

MATERIAL	Polyamid, Lycra Zaffiro
CHAMOIS	Antibacterial, anatomical shape, TMF 3D Long distance, up to 4 hours
SIZES	S, M, L, XL, XXL
ADDITIONAL INFORMATION	<ul style="list-style-type: none"> Ultra-modern antibacterial fabric Suspenders made from lightweight fabric that provides thermoregulation Breathable panels on the back External perforated pockets on the thighs Reflective elements for increased safety Legs finished with a wide silicone grip tape Made in Poland

T4COD000491L	L	black
T4COD000491M	M	black
T4COD000491S	S	black
T4COD000491XL	XL	black
T4COD000491XXL	XXL	black



NEW 

VETURO SHR

VETURO MTB Shorts - Excellent MTB riding shorts, providing comfort and functionality. Made from technical, hydrophobic, 4-way stretch fabric for full freedom of movement. The hydrophobic fabric protects against light rain by repelling water particles. There is a ventilation panel on the back of the shorts. Internal panels of the shorts have laser-cut holes to improve ventilation. There are two zippered pockets on the legs. The left pocket is made of openwork mesh, ideal for storing small items. The bottom of the shorts is finished with bonding technique for seamless construction. The waistband is fastened with snaps and has adjustable elements.

MATERIAL	Polyester, Elastane
SIZES	S, M, L, XL, XXL
ADDITIONAL INFORMATION	<ul style="list-style-type: none"> Top quality, light and very durable 4-way stretch technical fabric, repellent to water molecules Waist adjustment system: elastic & Velcro Waistband is fastened with snaps and features adjustable elements 2 zippered pockets on the front External mesh pocket on the right thigh Laser-cut vents at thigh height Bottom of the shorts is finished with a bonding technique for seamless construction Made in Poland

T4COD000490L	L	black
T4COD000490M	M	black
T4COD000490S	S	black
T4COD000490XL	XL	black
T4COD000490XXL	XXL	black



NEW



FORET 2.0 SHR

FORET SHR - excellent shorts for MTB riding. Made from technical fabric, ensuring durability and functionality. The waist can be precisely adjusted using an elastic band and Velcro. The shorts are fastened with a single snap and one hook. The zipper is directed from top to bottom for easier use. Laser-cut ventilation holes provide optimal air circulation. Additionally, there is an external mesh pocket on the left thigh, perfect for storing small items.

MATERIAL	Polyester, Elastane
SIZES	S, M, L, XL, XXL
ADDITIONAL INFORMATION	
	High-quality, light, and durable technical fabric
	Waist adjustment system: elastic & Velcro
	2 zipped pockets on the front
	Fastening: 1 press stud & 1 hook and eye
	External mesh pocket on the left thigh
	Reflective elements under the pockets
	Laser-cut vents at thigh height
	Made in Poland

T4COD000489LGY	L	grey
T4COD000489MGY	M	grey
T4COD000489SGY	S	grey
T4COD000489XLGY	XL	grey
T4COD000489XXLGY	XXL	grey



NEW



GRUNDO

GRUNDO - an excellent choice for MTB cyclists. Made from strong and durable polyester fabric, ensuring longevity for extended use. The shorts feature a snap closure waistband with adjustable elements. In the upper rear portion, there is an elastic panel that allows for better alignment of the shorts on the body during rides. There are zipper pockets on the legs, which can be opened from top to bottom, providing maximum convenience during rides. The left pocket is made of openwork mesh, ideal for storing small items.

MATERIAL	100% Polyester
SIZES	S, M, L, XL, XXL
ADDITIONAL INFORMATION	
	Durable technical fabric
	Waist adjustment system: elastic & Velcro
	2 zipped pockets on the front
	Fastening: 2 press studs
	External mesh pocket on the right thigh
	Ergonomic back panel
	Made in Poland

T4COD000488L	L	black
T4COD000488M	M	black
T4COD000488S	S	black
T4COD000488XL	XL	black
T4COD000488XXL	XXL	black



JEKYLL

Enduro cycling shorts. Made of 4-way stretchable fabric. Very lightweight and breathable: the mesh pocket lining additionally improves the air flow. Zipped side pockets will carry all your essential items. Detachable inner padding.

MATERIAL	Polyester, Nylon
CHAMOIS	Anatomical shape, 3D moisture wicking, up to 3 hours
SIZES	S, M, L, XL
ADDITIONAL INFORMATION	
	Lightweight and highly durable, a 4-way stretch technical fabric
	Waist adjustable system: Elastic band
	Shorts secured with a snap fastener 4 mesh pockets
	Detachable shorts with an antibacterial 3D chamois
	Designed in Poland

T4COD000284SBK	S	black
T4COD000284MBK	M	black
T4COD000284LBK	L	black
T4COD000284XLBK	XL	black
T4COD000293SDBL	S	dark blue
T4COD000293MDBL	M	dark blue
T4COD000293LDBL	L	dark blue
T4COD000293XLDL	XL	dark blue



LOGGER

These shorts are intended for XC and trail use. Made of 4-way stretchable fabric. Very lightweight and breathable: the mesh pocket lining additionally improves the air flow. Detachable inner padding.

MATERIAL	Polyester, Nylon
CHAMOIS	Anatomical shape, 3D moisture wicking, up to 3 hours
SIZES	S, M, L, XL
ADDITIONAL INFORMATION	Lightweight and highly durable, a 4-way stretch technical fabric Waist adjustable system: Elastic band Shorts secured with a snap fastener 2 pockets Detachable shorts with an antibacterial 3D cham Designed in Poland

T4COD000285SBK	S	black
T4COD000285MBK	M	black
T4COD000285LBK	L	black
T4COD000285XLBK	XL	black



FLOW LADY BIB 2.0

FLOW LADY 2.0 SHR is the perfect choice for women who prioritize comfort and performance during their rides. They are crafted from a fabric blend of polyamide and elastane, ensuring durability and flexibility. The suspenders are made from highly elastic openwork fabric and special perforated tape. The TMF 3D insert, designed with an anatomical shape, guarantees complete comfort even during rides lasting over 4 hours. The leg openings are finished with silicone grip tape, effectively preventing the legs from riding up during the ride. Additionally, reflective elements placed all around the shorts increase visibility, which is crucial for safety. The shorts also feature a comfortable and ergonomic waistband that ensures a proper fit and extra comfort during long rides.

MATERIAL	Polyamid, Elastane
CHAMOIS	Antibacterial, anatomical shape, TMF 3D Long distance, up to 4h
SIZES	XS, S, M, L
ADDITIONAL INFORMATION	Suspenders are made of highly elastic openwork fabric and perforated tape Leg finished with silicone grip tape Comfortable and ergonomic waistband Reflective elements all around the leg circumference Made in Poland

T4COD000498L	L	black / pink
T4COD000498M	M	black / pink
T4COD000498S	S	black / pink
T4COD000498XS	XS	black / pink



FLOW LADY 2.0 SHR

FLOW LADY 2.0 SHR – excellent women's shorts that provide exceptional comfort and convenience while cycling. They are made from a fabric blend of polyamide and elastane, ensuring durability and flexibility. The TMF 3D liner, designed with an anatomical shape, guarantees complete comfort even during rides lasting over 4 hours. The leg openings are finished with silicone grip tape, effectively preventing the legs from riding up during the ride. Additionally, reflective elements placed all around the shorts increase visibility, which is crucial for safety. The shorts also feature a comfortable and ergonomic waistband that ensures a proper fit and extra comfort during long rides.

MATERIAL	Polyamid, Elastane
CHAMOIS	Antibacterial, anatomical shape, TMF 3D Long distance, up to 4h
SIZES	XS, S, M, L
ADDITIONAL INFORMATION	Legs finished with silicone grip tape Laser-cut legs Comfortable and ergonomic waistband Reflective elements all around the leg circumference Made in Poland

T4COD000499L	L	black / pink
T4COD000499M	M	black / pink
T4COD000499S	S	black / pink
T4COD000499XS	XS	black / pink



FLOW LADY SHORTS

FLOW LADY SHORTS are designed with the comfort of lady cyclists in mind. The anatomical shape of the TMF 3D padding helps you to stay comfortable on the saddle for up to 5 h of cycling.

MATERIAL	Polyamide, Elastane
CHAMOIS	TMF 3D Long Distance, up to 5 hours of comfort
SIZES	XS, S, M, L
ADDITIONAL INFORMATION	Legs finished with silicone grip tape Comfortable, ergonomic waistband Made in Poland

T4COD000292XSBK	XS	black
T4COD000292SBK	S	black
T4COD000292MBK	M	black
T4COD000292LBK	L	black



SPORT 3/4

Women's cycling shorts with a convenient "3/4" length ensure comfort while cycling and the reflective elements increase safety. The padding prevents sores and lets you pedal comfortably.

MATERIAL	Polyamide, Elastane
CHAMOIS	TMF 3-L Long distance, up to 4 h
SIZES	S, M, L
ADDITIONAL INFORMATION	3/4-length leggings Comfortable, ergonomic waistband Made in Poland

T4COD000299S	S	black
T4COD000299M	M	black
T4COD000299L	L	black



KROSS ORLEN CYCLING TEAM REPLICA

Women' cycling bib shorts from KROSS ORLEN Cycling Team, adorned with graphics inspired by team's official attire. These shorts are equipped with a high-density Bormio chamois, allowing for comfortable hours in the saddle – ensuring comfort and protection even during 6-hour rides. The materials used in their construction effectively wick away sweat and provide proper ventilation. The leg ends are finished with mesh tape to prevent rolling up and uncomfortable chafing.

MATERIAL	Polyamide, Elastane
CHAMOIS	Performance Dolomiti Bormio, more than 6h
SIZES	XS, S, M, L
ADDITIONAL INFORMATION	Bibs made with tape in the front, and elastic mesh in the back Finished with a 4-centimeter-wide tape Chamois with multi-layer construction, featuring densities of 65 (kg/m3) and 120 (kg/m3), and an overall thickness of 16 mm Made in Poland

T4COD000296XS	XS	black
T4COD000296S	S	black
T4COD000296M	M	black
T4COD000296L	L	black



KROSS ORLEN CYCLING TEAM REPLICA

A replica of the men's KROSS ORLEN Cycling Team bib shorts. They are equipped with a high-density ergonomic chamois, designed to comfortably conquer more miles in the saddle, providing comfort and protection for up to 6 hours of riding. The materials used in their construction effectively wick away sweat and ensure proper ventilation. The leg ends are finished with mesh tape to prevent rolling up and uncomfortable chafing.

MATERIAL	Polyamide, Elastane
CHAMOIS	HD Ergonomic Man from La Fonte, up to 6h
SIZES	S, M, L, XL
ADDITIONAL INFORMATION	
	Bibs made with tape in the front, and elastic mesh in the back
	Legs finished with a 4-centimeter-wide tape
	Chamois with multi-layer construction, featuring densities of 120 (kg/m3), and an overall thickness of 16 mm
	Made in Poland

T4COD000295S	S	black
T4COD000295M	M	black
T4COD000295L	L	black
T4COD000295XL	XL	black
T4COD000295XXL	XXL	black



PRO LIGHT BIB

Ultra light PRO LIGHT bib shorts will meet the expectations of the most demanding cyclists. Top class padding ensures comfort even over long distances, while its ergonomic shape does not restrain your movements, improving your pedaling efficiency. Ventilation panels located in strategic places improve ventilation.

MATERIAL	Polyamide, Elastane
CHAMOISE	TMF 4D AIRMESH, up to 4 hours
SIZES	S, M, L, XL
ADDITIONAL INFORMATION	
	Front bibs made of tape, back made of elastic mesh
	Breathable panels on the back
	Made in Poland

T4COD000289SBK	S	black
T4COD000289MBK	M	black
T4COD000289LBK	L	black
T4COD000289XLBK	XL	black



PAVE BIB SHORTS

The PAVE bib shorts are perfect for those who value comfort and durable materials. The added Lycra evacuates sweat and ensures proper ventilation. The laser-finished legs improve aerodynamics and freedom of movements. High-quality padding will keep you comfortable even over long distances.

MATERIAL	Polyamide, Elastane
CHAMOIS	TMF 3D Long Distance, up to 4 hours
SIZES	S, M, L, XL
ADDITIONAL INFORMATION	
	Laser-finished leg ends
	Flat seams to prevent chafing
	Shorts composed of 3 panels of material, with varying proportions of Polyamide and Elastane
	Made in Poland

T4COD000291SBK	S	black
T4COD000291MBK	M	black
T4COD000291LBK	L	black
T4COD000291XLBK	XL	black
T4COD000291SBKBL	S	black / blue
T4COD000291MBKBL	M	black / blue
T4COD000291LBKBL	L	black / blue
T4COD000291XLBKBL	XL	black / blue



SPORT SHORT

The SPORT SHORT model is perfect for those who value comfort and durable materials. The added Lycra evacuates sweat and ensures proper ventilation. The laser-finished legs improve aerodynamics and freedom of movements. High-quality padding will keep you comfortable even over long distances.

MATERIAL	Polyamide, Elastane
CHAMOIS	TMF 2D Middle Distance, up to 3 hours
SIZES	S, M, L, XL
ADDITIONAL INFORMATION	
	Legs finished with silicone grip tape
	Comfortable, ergonomic waistband
	Made in Poland

T4COD000286SBK	S	black
T4COD000286MBK	M	black
T4COD000286LBK	L	black
T4COD000286XLBK	XL	black
T4COD000286SDBL	S	dark blue
T4COD000286MDBL	M	dark blue
T4COD000286LDBL	L	dark blue
T4COD000286XDBL	XL	dark blue



SPORT 3/4

Men's cycling 3/4 shorts ensure comfort while cycling and the reflective elements increase safety. The padding prevents sores and lets you pedal comfortably.

MATERIAL	Polyamide, Elastane
CHAMOIS	TMF 2D Middle Distance, up to 3 hours
SIZES	S, M, L, XXL
ADDITIONAL INFORMATION	
	Legs 3/4
	Comfortable, ergonomic waistband
	Made in Poland

T4COD000300S	S	black
T4COD000300M	M	black
T4COD000300L	L	black
T4COD000300XXL	XXL	black



PRO TEAM LONG 2.0

Long bib pants that satisfy the needs of the most demanding cyclists, designed for cycling in low temperatures and elevated humidity. Top-class padding ensures comfort even over long distances, while the right shape does not restrain your movements, improving your pedaling efficiency. The fabric used and the careful selection of spots where membrane is applied help to withstand the first rain impact and allow the pants to dry quickly. The perfect fit and foot stirrups improve aerodynamics and prevent wind from directly hitting your skin. Additional pocket on the straps will hold your phone and ID.

MATERIAL	Membrane, Elastane, 1st and 2nd panel: Polyamide, Elastane
PADDING	4D, quick-drying
SIZES	S, M, L, XL, XXL
ADDITIONAL INFORMATION	
	Legs finished with foot stirrups, a phone and ID pocket, wind-protective membrane
	Made in Poland

T4COD000305S	S	black
T4COD000305M	M	black
T4COD000305L	L	black
T4COD000305XL	XL	black
T4COD000305XXL	XXL	black



AIM WINTER 2.0

Long cycling bib pants for autumn and winter trainings. They will satisfy the needs of the most demanding cyclists: top-class padding ensures comfort even over long distances, while the right shape does not restrain your movements, improving your pedaling efficiency. The fabric used and the careful selection of spots where membrane is applied help to withstand rain impact and allow the pants to dry quickly. The perfect fit and foot stirrups improve aerodynamics and prevent wind from directly hitting your skin.

MATERIAL	1st panel: Polyester, Elastane
	2nd panel: Polyester
	3rd panel: Polyester, Elastane
UPPER PART	Polyamide, Elastane
PADDING	3D, quick-drying
SIZES	S, M, L, XL, XXL
ADDITIONAL INFORMATION	Made in Poland

T4COD000304S	S	black
T4COD000304M	M	black
T4COD000304L	L	black
T4COD000304XL	XL	black
T4COD000304XXL	XXL	black



APPAREL

UNDERWEAR





BASE TWO

A seamless cycling jersey. Ensures a close fit and wicks sweat efficiently. Special zones with higher breathability facilitate thermal regulation in the areas of increased perspiration during intense physical effort. Those zones were designed especially for cyclists, considering the bib strap or jersey zipper location. The additional anti-bacterial properties of the fibers improve the quality of use. This jersey ensures maximum thermal comfort with minimum weight.

MATERIAL	Polyamide, Polypropylene
SIZES	S/M, L/XL, XXL
ADDITIONAL INFORMATION	The fabric uses PROLEN® SILTEX special polypropylene yarn treated with a permanent antimicrobial additive, based on silver ions. PROLEN® SILTEX is effective against the growth of bacteria and reduces the activity of viruses, helping so to reduced unpleasant smells and keep hygienic freshness Made in Poland

T4COD00272SMBK	S/M	black
T4COD00272LXLBK	L/XL	black
T4COD00272XXLBK	XXL	black



BASE ONE

A seamless cycling jersey. Ensures a close fit and wicks sweat efficiently. Special zones with higher breathability facilitate thermal regulation in the areas of increased perspiration during intense physical effort. Those zones were designed especially for cyclists, considering the bib strap or jersey zipper location. The additional anti-bacterial properties of the fibers improve the quality of use. This jersey ensures maximum thermal comfort with minimum weight.

MATERIAL	Polyamide
SIZES	S/M, L/XL, XXL
ADDITIONAL INFORMATION	The production utilized a lightweight fabric manufactured by SENSIL® Breeze, which provides a cooling sensation, dryness, and comfort. Breeze helps maintain a comfortable body temperature during and after physical exertion and in hot weather. It offers protection against UV rays and facilitates optimal ventilation Made in Poland

T4COD00271SMWH	S/M	white
T4COD00271LXLWH	L/XL	white
T4COD00271XXLWH	XXL	white



BASE ZERO

A seamless cycling jersey. Ensures a close fit and wicks sweat efficiently. Special zones with higher breathability facilitate thermal regulation in the areas of increased perspiration during intense physical effort. Those zones were designed especially for cyclists, considering the bib strap or jersey zipper location. The additional anti-bacterial properties of the fibers improve the quality of use. This jersey ensures maximum thermal comfort with minimum weight.

MATERIAL	Polyamide
SIZES	S/M, L/XL, XXL
ADDITIONAL INFORMATION	The production utilized a lightweight fabric manufactured by SENSIL® Breeze, which provides a cooling sensation, dryness, and comfort. Breeze helps maintain a comfortable body temperature during and after physical performance and in hot weather. It offers protection against UV rays and facilitates optimal ventilation Made in Poland

T4COD00273LXLBK	L/XL	black
T4COD00273SMBK	S/M	black
T4COD00273XXLBK	XXL	black



BASE MAN

Underwear for the most demanding cyclists. Attractive design, innovative construction and perfect workmanship.

MATERIAL	Polyamide, Polyester
SIZES	S, M, L, XL, XXL
CHAMOIS	TMF 2D NEW MONO, up to 3 h
ADDITIONAL INFORMATION	Made in Poland

T4COD00276SBK	S	black
T4COD00276MBK	M	black
T4COD00276LBK	L	black
T4COD00276XLBK	XL	black
T4COD00276XXLBK	XXL	black



BASE LADY

Padded cycling underwear is a great way to transform your favorite pair of casual shorts into cycling apparel. Base lady can be used for any activity high in impact. These garments are base layers that are worn under your normal looking shorts or pants.

MATERIAL	Polyamide, Polyester
SIZES	S, M, L
CHAMOIS	TMF 2D NEW MONO, up to 3 h
ADDITIONAL INFORMATION	Made in Poland

T4COD00275SBK	S	black
T4COD00275MBK	M	black
T4COD00275LBK	L	black



SPORTBRA

Sports bra made of high-quality, breathable fabrics with silver ions. The special arrangement of the panels ensures sweat wicking also on warm days. A specially designed structure guarantees comfort both while cycling, jogging or practicing fitness.

MATERIAL	Polyamide (silver), Elastane
SIZES	XS, S, M, L
ADDITIONAL INFORMATION	Made in Poland

T4COD00274XSBK	XS	black
T4COD00274SBK	S	black
T4COD00274MBK	M	black
T4COD00274LBK	L	black
T4COD00274XSGY	XS	grey
T4COD00274SGY	S	grey
T4COD00274MGY	M	grey
T4COD00274LGY	L	grey

APPAREL

SOCKS





PRO HI

Socks made of a stretchable fabric that perfectly adjusts to the shape of your feet. The right alignment of fibers ensures proper ventilation during demanding uphill climbs and fast sprints.

MATERIAL	Cotton, Polyamide, Elastane
SIZES	S (36-38), M (39-41), L (42-44), XL (45-47)
ADDITIONAL INFORMATION	Made in Poland

T4COD000411SWH	S	white
T4COD000411MWH	M	white
T4COD000411LWH	L	white
T4COD000411XLWH	XL	white
T4COD000411SBL	S	blue
T4COD000411MBL	M	blue
T4COD000411LBL	L	blue
T4COD000411XLBL	XL	blue
T4COD000411SBK	S	red
T4COD000411MBK	M	red
T4COD000411LBK	L	red
T4COD000411XLBK	XL	red



STRADE

Classic socks, perfect for road cycling. Made of a stretchable fabric that perfectly adjusts to the shape of your feet. The right alignment of fibers ensures proper ventilation during demanding uphill climbs and fast sprints.

MATERIAL	Polypropylene
SIZES	S (36-38), M (39-41), L (42-44), XL (45-47)
ADDITIONAL INFORMATION	Made in Poland

T4COD000400SWH	S	white
T4COD000400MWH	M	white
T4COD000400LWH	L	white
T4COD000400XLWH	XL	white
T4COD000400SBK	S	black
T4COD000400MBK	M	black
T4COD000400LBK	L	black
T4COD000400XLBK	XL	black



PAVE HI

High-quality socks that ensure a perfect fit and good breathability performance. Great for use during races, as well as everyday training sessions.

MATERIAL	Cotton, Polyamide, Elastane
SIZES	S (36-38), M (39-41), L (42-44), XL (45-47)
ADDITIONAL INFORMATION	Made in Poland

T4COD000402SWH	S	white
T4COD000402MWH	M	white
T4COD000402LWH	L	white
T4COD000402XLWH	XL	white
T4COD000402SBK	S	blue-green
T4COD000402MBK	M	blue-green
T4COD000402LBK	L	blue-green
T4COD000402XLBK	XL	blue-green
T4COD000402SRD	S	black / red
T4COD000402MRD	M	black / red
T4COD000402LRD	L	black / red
T4COD000402XLRD	XL	black / red



PAVE MID

High-quality socks that ensure a perfect fit and good breathability performance. Great for use during races, as well as everyday training sessions.

MATERIAL	Cotton, Polyamide, Elastane
SIZES	S (36-38), M (39-41), L (42-44), XL (45-47)
ADDITIONAL INFORMATION	Made in Poland

T4COD000401SWH	S	white
T4COD000401MWH	M	white
T4COD000401LWH	L	white
T4COD000401XLWH	XL	white
T4COD000401SRD	S	black / red
T4COD000401MRD	M	black / red
T4COD000401LRD	L	black / red
T4COD000401XLRD	XL	black / red



LOONY HI

The LOONY socks are a marriage of comfort and durability. The materials used provide comfort during all-day rides, a special finish on the foot panel increases comfort even when you need to push your bike all the way to the top. For added confidence during dynamic downhill rides or the steepest uphill climbs.

MATERIAL	Cotton, Polyamide, Polypropylene, Elastane
SIZES	S (36-38), M (39-41), L (42-44), XL (45-47)
ADDITIONAL INFORMATION	Made in Poland

T4COD000403SGYBK	S	green / black
T4COD000403MGYBK	M	green / black
T4COD000403LGYBK	L	green / black
T4COD000403XLGYBK	XL	green / black
T4COD000403SRDBK	S	red / black
T4COD000403MRDBK	M	red / black
T4COD000403LRDBK	L	red / black
T4COD000403XLRDBK	XL	red / black



LOONY MID

The LOONY socks are a marriage of comfort and durability. The materials used provide comfort during all-day rides, a special finish on the foot panel increases comfort even when you need to push your bike all the way to the top. For added confidence during dynamic downhill rides or the steepest uphill climbs.

MATERIAL	Cotton, Polyamide, Polypropylene, Elastane
SIZES	S (36-38), M (39-41), L (42-44), XL (45-47)
ADDITIONAL INFORMATION	Made in Poland

T4COD000404SGYBK	S	green / black
T4COD000404MGYBK	M	green / black
T4COD000404LGYBK	L	green / black
T4COD000404XLGYBK	XL	green / black
T4COD000404SRDBK	S	red / black
T4COD000404MRDBK	M	red / black
T4COD000404LRDBK	L	red / black
T4COD000404XLRDBK	XL	red / black



RUBBLE MID

High-quality socks that ensure a perfect fit and good breathability performance. Excellent for use during races, as well as training sessions.

MATERIAL	Cotton, Polyamide, Elastane
SIZES	S (36-38), M (39-41), L (42-44), XL (45-47)
ADDITIONAL INFORMATION	Made in Poland

T4COD000405SBKRD	S	black / orange
T4COD000405MBKRD	M	black / orange
T4COD000405LBKRD	L	black / orange
T4COD000405XLBKRD	XL	black / orange
T4COD000405SBL	S	blue / red
T4COD000405MBL	M	blue / red
T4COD000405LBL	L	blue / red
T4COD000405XLBL	XL	blue / red



RUBBLE LOW

High-quality socks that ensure a perfect fit and good breathability performance. Excellent for use during races, as well as training sessions.

MATERIAL	Cotton, Polyamide, Elastane
SIZES	S (36-38), M (39-41), L (42-44), XL (45-47)
ADDITIONAL INFORMATION	Made in Poland

T4COD000406SBKRD	S	black / orange
T4COD000406MBKRD	M	black / orange
T4COD000406XLBKRD	XL	black / orange
T4COD000406SBL	S	blue / red
T4COD000406MBL	M	blue / red
T4COD000406LBL	L	blue / red
T4COD000406XLBL	XL	blue / red



ACTIVE LADY MID

Comfortable socks made of a stretchable fabric that perfectly adjusts to the shape of your feet. Perfect for mountain trails, but also for leisure and urban rides.

MATERIAL	Cotton, Polyamide, Elastane
SIZES	S (36-38), M (39-41), L (42-44)
ADDITIONAL INFORMATION	Made in Poland

T4COD000407MPI	M	purple
T4COD000407LPI	L	purple
T4COD000407SLZ	S	lagoon blue
T4COD000407MLZ	M	lagoon blue



ACTIVE LADY LOW

Comfortable socks made of a stretchable fabric that perfectly adjusts to the shape of your feet. Perfect for mountain trails, but also for leisure and urban rides.

MATERIAL	Cotton, Polyamide, Elastane
SIZES	S (36-38), M (39-41), L (42-44)
ADDITIONAL INFORMATION	Made in Poland

T4COD000408SPI	S	purple
T4COD000408MPI	M	purple
T4COD000408LPI	L	purple
T4COD000408SLZ	S	lagoon blue
T4COD000408MLZ	M	lagoon blue
T4COD000408LLZ	L	lagoon blue



ACTIVE MAN MID

Comfortable socks made of a stretchable fabric that perfectly adjusts to the shape of your feet. Perfect for mountain trails, but also for leisure and urban rides.

MATERIAL	Cotton, Polyamide, Elastane
SIZES	S (36-38), M (39-41), L (42-44), XL (45-47)
ADDITIONAL INFORMATION	Made in Poland

T4COD000409SBL	S	black
T4COD000409MBL	M	black
T4COD000409LBL	L	black
T4COD000409XLBL	XL	black
T4COD000409SRD	S	red
T4COD000409MRD	M	red
T4COD000409LRD	L	red
T4COD000409XLRD	XL	red



ACTIVE MAN LOW

Comfortable socks made of a stretchable fabric that perfectly adjusts to the shape of your feet. Perfect for mountain trails, but also for leisure and urban rides.

MATERIAL	Cotton, Polyamide, Elastane
SIZES	S (36-38), M (39-41), L (42-44), XL (45-47)
ADDITIONAL INFORMATION	Made in Poland

T4COD000410SBL	S	black
T4COD000410MBL	M	black
T4COD000410LBL	L	black
T4COD000410XLBL	XL	black
T4COD000410SRD	S	red
T4COD000410MRD	M	red
T4COD000410LRD	L	red
T4COD000410XLRD	XL	red

APPAREL

SHOES





CYCLING SHOES FLR F-XX CARBON

The updated F-XX II sports a sleeker profile, features the elite R500 stiff carbon fiber outsole for maximum power transfer and a sculpted footbed with a supportive heel that aids to increase blood flow, reduce hot spots and ensure that every power watt goes directly into your pedal for maximum performance output. The seamless upper is formed from a single piece of lightweight microfiber, with 6 air mesh inserts across the toe box and side panels to create an even airflow around the shoe and provide excellent ventilation for the entire foot. Two independent Atop dials optimize closure in each of the critical foot zones. The upper dial secures the arch and forefoot, while the lower dial locks the ankle & heel, ensuring a snug fit and zero heel movement.

MATERIAL	Microfiber leather
PURPOSE	Road
WEIGHT	496 g
TYPE OF CLOSURE	Flat ATOP knob A-A14 REEL
SOLE	Carbon, stiffness 15
ADDITIONAL INFORMATION	Socks included, nylon interior, seamless top of the shoe

T4CBUT00FXXR41BK	41	black
T4CBUT00FXXR41WH	41	white
T4CBUT00FXXR42BK	42	black
T4CBUT00FXXR42WH	42	white
T4CBUT00FXXR43BK	43	black
T4CBUT00FXXR43WH	43	white
T4CBUT00FXXR44BK	44	black
T4CBUT00FXXR44WH	44	white
T4CBUT00FXXR45BK	45	black
T4CBUT00FXXR45WH	45	white
T4CBUT00FXXR46BK	46	black
T4CBUT00FXXR46WH	46	white



CYCLING SHOES FLR F-11

Elegant, aerodynamic and comfortable, the pro-inspired F-11 shoes feature the perfect blend of performance, stiffness and support on the road. The F-11 uses a seamless upper design with our new pro-last, comprised from a single piece of premium microfiber to conform to the shape of your foot. The lacing system uses a single dial & velcro strap for a secure fit at each point of your foot. A combination of nylon mesh ports, perforated holes and a breathable tongue deliver excellent ventilation. The F-11 is equipped with the R250 outsole to boost performance and pedal power transfer without compromising on weight or comfort. Performance-driven with a pro-design, the F-11 will satisfy any rider looking for their next favorite pair of shoes.

MATERIAL	Microfiber leather
PURPOSE	Road
WEIGHT	541 g
TYPE OF CLOSURE	Knob and velcro
SOLE	Nylon, stiffness 7
ADDITIONAL INFORMATION	Breathable EVA sockliner

T4CBUT00F11R41BK	41	black
T4CBUT00F11R41WH	41	white
T4CBUT00F11R42BK	42	black
T4CBUT00F11R42WH	42	white
T4CBUT00F11R43BK	43	black
T4CBUT00F11R43WH	43	white
T4CBUT00F11R44BK	44	black
T4CBUT00F11R44WH	44	white
T4CBUT00F11R45BK	45	black
T4CBUT00F11R45WH	45	white
T4CBUT00F11R46BK	46	black
T4CBUT00F11R46WH	46	white



CYCLING SHOES FLR F-15

The shoe is designed with a three point closure system: a ratchet buckle to ensure a precise fit & secure closure and two offset velcro straps. The mid-foot strap conforms to your foot's shape for a 'second skin' feel and the additional strap aids in distributing pressure without pinching. The buckle and strap can be replaced. Featuring the R250 outsole designed with a full-length arch support that won't pack out over time; a well padded tongue that evenly distributes pressure; 2 layer composite footbed that absorbs road shock and nylon mesh ports for ventilation that all come together to make the F-15 III a supremely comfortable performance road shoe.

MATERIAL	Synthetic leather
PURPOSE	Road
WEIGHT	518 g
TYPE OF CLOSURE	Buckle + 2 velcros
SOLE	Nylon, stiffness 7
ADDITIONAL INFORMATION	Perforated tongue, double-layer insole

T4CBUT00F15R36BKPK	36	black / pink
T4CBUT00F15R37BKPK	37	black / pink
T4CBUT00F15R38BKPK	38	black / pink
T4CBUT00F15R39BKPK	39	black / pink
T4CBUT00F15R40BKPK	40	black / pink



ELITE PERF. INSOLE – LOW ARCH

Insoles with low padding. For universal use.

MATERIAL	Synthetic material
PURPOSE	Universal

T4CBUT0018R41LOW	40 - 41
T4CBUT0018R43LOW	42 - 43
T4CBUT0018R45LOW	44 - 45
T4CBUT0018R47LOW	46 - 47



ELITE PERF. INSOLE – MEDIUM ARCH

Insoles with medium padding. For universal use.

MATERIAL	Synthetic material
PURPOSE	Universal

T4CBUT0019R41MID	40 - 41
T4CBUT0019R43MID	42 - 43
T4CBUT0019R45MID	44 - 45
T4CBUT0019R47MID	46 - 47



ELITE PERF. INSOLE – HIGH ARCH

Insoles with high padding. For universal use.

MATERIAL	Synthetic material
PURPOSE	Universal

T4CBUT0020R41HI	40 - 41
T4CBUT0020R43HI	42 - 43
T4CBUT0020R45HI	44 - 45
T4CBUT0020R47HI	46 - 47



REEL KNOB FLR A-A42 70 CM

A-A42 Reel Knob - for Knit including lace 70 cm, 1pc (For F-XX / F-11 / F-70 Knit)

MATERIAL	Synthetic material
PURPOSE	Universal
LENGTH	70 cm

T4CBUT0021R70BK	70 cm	black
T4CBUT0021R70WH	70 cm	white



REEL KNOB FLR A-A42 55 CM

A-A42 Reel Knob including lace 55 cm, 1pc (For F-XX middle reel, F-22, F-11, F-75, F-70)

MATERIAL	Synthetic material
PURPOSE	Universal
LENGTH	55 cm

T4CBUT0022R55BK	55 cm	black
T4CBUT0022R55WH	55 cm	white



BLIZZARD

Overshoes made of a waterproof fabric. A reinforced layer provides abrasion resistance. The overshoes prevent your shoes from soaking and serve as a mud barrier. The zipper location prevents it from rubbing against the Achilles tendon. Additional reflective elements improve visibility on the road in difficult weather conditions.

MATERIAL	Neoprene, PVC
SIZES	S (36-38), M (39-41), L (42-44), XL (45-47)

T4COD100276S	S	black
T4COD100276M	M	black
T4COD100276L	L	black
T4COD100276XL	XL	black



SKIN

Overshoes made of a waterproof fabric. A reinforced layer provides abrasion resistance. The overshoes prevent your shoes from soaking and serve as a mud barrier. The zipper location prevents it from rubbing against the Achilles tendon. Additional reflective elements improve visibility on the road in difficult weather conditions.

MATERIAL	Nylon, Spandex
SIZES	S (36-38), M (39-41), L (42-44), XL (45-47)

T4COD100277S	S	black
T4COD100277M	M	black
T4COD100277L	L	black
T4COD100277XL	XL	black



LYCRA

Overshoes made of a waterproof fabric. A reinforced layer provides abrasion resistance. The overshoes prevent your shoes from soaking and serve as a mud barrier. The zipper location prevents it from rubbing against the Achilles tendon. Additional reflective elements improve visibility on the road in difficult weather conditions.

MATERIAL	Nylon, Spandex
SIZES	S (36-38), M (39-41), L (42-44), XL (45-47)

T4COD100278L	S	black
T4COD100278M	M	black
T4COD100278S	L	black
T4COD100278XL	XL	black



TOE COVER

Toe covers made of neoprene. A great "emergency" protection from the wind for your toes.

MATERIAL	Nylon, Neoprene, Polyester, PVC
SIZES	S/M (36-41), L/XL (42-47)

T4COD100279SM	S/M	fluo
T4COD100279LXL	L/XL	fluo



ACCESSORIES

BACKPACKS | BAGS & PANNIERS | BICYCLE COMPUTERS
LIGHTING | BOTTLES & BOTTLE CAGES | TOOLS | PUMPS | LOCKS
BELLS | CHILD SEATS & TRAILERS | CAR BIKE RACKS

ACCESSORIES

BACKPACKS





NEW

LOFTY

A functional backpack especially for those who want to take all the most necessary accessories, clothing, and a bladder on the trail. With a 12l capacity, it is suitable for day-long trips. The backpack is made from abrasion-resistant 420D Ripstop nylon and features durable YKK zips. The material is also waterproof, keeping the inside of the bag dry. The external pocket allows you to store your glasses or mobile phone. Special carrying systems enable helmet transportation. Specially designed perforated foam panels improve back ventilation, ensuring comfort even on hot days.

MATERIAL	420D Ripstop Nylon, 600D Polyester
ZIPPERS	YKK
CAPACITY	12 L
ADDITIONAL INFORMATION	
	Waterproof cover
	Reflective elements
	Ventilated straps
	Adjustable chest strap
	Hip belt with pockets
	Glasses / phone pocket
	Inner mesh pocket
	Retractable helmet holder
	Compartment for a 2-litre bladder

T4CTO000062



TOTAL 20 L

A functional backpack for those who want to carry all their essentials, clothes and bottles. Its size makes it a perfect companion even for a few days' trips. Made of abrasion-resistant Ripstop nylon, with durable YKK zippers. The material can withstand rain, keeping your items dry all the way to your destination. The side pocket will hold a mobile phone or a tablet. The inner pocket can be used for carrying goggles or a mobile phone. Special solutions enable you to carry a helmet. The waistband features side zipped pockets. Specially designed panels of perforated foam improve back ventilation, providing comfort even on hot days.

MATERIAL	Ripstop Nylon, 600D Polyester
ZIPPERS	YKK
CAPACITY	20 L
ADDITIONAL INFORMATION	
	1.5 L / 2 L bottle pocket
	Zippered side pocket for a phone/tablet
	Foldable integrated helmet holders
	Integrated waterproof cover
	Reflective prints
	Ventilated straps
	Back ventilation system
	Zippered inner pocket in the main compartment
	Goggle / phone pocket
	Waistband with zippered side pockets
	Inner pocket / organizer
	Adjustable chest strap

T4CTO000051



TOTAL 15 L

A functional backpack for those who want to carry all their essentials, clothes and bottles. Its size makes it a perfect companion even for all-day long trips. Made of abrasion-resistant Ripstop nylon, with durable YKK zippers. The material can withstand rain, keeping your items dry all the way to your destination. The inner pocket can be used for carrying goggles or a mobile phone. Special solutions enable you to carry a helmet. Specially designed panels of perforated foam improve back ventilation, providing comfort even on hot days.

MATERIAL	Ripstop Nylon
ZIPPERS	YKK
CAPACITY	15 L
ADDITIONAL INFORMATION	
	1.5 L / 2 L bottle pocket
	Foldable integrated helmet holders
	Integrated waterproof cover
	Reflective prints
	Ventilated straps
	Back ventilation system
	Goggle / phone pocket
	Inner pocket / organizer
	Adjustable chest strap

T4CTO000050



CRAFTER 25 L

A functional backpack for those who want to carry all their essentials, clothes and bottles. Its size makes it a perfect companion even for a few days' trips. Made of abrasion-resistant Ripstop nylon, with durable YKK zippers. The material can withstand rain, keeping the inside dry all the way to your shelter. The outer pocket will hold a jacket. It is also perfect for transporting both traditional and modular helmets. A lamp holder and reflective print on the straps improve safety in limited visibility conditions. Specially designed panels of perforated sponge improve back ventilation, providing comfort even on hot days.

MATERIAL	Ripstop Nylon
ZIPPERS	YKK
CAPACITY	25 L
ADDITIONAL INFORMATION	
	Waterproof cover
	Reflective prints
	Breathable straps
	Waistband pockets
	Mesh pocket inside
	Pocket for pump
	Safety whistle

T4CT0000023



PICKUP 15 L

A functional backpack for those who want to carry all their essentials, clothes and bottles. A perfect companion for day-long bike trips. Made of abrasion-resistant Ripstop nylon, with durable YKK zippers. The material can withstand rain, keeping the inside dry all the way to your shelter. The outer pocket will hold a jacket or a sleeping bag. It is also perfect for transporting both traditional and modular helmets. A lamp holder and reflective print on the straps improve safety in limited visibility conditions. Specially designed panels of perforated sponge improve back ventilation, providing comfort even on hot days.

MATERIAL	Ripstop Nylon
ZIPPERS	YKK
CAPACITY	15 L
ADDITIONAL INFORMATION	
	Waterproof cover
	Reflective prints
	Breathable straps
	Waistband pockets
	Mesh pocket inside
	Pocket for pump
	Safety whistle

T4CT0000024

T4CT0000002



PICKUP 15L TOKYO EDITION

A functional backpack for those, who want to take along all the most necessary accessories, clothing and a hydration bladder. It is perfect for whole day bike trips. The backpack is made from abrasion resistant Nylon Ripstop and durable YKK zippers. The used material will also be great for rainy weather, allowing to reach shelter with a dry interior. External pocket enables to store a jacket or sleeping bag. It is also ideal for transporting both traditional and modular helmets. The fixing for the lamp and reflective print on the straps will improve safety during limited visibility. Specially designed panels made of perforated foam improve ventilation of the back, providing comfort even on hot days.

MATERIAL	Nylon Ripstop
ZIPPER	YKK
CAPACITY	15 L
ADDITIONAL INFORMATION	
	Waterproof case
	Reflective trimmings
	Breathable shoulder straps
	Pockets on the waist line
	Mesh pockets inside
	Pocket for pump
	S.O.S. whistle

T4CT0000026



DESERT 5 L

A lightweight and functional backpack for those who want to carry all their essentials, clothes and a hydration bladder. Great both for marathons and out-of-town trips. Made of abrasion-resistant Ripstop nylon, with durable YKK zippers. The material can withstand rain, keeping the inside dry all the way to your shelter. A lamp holder and reflective print on the straps improve safety in limited visibility conditions. Specially designed panels of perforated sponge improve back ventilation, providing comfort even on hot days.

MATERIAL	Ripstop Nylon
ZIPPERS	YKK
CAPACITY	5 L
ADDITIONAL INFORMATION	
	Reflective prints
	Breathable straps
	Mesh pocket inside
	Pocket for pump
	Safety whistle

T4CTO000025



NEW

THICK

Thick is a very well-designed and meticulously crafted backpack with a sleek silhouette. It is made from durable and waterproof material resistant to scratches and tears. The first, front compartment of the backpack is very flat, but well organised, providing ample space for essential items such as a notebook, a powerbank, a phone, pens, keys, books, newspapers or an umbrella. The second compartment opens all the way down for easy access to its entire contents. The back, third compartment, includes a laptop sleeve. The backpack features an external USB port, so there is no need to take out the powerbank to charge your phone or other portable devices. On the front of the backpack there is a handy pocket for a wallet or a phone. The back of the backpack is reinforced and lined with special foam, ensuring excellent protection against impact while providing a comfortable fit on the back. It also includes a sturdy strap, enabling secure attachment to the travel bag handle. Durable shoulder straps have an additional fastening, distributing the weight evenly across the shoulders and chest. The backpack has two handles (one on the side and one at the top), so it can be carried by hand like a bag (the straps are not retractable).

MATERIAL	OXFORD
ZIPPERS	SBS
CAPACITY	22 L
ADDITIONAL INFORMATION	
	Internal pocket with an organiser
	Adjustable chest strap
	2 carrying handles
	Reinforced backpack back
	Phone / tablet pocket
	Internal laptop sleeve
	External usb port

T4CTO000061





CURIOSITY 28 L

A modern courier bag made of a waterproof technical fabric finished with Camouflage coating. The material used will prove itself during rainy weather. The bag will hold everything you need for a day away from home. The main compartment features a modern rolltop closure and the front zippered pocket allows full access to the main compartment. The pockets on the right side let you store your mobile phone or tablet. The left-hand mesh pocket can hold a bottle or an umbrella. The internal padded pocket allows you to carry a computer or tablet. The adjustable chest strap makes it easy to find your perfect fit. The padded back and straps ensure better ventilation. Buckles on the front part allow you to attach additional accessories.

MATERIAL	Waterproof technical fabric
ZIPPER	High-quality inverted zipper
CAPACITY	28 L
ADDITIONAL INFORMATION	<ul style="list-style-type: none"> Reflective elements on the front for increased safety Adjustable chest strap with SOS whistle Strap for attaching a bicycle lamp Breathable shoulder strap Ergonomic location of the zipper

T4CTO000056



JOURNEY 30 L

A cycling backpack for those who want to commute in style. The backpack will hold everything you need for a day away from home. It is made of polyester and waterproof Nylon. The backpack features an additional, waterproof zipped pocket on the front, where you can store your essentials. The side pockets can hold your mobile phone or tablet, a water bottle or an umbrella. You can also stash your must-haves in the front pocket with a key ring and an organizer for a pencil and a notebook. The inner main compartment features a padded laptop pocket. The adjustable chest strap makes it easy to find your perfect fit. A padded panel makes the backpack more breathable and comfortable. The designer rolltop features side buckles to attach your necessary accessories.

MATERIAL	Polyester / Nylon
ZIPPER	High-quality inverted zipper
CAPACITY	30 L
ADDITIONAL INFORMATION	<ul style="list-style-type: none"> Features a waterproof nylon bottom that is easy to clean Reflective elements on the front for increased safety Adjustable chest strap with a reflective edge for increased safety Zipped main pocket makes it easier to take your items out Front buckles allow you to attach additional accessories

T4CTO000057



NEW

THIN

The Thin backpack stands out for its quality stitching and simplicity. It is made from durable and waterproof material. At the front of the backpack there is a handy pocket for items such as a wallet, a phone, or a notebook. The second compartment can accommodate books, shoes, or a tracksuit. The backpack features an external USB port, so there is no need to take out the powerbank to charge your phone or other portable devices. Sturdy straps are adjustable to ensure an optimal fit. The backpack has a handle at the top, so you can carry it in your hand like a bag.

MATERIAL	OXFORD
ZIPPER	SBS
CAPACITY	18 L
ADDITIONAL INFORMATION	<ul style="list-style-type: none"> External document pocket Adjustable chest strap Internal laptop sleeve External USB port

T4CTO000060

ACCESSORIES

BAGS & PANNIERS



ESKER

SADDLE BAG





NEW

ESKER SB PRO 2

The ESKER SB PRO 2 expedition seat bag is made from fully waterproof and lightweight material resistant to abrasion and tear. It has welded seams, creating a tight coating that makes it completely waterproof. The bag is attached to the saddle bars and the seatpost. The two-point fastening system, reinforced with Velcro straps, allows the bag to adhere tightly to the seatpost and the saddle, increasing stability and reducing side movements. It is designed to make full use of the free space under the saddle. The ESKER SB PRO 2 has one main pocket with a capacity of up to 7 litres, which will hold all your essential items, even during long journeys. Its low weight, stable mounting, and waterproof design ensure the safety of your belongings.

MATERIAL	420D TPU, Hypalon
CAPACITY	7 L
ATTACHMENT LOCATION	To the saddle bars and the seatpost
ATTACHMENT SYSTEM	Velcro
WATERPROOF CLASS	IPX6
DIMENSIONS	58 x 16.5 x 14 cm
WEIGHT	323 g

T4CTO000066



NEW

GRAVESKER

GRAVESKER is a waterproof and practical front pannier, perfectly suitable for bikepacking trips, with a classic tube shape, designed to be attached to the handlebars. Bikepacking trips require ergonomic, lightweight, and durable components for transporting all the necessary items. The GRAVESKER pannier is the perfect complement to the ESKER bag range. It is lightweight and capacious, and made from damage-resistant and waterproof 420D TPU composite fabric and Hypalon known for its resistance to chemicals, extreme temperatures, and ultraviolet light. The contents of the bag can be accessed via a roll-up sleeve that closes with a press stud. It is mounted on the handlebars by means of robust Velcro straps.

MATERIAL	420D TPU, Hypalon
CAPACITY	10 L
ATTACHMENT LOCATION	Handlebar
ATTACHMENT SYSTEM	A support system attached to the handlebars
WATERPROOF CLASS	IPX6
DIMENSIONS	39 x 18 x 18 cm
WEIGHT	310 g

T4CTO000063



NEW

ESKER FB PRO 2

ESKER FB PRO 2 is an expedition bag mounted on the bicycle frame. It is made from lightweight nylon and has welded seams to create a tight coating. It is equipped with rain-proof zips to ensure that your luggage stays dry even during prolonged rainfall. Depending on your preference, it can be securely attached with strong Velcro straps to the top and bottom frame tubes or to the top frame tube and the seat tube. Its design allows you to carry two water bottles in baskets attached to the frame. If you want to carry more items, its capacity can be increased by unzipping the bottom of the bag. As part of a bikepacking kit, it is useful for carrying heavier items, but works equally well when used on its own for everyday commuting.

MATERIAL	420D TPU, Hypalon
CAPACITY	3 L
ATTACHMENT LOCATION	The main triangle of the frame
ATTACHMENT SYSTEM	Velcro
WATERPROOF CLASS	IPX6
DIMENSIONS	36 x 14 x 6 cm
WEIGHT	178 g

T4CTO000068



NEW

ESKER TTB PRO 2

The ESKER TTB PRO 2 bag is made from fully waterproof, lightweight and abrasion- and tear-resistant material. It has welded seams, creating a tight coating that makes it completely waterproof. It is mounted to the top frame tube with two bolts. This mounting system is commonly used on gravel bikes and provides a perfect fit to the frame, increasing stability and reducing lateral movements. ESKER TTB PRO 2 provides a secure storage space for frequently used items on bicycles equipped with screw hooks on the top tube. You can easily fit energy bars, energy gels and other foodstuffs to provide you with energy during your ride.

MATERIAL	420D TPU, Hypalon
CAPACITY	0,7 L
ATTACHMENT LOCATION	To the top frame tube
ATTACHMENT SYSTEM	Bolts & Velcro
WATERPROOF CLASS	IPX3
DIMENSIONS	20 x 8.5 x 5 cm
WEIGHT	53 g

T4CTO000067



ESKER SADDLE BAG

An expedition under-saddle bag made of a waterproof fabric. Mounted to saddle rods and seatpost, which makes it very stable during cycling. Its size will make muddy rides a breeze. The main compartment that boost a 7 L capacity will hold all the essential items for every long trip. Light weight, stable attachment and waterproof structure will keep your luggage safe.

MATERIAL	Waterproof Nylon
CAPACITY	7 L
ATTACHMENT LOCATION	Saddle rods and seatpost
ATTACHMENT SYSTEM	Velcro
WATERPROOF CLASS	IPX5
DIMENSIONS	58 x 16.5 x 14 cm
WEIGHT	323 g

T4CTO000052



ESKER FRAME BAG

ESKER FRAME BAG TRAVEL is an expedition bag attached to bike frame. It will hold all your essential items for every adventure. Extra side pockets ensure there is room for everything. Its waterproof structure guarantees your peace of mind even in the harshest conditions. The main compartment is expandable.

MATERIAL	Waterproof Nylon
CAPACITY	3 L
ATTACHMENT LOCATION	Main frame triangle
ATTACHMENT SYSTEM	Velcro
WATERPROOF CLASS	IPX3
DIMENSIONS	36 x 14 x 6 cm
WEIGHT	178 g

T4CTO000054



ESKER TOP TUBE BAG

The bag is mounted on the upper frame segment and it blends perfectly with its shape. The three-point Velcro attachment system makes this compact accessory of 0.7 L capacity compatible with most frame types.

MATERIAL	600D Nylon PU PVC
CAPACITY	0.7 L
ATTACHMENT LOCATION	Upper frame
ATTACHMENT SYSTEM	Velcro
WATERPROOF CLASS	IPX6
DIMENSIONS	20 x 8.5 x 5 cm
WEIGHT	53 g

T4CTO000055



AQUA STOP REAR PANNIER BAG HANDLE 19.2 L

A 100% waterproof, all-purpose, rack-mounted pannier bag. Thanks to the semi-automatic attachment system that allows you to attach and remove the pannier with one hand, this product is a perfect companion for every traveler. The adjustable buckles and adapters allow to use it with every horizontal rack type with various bar diameters. The included carrying strap makes it easy to carry the bag after removing it from the bike.

MATERIAL	PVC
CAPACITY	19.2 L
ATTACHMENT LOCATION	Rack
ATTACHMENT SYSTEM	Buckles
WATERPROOF CLASS	IPX6
DIMENSIONS	40 x 32 x 15 cm
WEIGHT	1.12 kg

T4CTO000041



AQUA STOP REAR PANNIER BAG 25.4 L

A 100% waterproof, all-purpose, rack-mounted pannier bag. Thanks to the semi-automatic attachment system that allows you to attach and remove the pannier with one hand, this product is a perfect companion for every traveler. The adjustable buckles and adapters allow to use it with every horizontal rack type with various bar diameters.

MATERIAL	PVC
CAPACITY	16 L
ATTACHMENT LOCATION	Rack
ATTACHMENT SYSTEM	Buckles
WATERPROOF CLASS	IPX6
DIMENSIONS	26 x 13 x 47 cm
WEIGHT	600 g

T4CTO000040



AQUA STOP REAR PANNIER BAG 16 L

A 100% waterproof, all-purpose, rack-mounted pannier bag. Thanks to the semi-automatic attachment system that allows you to attach and remove the pannier with one hand, this product is a perfect companion for every traveler. The adjustable buckles and adapters allow to use it with every horizontal rack type with bars of up to 15 mm in diameter. The included carrying strap makes it easy to carry the bag after removing it from the bike.

MATERIAL	PVC
CAPACITY	16 L
ATTACHMENT LOCATION	Rack
ATTACHMENT SYSTEM	Buckles
WATERPROOF CLASS	IPX6
DIMENSIONS	26 x 13 x 47 cm
WEIGHT	600 g

T4CTO000039



AQUA STOP HANDLEBAR

A 100% waterproof, all-purpose, handlebar-mounted pannier bag. Durable Velcro straps help to fix it to any handlebars with no special adapters needed. The included carrying strap makes it easy to carry the bag after removing it from the handlebars.

MATERIAL	PVC
CAPACITY	9.5 L
ATTACHMENT LOCATION	Handlebars
ATTACHMENT SYSTEM	Velcro
WATERPROOF CLASS	IPX6
DIMENSIONS	26 x 14.5 x 25 cm
WEIGHT	310 g

T4CTO000037



AQUA STOP SADDLE BAG

A 100% waterproof under-saddle bag of 1.5 l capacity will help you to carry all the necessary tools, a wallet, phone and even a thin waterproof jacket, such as KROSS FLURRY. Features a folded edge for a completely waterproof main compartment closure. Mounting straps and durable Velcro straps help to attach it to any saddle and rigid seatstay.

MATERIAL	PVC
CAPACITY	1.5 L
ATTACHMENT LOCATION	Saddle rods and seatpost
ATTACHMENT SYSTEM	Velcro
WATERPROOF CLASS	IPX6
DIMENSIONS	20 x 10.5 x 7 cm
WEIGHT	155 g

T4CTO000038



AQUA STOP PHONE CASE

A 100% waterproof handlebar-mounted phone case with a special, removable adapter. The oval inner head of the adapter allows you to set the phone at the desired angle. The phone case can be removed from its bracket without any tools needed, which makes it a mobile, waterproof case you can carry wherever you want.

MATERIAL	PVC
ATTACHMENT LOCATION	Handlebars
ATTACHMENT SYSTEM	Bracket
WATERPROOF CLASS	IPX6
DIMENSIONS	20.9 x 10.5 cm
WEIGHT	76 g

T4CTO000036



NEW

TRAVELER 3.0

TRAVELER 3.0 is a high-quality rear pannier with three compartments, made from durable 900D tear-resistant material and waterproof PVC. The side panniers have large main compartments reinforced with internal stiffeners and one external pocket each. Depending on your needs, for longer trips or shopping for a few days, each pannier can be used separately. The side panniers are attached to the carrier holder by means of a QMS system, which ensures their stability and versatility to fit various types of carriers. The bags connect to each other through the Top Case, which is fitted with sturdy, easy-to-fit fasteners. The Top Case can be used separately as a bike backpack for city rides. The backpack has one main 40 l compartment and an additional 2 l compartment within it, as well as two zipped side pockets. Thanks to its waterproof material, the TRAVELER 3.0 three-compartment pannier ensures proper protection of any items inside.

MATERIAL	matte PVC, 900D
CAPACITY	42 L
ATTACHMENT LOCATION	To the carrier tubes
ATTACHMENT SYSTEM	QMS - Quick Mounting System
DIMENSIONS	35 x 32 x 14 cm (single pannier) 40 x 23 x 12 cm (top pannier)

T4CTO000065



NEW

TRAVELER 2.0

A set of two side panniers made from durable, tear-resistant PVC, 900D materials. Panniers reinforced with internal stiffeners. The waterproof material provides adequate protection for the items carried. The panniers have large main compartments and one side pocket each. Panniers are attached to the carrier using the QMS fastening system. Hook and strap mounting makes it suitable for all types of rear carriers.

MATERIAL	matte PVC, 900D
CAPACITY	30 l (2 x 15 l)
ATTACHMENT LOCATION	To the carrier tubes
ATTACHMENT SYSTEM	QMS - Quick Mounting System
DIMENSIONS	35 x 32 x 14 cm (single pannier)

T4CTO000064



ROAMER TRUNK BIG BAG CARRY MORE

The ROAMER TRUNK BIG BAG Carry More model is especially designed for the Carry More quick lock system used in KROSS racks. The system allows you to attach a bag quickly and firmly, and then release it with a touch of a button. The bag itself has an inside compartment that features a handy organizer with slash side pockets. With the pockets expanded, the bag reaches 27.4 L in capacity. Carrying strap included.

MATERIAL	600D Polyester
CAPACITY	16-27.4 L (with side pockets expanded)
ATTACHMENT LOCATION	Rack
ATTACHMENT SYSTEM	Carry More
COMPATIBILITY	KROSS TRAVELRACK CM, LIBERTY CM, WEEKENDRACK CM, EVATRANS CM S/L racks
DIMENSIONS	40 x 22 x 30 cm
WEIGHT	1.18 kg

T4CTO000035



ROAMER TRUNK BAG CARRY MORE

The ROAMER TRUNK BAG Carry More model is especially designed for the Carry More quick lock system used in KROSS racks. The system allows you to attach a bag quickly and firmly, and then release it with a touch of a button. The bag itself has one compartment that can be expanded by unzipping the side zipper to gain additional 3 L in capacity. Slash pockets are other advantages of this bag. With the pockets expanded, the bag reaches 21.6 L in capacity. Carrying strap included.

MATERIAL	600D Polyester
CAPACITY	7.6-21.6 L (with side pockets and main compartment expanded)
ATTACHMENT LOCATION	Rack
ATTACHMENT SYSTEM	Carry More
COMPATIBILITY	KROSS TRAVELRACK CM, LIBERTY CM, WEEKENDRACK CM, EVATRANS CM S/L racks
DIMENSIONS	33 x 15 x 26 cm
WEIGHT	1 kg

T4CTO000044



ROAMER TRUNK BAG

A handy bag that can be attached to the rack. Features high-quality inverted zippers. The sewn-in reflective straps and lamp holder increase safety in limited visibility conditions. Velcro closure for easy access to bag interior.

MATERIAL	600D Polyester
CAPACITY	11 L
ATTACHMENT LOCATION	Rack
ATTACHMENT SYSTEM	Velcro
DIMENSIONS	30.5 x 16.5 x 21 cm
WEIGHT	520 g

T4CTO000031



ROAMER TRIPLE REAR BAG

High-class rear triple-compartment panniers made of durable 600d Polyester. The top compartment features a mesh to which you can attach a large luggage. Stability is ensured by a system of internal stiffeners.

MATERIAL	600D Polyester
CAPACITY	20 L
ATTACHMENT LOCATION	Rack
ATTACHMENT SYSTEM	Straps
WEIGHT	850 g

T4CTO000029



ROAMER REAR BAG

High-quality double rear panniers made of durable nylon. Top flaps are closed with a buckle. Attached to the rack with durable Velcro straps.

MATERIAL	Nylon
CAPACITY	10 L
ATTACHMENT LOCATION	Rack
ATTACHMENT SYSTEM	Velcro
WEIGHT	660 g

T4CTO000030



ROAMER UNI PANNIERS

A high-class set of panniers made of durable nylon. Features an easy-to-use attachment system. Extra outer mesh pocket. Waterproof case included. The main compartment has a buckle closure. The bottom part is made of abrasion-resistant rubber.

MATERIAL	Nylon
CAPACITY	12 l (single pannier)
ATTACHMENT LOCATION	Front or rear rack
ATTACHMENT SYSTEM	Buckles
WEIGHT	720 g

T4CTO000028



ROAMER MAP BAG

A high-class bag attached to handlebars. The quick attachment system makes it easy to attach and remove the bag. The provided transparent foil enables you to use a map and two front pockets ensure convenient access to your essentials. The bag features reflective straps that increase your safety in limited visibility conditions.

MATERIAL	600D Polyester
CAPACITY	6 L
ATTACHMENT LOCATION	Handlebars
ATTACHMENT SYSTEM	Quick release mechanism
DIMENSIONS	20 x 12 x 25 cm
WEIGHT	430 g

T4CTO000045



ROAMER TOP BAG

A high-quality bag that can be attached to the top tube, for phones of up to 5.5" screen size and other essential accessories. Special protective screen enables you to use your phone without removing it from the case. Velcro closure system for easy access to bag interior. Features a high-quality inverted zipper.

MATERIAL	600D Polyester
CAPACITY	0.9 L
ATTACHMENT LOCATION	Top frame tube
ATTACHMENT SYSTEM	Velcro
DIMENSIONS	15 x 8 x 8 cm
WEIGHT	300 g

T4CTO000033



PHONE CASE

A high-quality phone case suitable for phones of up to 5.5" screen size, can be attached to handlebars. The quick mounting system does not require any tools. Features a high-quality inverted zipper. Special protective screen enables you to use your phone without removing it from the case.

MATERIAL	600D Polyester
ATTACHMENT LOCATION	Handlebars
ATTACHMENT SYSTEM	Quick release mechanism
DIMENSIONS	17 x 9.5 x 2 cm
WEIGHT	200 g

T4CTO000032



ROAMER SADDLE BAG L

A handy bag made of durable Ripstop Nylon. High-quality Velcro strap will secure all your essential accessories. Durable inverted zipper ensures reliable performance for many kilometers. Light holder increases safety in limited visibility conditions.

MATERIAL	Ripstop Nylon
CAPACITY	0.7 L
ATTACHMENT LOCATION	Saddle rods and seatpost
ATTACHMENT SYSTEM	Velcro, buckles
DIMENSIONS	16 x 8 x 6 cm
WEIGHT	100 g

T4CTO000034BK	black
T4CTO000034BL	blue
T4CTO000034LGY	grey



ROAMER SADDLE BAG S

A handy bag made of durable Ripstop Nylon. High-quality Velcro strap will secure all your essential accessories. Durable inverted zipper ensures reliable performance for many kilometers. Light holder increases safety in limited visibility conditions.

MATERIAL	Ripstop Nylon
CAPACITY	0.6 L
ATTACHMENT LOCATION	Saddle rods and seatpost
ATTACHMENT SYSTEM	Velcro, buckles
DIMENSIONS	14 x 8 x 6 cm
WEIGHT	80 g

T4CTO000048BK	black
T4CTO000048GY	grey
T4CTO000048GR	green



ROAMER TRIANGLE L

A very handy triangle bag for all your essentials. Equipped with durable zippers and high-quality Velcro straps, will hold all your bike trip essentials, as well as items handy for everyday use.

MATERIAL	600D Polyester
CAPACITY	1.3 L
ATTACHMENT LOCATION	Main frame triangle
ATTACHMENT SYSTEM	Velcro
DIMENSIONS	22.5 x 4.5 x 20 cm
WEIGHT	400 g

T4CTO000046



ROAMER TRIANGLE M

A very handy triangle bag for all your essentials. Equipped with durable zippers and high-quality Velcro straps, will hold all your bike trip essentials, as well as items handy for everyday use.

MATERIAL	600D Polyester
CAPACITY	0.9 L
ATTACHMENT LOCATION	Main frame triangle
ATTACHMENT SYSTEM	Velcro
DIMENSIONS	22 x 22 x 4 cm
WEIGHT	30 g

T4CTO000043



TRIANGLE BAG

A very handy triangle bag for all your essentials. Equipped with durable zippers and high-quality Velcro straps, will hold all your bike trip essentials, as well as items handy for everyday use.

MATERIAL	Ripstop Nylon
CAPACITY	1.2 L
ATTACHMENT LOCATION	Main frame triangle
ATTACHMENT SYSTEM	Velcro
DIMENSIONS	22 x 20 x 5.5 cm
WEIGHT	87 g

T4CTO000049BK black

T4CTO000049BL blue

T4CTO000049GY grey



ACCESSORIES

BICYCLE COMPUTERS



BICYCLE COMPUTER KRC 650

NAVI GPS MOC/CAD/HR



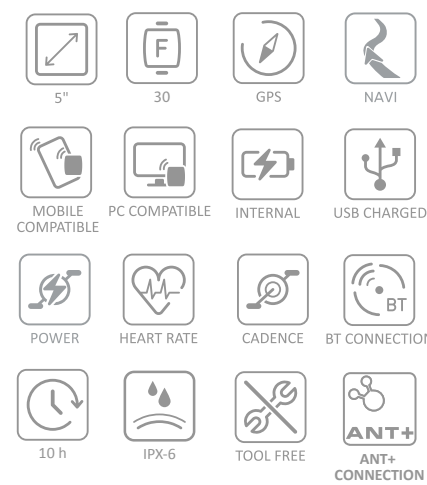

KRC 650 NAVI

A professional bicycle computer with a built-in GPS receiver will always get you to your destination. You can plan your route in the Ride for Life app and send it to the device. The navigation system will tell you when to take a turn, so that you can reach your destination. The computer features the BLE 4.0 and ANT+ technologies, which guarantees compatibility with heart rate, speed, power and cadence meters. The computer is equipped with a large and clear display. There is no need for other sensors to view the basic data, as they are read with the use of the GPS technology. The computer displays all the necessary data, such as trip, speed, cadence, heart rate, elevation differences, height and temperature. You can customize the data you see on the display. If you want to control the intensity of your training sessions, you can use the cadence, heart rate and power meters. Detailed information is collected during your ride, so that you can analyze it later on your computer or share in Strava™ or TrainingPeaks™. The durable and waterproof case of the KRC 650Navi allows to collect your data even in really harsh weather conditions. You can monitor the USB-charged battery level thanks to a clearly visible indicator. Always ready to turn on. Compatible sensors that support the BLE 4.0 / ANT+ technologies sold separately.

CYCLING FUNCTIONS

Current speed, Average speed, Max speed, Speed comparison to average speed, Odometer, Total distance, Current cadence, Average cadence, Max cadence

NAVIGATION

Turn by turn

ELEVATION FUNCTIONS

Current elevation, Average elevation, Max elevation, Max slope, Average slope

TIME FUNCTIONS

Clock, Trip time

POWER FUNCTIONS

Current power, Average power, Max power
FTP test

HEART RATE FUNCTIONS

Current heart rate, Average heart rate, Max heart rate

GENERAL FUNCTIONS

Display data customization, GPS signal strength indicator, BLE 4.0 Smart & ANT+, Thermometer, Battery and sensor level indicator, Saving data to internal storage, Button sound on/off, Data export to Smartphone APP

T4CLI000167

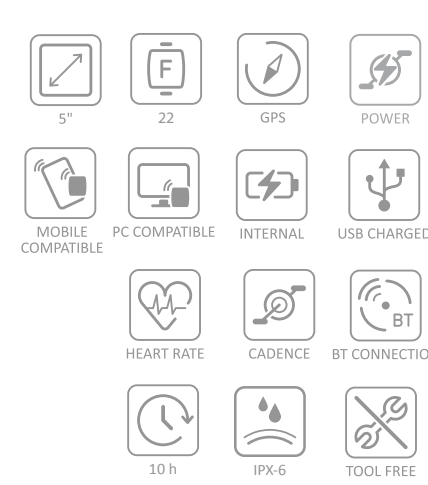

KRC 650 TRACK

The GPS technology eliminates the need to use speed sensors. The KRC 650 TRACK analyzes the satellite signal, displaying the current speed, the distance covered and the elevation differences. This advanced bicycle computer collects ride data, so that they can be sent to platforms such as Strava™ with the use of the Ride for Life app, available for download from Google Play. The KRC 650 TRACK can be paired with cadence, heart rate, and even power sensors. Power is one of the parameters that cyclists want to monitor nowadays. The KRC 650 TRACK model is specialized in power functions. Power is the only parameter that is not influenced by the wind that blows straight in your face or back, steep downhill rides or easy uphill climbs, it is the true measure of your effort. A power sensor allows you to measure your current power! Compatible sensors that support the BLE 4.0 technology sold separately.

CYCLING FUNCTIONS

Current speed
Average speed
Max speed
Speed comparison to average speed
Odometer
Total distance
Current cadence
Average cadence
Max cadence

ELEVATION FUNCTIONS

Current elevation
Max elevation
Current slope
Max slope
Average slope

TIME FUNCTIONS

Clock
Trip time

POWER FUNCTIONS

Current power
Average power

HEART RATE FUNCTIONS

Current heart rate
Average heart rate
Max heart rate

GENERAL FUNCTIONS

GPS signal strength indicator
BLE 4.0 Smart & ANT+
Thermometer
Battery level indicator
Saving data to internal storage
Button sound on/off
Data export to Smartphone APP

T4CLI000169



KRC 222CW

An advanced, USB-charged wireless bicycle computer with 22 functions. Cadence meter and average values are handy for those who want to monitor the intensity of their training sessions. The replacement wheel setting memory feature is particularly handy for users who frequently change their tires, using various widths. KRC222CW can also measure the total distance for two bicycles. The built-in calorie counter allows you to monitor calories burned. The battery charge indicator updates you on the battery level. The clear and backlit screen lets you conveniently use the computer at night.

CYCLING FUNCTIONS

Current speed
Average speed
Max speed
Speed comparison to average speed
Current cadence
Average cadence
Max cadence
Trip distance
Total distance
Week distance

TIME FUNCTIONS

Clock (12/24)
Riding time
Stopwatch
Weekly riding time

GENERAL FUNCTIONS

2 wheel dimension settings
Auto Scan
Auto ON/OFF
Backlight
Temperature
Metric / imperial units
Analog speedometer
Carbon footprint
Burned calorie counter

T4CLI000164



KRC 219UW

An advanced, USB-charged wireless bicycle computer with 19 functions. The replacement wheel setting memory feature is particularly handy for users who frequently change their tires, using various widths. KRC219UW can also measure the total distance for two wheel settings. The built-in thermometer allows you to analyze temperatures. The battery charge indicator updates you on the battery level. The clear and backlit screen lets you conveniently use the computer at night.

CYCLING FUNCTIONS

Current speed
Average speed
Max speed
Speed comparison to average speed
Trip distance
Total distance
Week distance

TIME FUNCTIONS

Clock (12/24)
Riding time
Stopwatch
Weekly riding time

GENERAL FUNCTIONS

2 wheel dimension settings
Auto Scan
Auto ON/OFF
Backlight
Temperature
Metric / imperial units
Analog speedometer
Carbon footprint
Burned calorie counter

T4CLI000163



KRC 211UW

A wireless, USB-charged bicycle computer with 11 functions will come in handy both during weekend trips and competitions. The computer is wirelessly connected to the sensor, eliminating the risk of a cable getting caught on a tree branch.

CYCLING FUNCTIONS

Current speed
Average speed
Max speed
Odometer
Total distance

TIME FUNCTIONS

Clock (12/24)
Training duration

GENERAL FUNCTIONS

Thermometer
Auto ON/OFF
Backlight
Metric / imperial units

T4CLI000162



KRC 211U

An easy-to-attach USB-charged bicycle computer with an ergonomic dashboard. Features a bright and clear display to conveniently read all available values. Equipped with 11 functions that come in handy both during weekend trips and cycling competitions.

CYCLING FUNCTIONS

Current speed
Average speed
Max speed
Odometer
Total distance

TIME FUNCTIONS

Clock (12/24)
Training duration

GENERAL FUNCTIONS

Thermometer
Auto ON/OFF
Backlight
Metric / imperial units

T4CLI000161



KRC 218

An advanced wired bicycle computer with 18 functions. The replacement wheel setting memory feature is particularly handy for users who frequently change their tires, using various widths. KRC 218 also features an odometer. The built-in thermometer allows you to analyze temperatures. The clear and backlit screen lets you conveniently use the computer at night.

FEATURE	Wired
CYCLING FUNCTIONS	
	Current speed
	Average speed
	Max speed
	Speed comparison to average speed
	Trip distance
	Total distance
	Week distance
TIME FUNCTIONS	
	Clock (12/24)
	Riding time
	Stopwatch
	Weekly riding time
GENERAL FUNCTIONS	
	2 wheel dimension settings
	Auto Scan
	Auto ON/OFF
	Backlight
	Temperature
	Metric / imperial units
	Menu available in 5 languages
	Analog speedometer
	Carbon footprint
	Burned calorie counter

T4CLI000155BKGY

black / grey



KRC 211

An easy-to-attach wired bicycle computer with an ergonomic dashboard. Features a bright and clear display to conveniently read all available values. Equipped with 11 functions that come in handy both during weekend trips and cycling competitions. The clear and backlit screen lets you conveniently use the computer at night.

FEATURE	Wired
CYCLING FUNCTIONS	
	Current speed
	Average speed
	Max speed
	Trip distance
	Total distance
TIME FUNCTIONS	
	Clock (12/24)
	Riding time
	Stopwatch
GENERAL FUNCTIONS	
	Auto Scan
	Auto ON/OFF
	Backlight
	Metric / imperial units

T4CLI000154BK

black



KRC 208

An easy-to-attach wired bicycle computer with 8 functions and a clear panel. Features a bright and clear display to conveniently read all available values. Has all the essentials that come in handy during every bike trip.

FEATURES	Wired
CYCLING FUNCTIONS	
	Current speed
	Average speed
	Max speed
	Odometer
	Total distance
	Scan
TIME FUNCTIONS	
	Clock (12/24)
	Training duration

T4CLI000160



CRANC CAD

CRANC CAD is a small and sleek device that measures your cadence. It is wireless, does not feature a magnet and it can be easily attached to the bicycle crank arm. The BLE 4.2 and ANT + technologies allow you to connect to and display data on compatible computers and smartphones.

ADDITIONAL INFORMATION

Precise cadence measurement
Compact and flat
Universal mounting bracket, can be easily attached to the crank mechanism
Equipped with the BLE 4.2 and ANT+ wireless transfer technologies
Compatible with most bicycle computers and smartphones without dedicated device locks

T4CLI000166

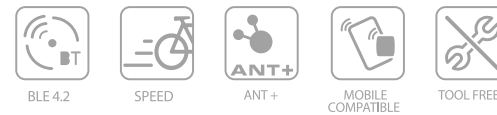

HUB SPEED SENSOR

HUB SPEED SENSOR is a modern device that captures speed data and is mounted to the front wheel hub. The BLE 4.2 and ANT + technologies allow you to connect to and display data on compatible computers and smartphones.

ADDITIONAL INFORMATION

Precise speed measurement.
Compact and flat.
Universal mounting bracket, can be easily attached to the wheel hub
Equipped with the BLE 4.2 and ANT+ wireless transfer technologies.
Compatible with most bicycle computers, smartphones and smartwatches without dedicated device locks.

T4CLI000165



SPACY 2

Mounting bracket with an extension arm that can be mounted in front of handlebars for better computer visibility and easy access to control buttons. Intended for Kross computers from the KRC600 series.

MATERIAL	Plastic
ATTACHMENT LOCATION	Handlebars 31.8 mm
COMPATIBILITY	Kross computers from the KRC600 series.

T4CLI000002BK

ACCESSORIES

LIGHTING



RACE 5W CREE SMARTBEAM CUTOFF LINE



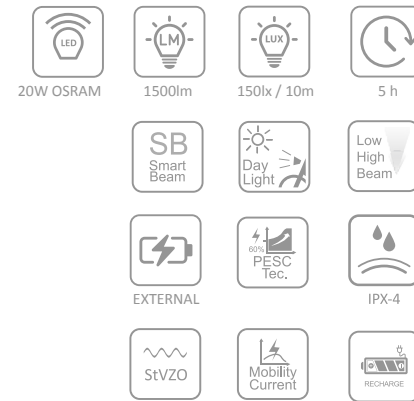

PARSEC 1500

PARSEC 1500 features an exclusive design and the best, high-performance LED bicycle light made for all kinds of serious night riding or for those cyclists who want to be really visible on the road. Compact, durable and heat dissipating aluminum structure. Two efficient 1500 lumen Osram LEDs. Advanced lithium-ion battery that ensures great working time on single charge. The light features a wired control button that lets you change its operating mode quickly and safely.

LIGHTING TYPE	Main light
MATERIAL	Aluminum
ATTACHMENT LOCATION	Handlebars
MOUNTING TYPE	Composite bracket
LIGHT SOURCE	2 x 10 W Osram LEDs P3737
LIGHT OUTPUT	≥ 1500 lm
LUMINANCE	150 lx / 10 m
RANGE	≥ 150 m
LIGHT TEMPERATURE	≥ 6000 K
POWER SOURCE	External battery 3.7 V / 7200 mAh
OPERATING TIME	1-5 h
CHARGING	USB
CHARGING TIME	3 h
TECHNOLOGIES	Smart Beam Day Light Cut off line Mobility Current High/Low Beam Switch AMPR Tec. PESC Tec
FEATURES	Battery level indicator IPX4 water resistance USB-charged Meets the StVZO standard
DIMENSIONS	63 x 63 x 43 mm
WEIGHT	161 g (including bracket)

T4COSLP0255

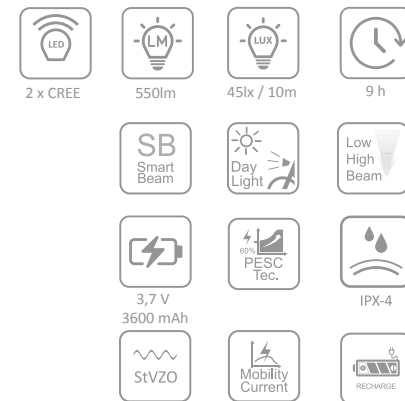

PARSEC 550

PARSEC 550 is a small, lightweight and extremely efficient bicycle light. There are no better words to describe it. Features the latest and brightest XBT LEDs on the market. The lighting power of this powerful unit comes from a hybrid reflector that emits an impressive value of 550+ lumens. The beam pattern of the aluminum reflector is perfect for racing in a dark forest or for fast rides on trails. The light features a wired control button that lets you change its operating mode quickly and safely.

LIGHTING TYPE	Main light
MATERIAL	Aluminum
ATTACHMENT LOCATION	Handlebars
MOUNTING TYPE	Composite bracket
LIGHT SOURCE	10 W CREE XBT LED
LIGHT OUTPUT	≥ 550 lm
LUMINANCE	60 lx / 10 m
RANGE	≥ 125 m
LIGHT TEMPERATURE	≥ 6000 K
POWER SOURCE	External battery 3.7 V / 3600 mAh
OPERATING TIME	9 h
CHARGING	USB
CHARGING TIME	3 h
TECHNOLOGIES	Smart Beam Day Light Cut off line Mobility Current High/Low Beam Switch AMPR Tec. PESC Tec
FEATURES	Battery level indicator IPX4 water resistance USB-charged Meets the StVZO standard
DIMENSIONS	63 x 63 x 43 mm
WEIGHT	161 g (including bracket)

T4COSLP0257

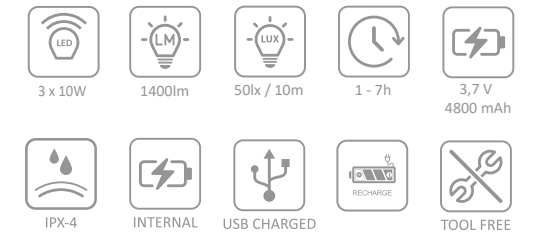

BLADE 1400

BLADE 1400 is an aluminum headlight featuring three LED lights of 10 W each. Light output exceeding 1400 lumens allows you to ride really fast on the most difficult trails, even in the middle of the night. Such an impressive amount of light will let you see every detail and avoid all obstacles. The advanced optics ensures a perfect light distribution. BLADE 1400 features a 4800 mAh battery with a constantly monitored capacity, and the remaining operating time is displayed on a panel located in the upper part of the case. The light may also work as a powerbank, so that you can charge e.g. your phone or the navigating system. It has a very robust structure and the sockets are secured by rubber plugs, so it won't let you down even when the weather does.

LIGHTING TYPE	Main light
MATERIAL	Aluminum / ABS
ATTACHMENT LOCATION	Handlebars
MOUNTING SYSTEM	Rubber O-ring
LIGHT SOURCE	3 x ultra bright 10 W LED lights
LIGHT OUTPUT	1400 lm
LUMINANCE	≥ 50 lx / 10 m
RANGE	≥ 140 m
LIGHT TEMPERATURE	≥ 6000 K
POWER SOURCE	Lithium battery 3.7 V / 4800 mAh
OPERATING TIME	1-7 h
CHARGING	USB
CHARGING TIME	10 h
OPERATING MODE	Constant - 5 Intermittent - 3
FEATURES	Powerbank Battery level indicator Operating time indicator IPX4 water resistance USB-charged
DIMENSIONS	116 x 49 x 34 mm
WEIGHT	232 g (including bracket)

T4COSLP0258

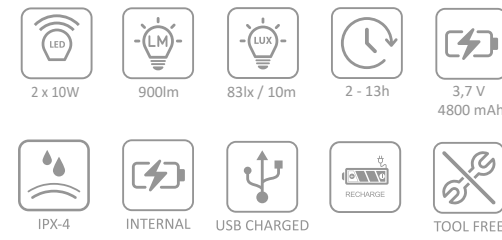

BLADE 1000

BLADE 1000 is an aluminum headlight featuring two LED lights of 10 W each. Light output exceeding 900 lumens allows you to ride really fast on difficult trails, even in the middle of the night. Such an impressive amount of light will let you see every detail and avoid all obstacles. The advanced optics ensures a perfect light distribution. BLADE 1000 features a 4800 mAh battery with a constantly monitored capacity, and the remaining operating time is displayed on a panel located in the upper part of the case. The light may also work as a powerbank, so that you can charge e.g. your phone or the navigating system. It has a very robust structure and the sockets are secured by rubber plugs, so it won't let you down even when the weather does.

LIGHTING TYPE	Main light
MATERIAL	Aluminum / ABS
ATTACHMENT LOCATION	Handlebars
MOUNTING SYSTEM	Rubber O-ring
LIGHT SOURCE	2 x ultra bright 10 W LED lights
LIGHT OUTPUT	900 lm
LUMINANCE	≥ 83 lx / 10 m
RANGE	≥ 180 m
LIGHT TEMPERATURE	≥ 6000 K
POWER SOURCE	Lithium battery 3.7 V / 4800 mAh
OPERATING TIME	2-13 h
CHARGING	USB
CHARGING TIME	10 h
OPERATING MODE	Constant - 5 Intermittent - 3
FEATURES	Powerbank Battery level indicator Operating time indicator IPX4 water resistance USB-charged
DIMENSIONS	116 x 45 x 29 mm
WEIGHT	199 g (including bracket)

T4COSLP0259

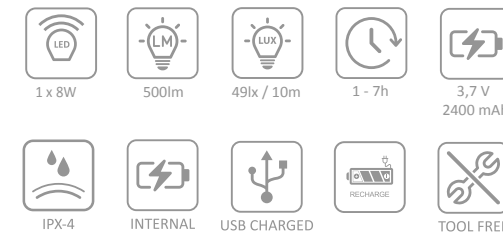

BLADE 500

BLADE 500 is an aluminum headlight featuring an 8 W LED light. Light output exceeding 500 lumens allows you to ride really fast on demanding trails. Such an impressive amount of light will let you see every detail and avoid all obstacles. The advanced optics ensures a perfect light distribution. BLADE 500 features a 2400 mAh battery with a constantly monitored capacity, and the remaining operating time is displayed on a panel located in the upper part of the case. The light may also work as a powerbank, so that you can charge e.g. your phone or the navigating system. It has a very robust structure and the sockets are secured by rubber plugs, so it won't let you down even when the weather does.

LIGHTING TYPE	Main light
MATERIAL	Aluminum / ABS
ATTACHMENT LOCATION	Handlebars
MOUNTING SYSTEM	Rubber O-ring
LIGHT SOURCE	Ultra bright 8 W LED light
LIGHT OUTPUT	500 lm
LUMINANCE	≥ 49 lx / 10 m
RANGE	≥ 140 m
LIGHT TEMPERATURE	≥ 6000 K
POWER SOURCE	Lithium battery 3.7 V / 2400 mAh
OPERATING TIME	1-7 h
CHARGING	USB
CHARGING TIME	10 h
OPERATING MODE	Constant - 5 Intermittent - 3
FEATURES	Powerbank Battery level indicator Operating time indicator IPX4 water resistance USB-charged
DIMENSIONS	111 x 36 x 30 mm
WEIGHT	139 g (including bracket)

T4COSLP0260



RACE

RACE is a technologically advanced light made of aluminum and ABS. Equipped with a quality Cree LED and a battery discharge sensor; charged via USB. The unique mounting system and possibility of integrating the light with selected bicycle computer models allow you to organize your cockpit space. The technologies used make it the ultimate bicycle light. The Smart Beam sensor automatically adjusts lamp power to ambient lighting; the Cut-off Line technology directs the beam where the rider needs it, that is on the road and not towards the sky, making the most of its power without dazzling the oncoming drivers. The built-in accelerometer will automatically turn on the light when movement is detected and turn it off when the bicycle is stationary. The durable and sealed casing protects the light against water penetration, enabling use in difficult weather conditions. Recommended for road bikes and other bikes where the handlebar support is set at a negative angle.

LIGHTING TYPE	Main light
MATERIAL	Aluminum / ABS
ATTACHMENT LOCATION	Handlebar support face
MOUNT TYPE	Aluminum bracket
LIGHT SOURCE	5 W Cree XPE2 R3 LED
LIGHT OUTPUT	300 lm ± 15%
LUMINANCE	≥ 40 lx / 10 m
RANGE	≥ 120 m
LIGHT TEMPERATURE	≥ 6000 K
POWER SOURCE	Lithium battery 1700 mAh
OPERATING TIME	15 h ± 15%
CHARGING	USB
CHARGING TIME	4 h
TECHNOLOGIES	Smart Beam Day Light Cut off line Auto ON/OFF Mobility Current Low Beam AMPR Tec. Speed Tec.
FEATURES	Aluminum mount for handlebar support Integrated bicycle computer bracket Battery level indicator IPX4 water resistance USB-charged Meets the StVZO standard
DIMENSIONS	90 x 44 x 46 mm
WEIGHT	146 g (including bracket)

T4COSLP0210



TURISMO PRO

A technologically advanced light made of high-quality materials. Equipped with a quality Cree™ XPE2 R3 LED and a battery discharge sensor; charged via USB. Thanks to a unique technology and the Smart Beam sensor, the light automatically adjusts its power to ambient light. The Power Energy Saver Control technology breaks the conservation of mass law, extending the operating time to 3-12 h. The Cut-off Line technology directs the beam where the rider needs it, that is on the road and not towards the sky, making the most of its power without dazzling the oncoming drivers. The built-in accelerometer will automatically turn on the light when movement is detected and turn it off when the bicycle is stationary. During the day, the daylight mode turns on automatically and when riding through a tunnel, an underpass, at dawn or in rain, that is when visibility is limited, the light will automatically switch from daylight mode to the main lighting mode. At night, the light turns on in the main lighting mode, and beam intensity will be automatically adjusted to ambient light. The intuitive mounting system allows you to quickly move the light to another bike. The sealed casing protects the light against water penetration, enabling use in difficult weather conditions.

LIGHTING TYPE	Main light
MATERIAL	ABS / PC
ATTACHMENT LOCATION	Handlebars
MOUNTING SYSTEM	Composite clasp
LIGHT SOURCE	3.5 W CREE XPE2 R3 LED
LIGHT OUTPUT	≥ 180 lm
LUMINANCE	32 lx / 10 m
RANGE	≥ 100 m
LIGHT TEMPERATURE	6000 K
POWER SOURCE	Lithium battery 3.7 V 1200 mAh
OPERATING TIME	3-12 h
CHARGING	USB
CHARGING TIME	4 h
TECHNOLOGIES	Smart Beam Low Beam PESC Tec Mobility Current Auto on/off Day Light Speed Tec
FEATURES	Built-in battery level indicator IPX4 water resistance USB-charged Meets the StVZO standard
DIMENSIONS	81 x 46 x 37 mm
WEIGHT	88 g (including bracket)

T4COSLP0217



TURISMO RACE

A technologically advanced light made of high-quality materials. Equipped with a quality Cree™ XPE2 R3 LED and a battery charge sensor; charged via USB. Thanks to the unique Low Beam technology that features intelligent light distribution, the immediate space in front of the bicycle is well illuminated. The Power Energy Saver Control technology breaks the conservation of mass law, extending the operating time to 3.5 h. The Cut-off Line technology directs the beam where the rider needs it, that is on the road and not towards the sky, making the most of its power without dazzling the oncoming drivers. The intuitive mounting system allows you to quickly move the light to another bike. The sealed casing protects the light against water penetration, enabling use in difficult weather conditions.

LIGHTING TYPE	Main light
MATERIAL	ABS / PC
ATTACHMENT LOCATION	Handlebars
MOUNTING SYSTEM	Composite clasp
LIGHT SOURCE	2.5W CREE XPE2 R3 LED
LIGHT OUTPUT	180 lm ± 15%
LUMINANCE	30 lx / 10 m
RANGE	≥ 95 m
LIGHT TEMPERATURE	6000 K
POWER SOURCE	Lithium battery 3.7 V 1200 mAh
OPERATING TIME	3 h ± 15% in Turbo mode 6 h ± 15% in Normal mode
CHARGING	USB
CHARGING TIME	2-3 h
TECHNOLOGIES	Low Beam PESC Tec Mobility Current Cut-off Line
FEATURES	Built-in battery level indicator IPX4 water resistance USB-charged Meets the StVZO standard
DIMENSIONS	81 x 46 x 37 mm
WEIGHT	81 g (including bracket)

T4COSLP0218



TURISMO SPORT

A technologically advanced light made of high-quality materials. Equipped with a quality Cree™ XPE2 R3 LED and a battery charge sensor. Thanks to the unique Low Beam technology that features intelligent light distribution, the immediate space in front of the bicycle is well illuminated. The Power Energy Saver Control technology breaks the conservation of mass law, extending the operating time up to 12 h in the Eco mode. The Cut-off Line technology directs the beam where the rider needs it, that is on the road and not towards the sky, making the most of its power without dazzling the oncoming drivers. The intuitive mounting system allows you to quickly move the light to another bike. The sealed casing protects the light against water penetration, enabling use in difficult weather conditions.

LIGHTING TYPE	Main light
MATERIAL	ABS / PC
ATTACHMENT LOCATION	Handlebars
MOUNTING SYSTEM	Composite clasp
LIGHT SOURCE	3.5 W CREE XPE2 R3 LED
LIGHT OUTPUT	150 lm ± 15%
LUMINANCE	30 lx / 10 m
RANGE	≥ 95 m
LIGHT TEMPERATURE	6000 K
POWER SOURCE	3 AAA batteries
OPERATING TIME	8 h ± 15% in Normal mode 12 h ± 15% in Eco mode
TECHNOLOGIES	Low Beam PESC Tec Mobility Current Cut-off Line
FEATURES	Built-in battery level indicator IPX4 water resistance USB-charged Meets the StVZO standard
DIMENSIONS	86 x 46 x 37 mm
WEIGHT	72 g (including bracket)

T4COSLP0219

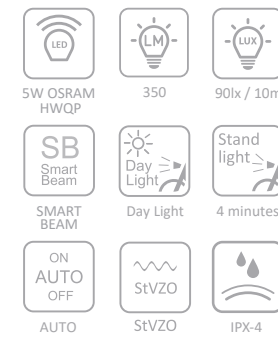

DYNLIGHT 90

Dynlight 90 is a dynamo headlight made of aluminium and ABS plastic. It has very strong power output of 90 lux. Thanks to applied technologies and modern construction, the lamp has a powerful range up to 150 m. Both power and range combined with the integrated reflectors would increase safety, visibility of user and visibility of others. Thanks to the Auto On function, the light automatically turns on Day Light mode, increasing the user's safety. In the evening, when the sunlight becomes weaker, the twilight sensor switches the light into Main mode, while the Smart Beam sensor adjusts the intensity of emitted light. Standlight and Power Management technologies allow the light to work up to 4 minutes after stop of the bike. The solid axis endurance all kind of path and allows to suit the light to the optimal position.

LIGHTING TYPE	Main light
MATERIAL	Aluminum, ABS
ATTACHMENT LOCATION	Fork crown
MOUNTING SYSTEM	Alloy bracket
LIGHT SOURCE	5 W Osram HWQP LED
LIGHT OUTPUT	350 lm
LUMINANCE	≥ 90 lx / 10 m
RANGE	150 m
LIGHT TEMPERATURE	≥ 6000 K
POWER SOURCE	Dynamo hub
MODES	ON/OFF/S (Smart Beam)
TECHNOLOGIES	Auto On/Off Smart Beam Low Beam Day Light Standlight Power Management
FEATURES	IPX4 water resistance Meets the StVZO standard
DIMENSIONS	68 x 43 x 64 mm
WEIGHT	145 g (including bracket)

T4COSLP0211



DYNLIGHT 30

Dynlight 30 is a bicycle headlight made of ABS. Powered by dynamo hub. The compact headlight boasts a high luminance of 30 lx and a features sporty feel. Thanks to the technologies used and the modern construction, the light has a long range of 95 m. Its power and range combined with the integrated reflection increase safety, allowing you to see and be seen. Upon manual turn-on in daylight, the light will work in the Day Light mode, increasing your safety, while in the evening, Main Beam is the default mode. Standlight and Power Management technologies allow to keep the light on for up to 4 minutes when stationary. A durable plastic bracket attached to the fork crown allows you to adjust the light to an optimal position.

LIGHTING TYPE	Main light
MATERIAL	ABS
ATTACHMENT LOCATION	Fork crown
MOUNTING SYSTEM	Composite clasp
LIGHT SOURCE	2 W CREE XPE2 R3 LED
LIGHT OUTPUT	135 lm
LUMINANCE	≥ 30 lx / 10 m
RANGE	95 m
LIGHT TEMPERATURE	6000 K
POWER SOURCE	Dynamo hub
CONTROL	ON/OFF
TECHNOLOGIES	Standlight Power Management
FEATURES	IPX4 water resistance Meets the StVZO standard
DIMENSIONS	69 x 37 x 53 mm
WEIGHT	100 g (including bracket)

T4COSLP0213

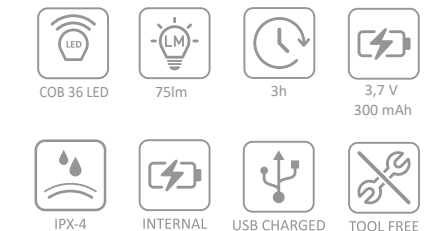

SAFETY F

SAFETY F is a very bright and compact bicycle light. 75 lumens ensure visibility in any weather conditions. The modern design makes it a great addition to any bicycle. A special built-in battery level indicator will let you know when it's time to charge the built-in battery, and the long operating time will keep you safe during every ride. The sealed casing protects the light against water penetration, enabling use in difficult weather conditions.

LIGHTING TYPE	Emergency (complementary)
MATERIAL	Aluminum / ABS
ATTACHMENT LOCATION	Handlebars
MOUNTING SYSTEM	Silicone clasp
LIGHT SOURCE	COB platform with 36 LEDs
LIGHT OUTPUT	75 lm
OPERATING MODE	Constant - 2 h Intermittent - 3 h
POWER SOURCE	Lithium battery 3.7 V / 300 mAh
OPERATING TIME	≥ 3 h
CHARGING	USB
CHARGING TIME	±3 h
FEATURES	Battery level indicator IPX4 water resistance USB-charged All-purpose mounting bracket
DIMENSIONS	41 x 38 x 23 mm
WEIGHT	48 g

T4COSLP0261



QUARK F2.0

A modern, dual-function bicycle headlight made of plastic. Equipped with a quality 1.5 W OSRAM LED and a battery charge sensor. The intuitive mounting system allows you to quickly move the light to another bike. The sealed casing protects the light against water penetration, enabling use in difficult weather conditions.

LIGHTING TYPE	Main light
MATERIAL	ABS / PC
ATTACHMENT LOCATION	Handlebars
MOUNTING SYSTEM	Silicone clasp
LIGHT SOURCE	Osram LED 1.5 W
LIGHT OUTPUT	80 lm ± 20%
LUMINANCE	10 lx / 10 m
RANGE	≥ 70 m
LIGHT TEMPERATURE	≥ 6500 K
POWER SOURCE	Lithium battery 280 mAh
OPERATING TIME	2-7 h
CHARGING	USB
CHARGING TIME	±2 h
OPERATING MODE	Constant Intermittent
TECHNOLOGIES	Low Beam Mobile Current
FEATURES	Built-in battery level indicator IPX4 water resistance Tool-free mounting USB-charged
DIMENSIONS	75 x 30 x 42 mm
WEIGHT	40 g

T4COSLP0220



QUARK F1.0

A modern, dual-function bicycle headlight made of plastic. Equipped with a quality 1 W OSRAM LED. The intuitive mounting system allows you to quickly move the light to another bike. The sealed casing protects the light against water penetration, enabling use in difficult weather conditions.

LIGHTING TYPE	Main light
MATERIAL	ABS / PC
ATTACHMENT LOCATION	Handlebars
MOUNTING SYSTEM	Silicone clasp
LIGHT SOURCE	Osram LED 1 W
LIGHT OUTPUT	60 lm ± 15%
LUMINANCE	8 lx / 10 m
RANGE	≥ 50 m
LIGHT TEMPERATURE	≥ 6500 K
POWER SOURCE	AA battery
OPERATING TIME	2-5 h
OPERATING MODE	Constant Intermittent
TECHNOLOGIES	Low Beam Mobile Current
FEATURES	IPX4 water resistance Tool-free mounting
DIMENSIONS	83 x 34 x 40 mm
WEIGHT	42 g (without battery)

T4COSLP0221



LUMI II

A bicycle headlight made of lightweight plastic. The sealed casing protects the light against water penetration, enabling use in difficult weather conditions. Features 3 long-life LED lights. Variable operating modes allow you to save energy and adjust the light intensity to the current visibility conditions. The intuitive and straightforward mounting system allows you to quickly move the light to another bike.

LIGHTING TYPE	Main light
MATERIAL	ABS / PC
ATTACHMENT LOCATION	Handlebars
MOUNTING SYSTEM	Composite clasp
LIGHT SOURCE	3 x 0.5 W LED lights
LIGHT OUTPUT	22 lm
LUMINANCE	2.3 lx / 10 m
RANGE	≥ 30 m
LIGHT TEMPERATURE	6000 K
POWER SOURCE	3 AAA batteries.
OPERATING MODE	Constant Intermittent
FEATURES	IPX4 water resistance Tool-free mounting and removal
DIMENSIONS	82 x 49 x 74 mm
WEIGHT	36 g

T4COSLP0222BK

black

T4COSLP0222GY

grey



NEAT

A modern, dual-function bicycle headlight made of aluminum and plastic. Features 3 ultra bright LED lights and a battery charge sensor; charged via USB. The intuitive mounting system allows you to quickly move the light to another bike. The sealed casing protects the light against water penetration, enabling use in difficult weather conditions.

LIGHTING TYPE	Emergency (complementary)
MATERIAL	Aluminum / PC
ATTACHMENT LOCATION	Handlebars
MOUNTING SYSTEM	Rubber clasp
LIGHT SOURCE	3 ultra bright LED lights
LIGHT OUTPUT	16 lm
LUMINANCE	100 lx / 2 m
LIGHT TEMPERATURE	6000 K
POWER SOURCE	Lithium battery 3.7 V 300 mAh
CHARGING TIME	2 h
OPERATING MODE	Constant Intermittent
FEATURES	Built-in battery level indicator Tool-free mounting and removal IPX4 water resistance USB-charged
DIMENSIONS	51 x 32 x 21 mm
WEIGHT	27 g (including bracket)

T4COSLP0223



NATTY

A modern, dual-function bicycle headlight made of plastic. Equipped with a quality 1 W OSRAM LED and a battery charge sensor. The intuitive mounting system allows you to quickly move the light to another bike. The sealed casing protects the light against water penetration, enabling use in difficult weather conditions.

LIGHTING TYPE	Main light
MATERIAL	PC
ATTACHMENT LOCATION	Handlebars
MOUNTING SYSTEM	Composite clasp
LIGHT SOURCE	Osram LED 1 W
LIGHT OUTPUT	57 lm
LUMINANCE	25 lx / 10 m
LIGHT TEMPERATURE	5400 K
POWER SOURCE	4 AAA batteries
OPERATING MODE	Constant Intermittent
FEATURES	Tool-free mounting Built-in battery level indicator IPX4 water resistance
DIMENSIONS	94 x 42 x 37 mm
WEIGHT	75 g (including bracket)

T4COSLP0224

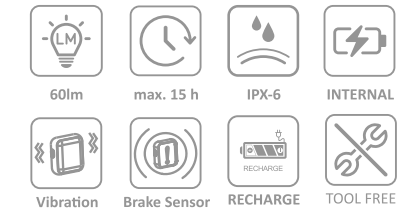

NEW

STOP&GO

STOP&GO is a new, small, sleek and portable rear bicycle light incorporating the latest technical solutions. Thanks to the high power of COB LEDs, its maximum output power is up to 60 lumens, while the advanced optics design provides up to 180 degrees of visibility. The lamp is equipped with a state-of-the-art vibration sensor that detects when the cyclist is braking and then flashes up to 60 lumens to warn fellow travellers. The light pattern emitted during braking will be bright enough to draw attention, but not so bright as to cause temporary glare, which is an equally likely cause of accidents. Thanks to the same sensors, after a minute of inactivity the rear light goes into sleep mode to save energy. Any movement immediately wakes the lamp from the sleep mode. Three brightness levels, a continuous mode and two flash modes can all be used in any combo. Note that the high mode gives 30 lumens, while the medium and low modes give 17 and 9 lumens respectively. Installation and removal of the rear light is very easy, simply rotate it 90 degrees. The micro-USB charging port is built into the back of the light, thanks to which it is IPX6 waterproof.

MATERIAL	Aluminium / ABS
MOUNTING LOCATION	Seatpost
INSTALLATION METHOD	Silicone O-ring
LIGHT SOURCE	COB LED panel
LUMINOUS FLUX	60 lm
VISIBILITY	1500 m
OPERATING MODE	Continuous – 1 / flashing – 2 (3 power modes)
POWER SUPPLY	3.7 V / 500 mAh lithium battery
WORKING TIME	≥2h–15h
CHARGING TIME	±2h
CHARGING	USB
FEATURES	Auto Brake System Auto sleep/wake-up system Battery level indicator IPX6 waterproof
DIMENSIONS	41 x 33 x 23 mm
WEIGHT	34 g

T4COSLT0150

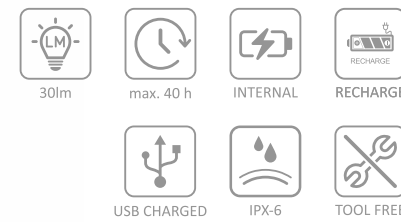

NEW

RED LINE II

The Red Line II rear lamp features a compact shape, low weight, and very good visibility, increasing the cyclist's safety. The new lamp design offers a more even, uniform beam of light, spreading at an angle of 230 degrees behind the cyclist, with excellent side visibility. At the highest setting, the bicycle rear light is visible even from a distance of 800 m. RED LINE II offers 1 permanent mode with 30, 15 and 7 lumens at the high, medium, and low setting respectively, and 3 flash settings depending on the user's preferences. The lamp has several other advanced features to maximise user comfort and ease of use. The built-in infrared sensor detects ambient light and automatically adjusts the output power to suit day or night mode. The battery level indicator informs the cyclist with a light signal when the battery capacity drops to 5%. This indicates that there is energy left for 20 minutes of operation. The high IPX6 waterproof rating makes the Red Line II weatherproof.

MATERIAL	ABS / PC
ATTACHMENT LOCATION	Seatpost
MOUNTING SYSTEM	Silicone clamp
LIGHT SOURCE	COB LED panel
LUMINOUS FLUX	30 lm
LIGHT INTENSITY	6 lx / 10 m
VISIBILITY	800 m
OPERATING MODE	Continuous - 1 (3 power modes) / flashing - 3
POWER SUPPLY	3.7 V / 330 mAh lithium battery
WORKING TIME	≥2h-40h
CHARGING	USB
CHARGING TIME	±1.5h
TECHNOLOGIES	Smart Beam Intermittent
FEATURES	Automatic mode and light output adjustment depending on ambient conditions Memory of the last mode Battery level indicator IPX6 waterproof USB charging Tool-free installation and removal
DIMENSIONS	61 x 15 x 21 mm
WEIGHT	25 g

T4COSLT0151

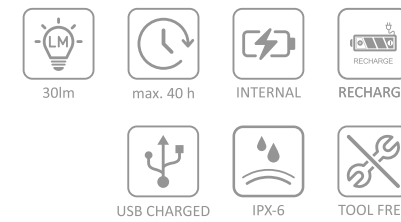

NEW

RED SHIFT

A rear lamp equipped with a 20 lumen COB LED. Housing made from polycarbonate and ABS. Fastening by means of a composite clamp. Excellent side visibility thanks to the unique lens profile. An internal 360 mAh lithium battery charged via a micro-USB cable (included). Battery life and charge indicator. Battery life: 500 full charge cycles. One continuous light mode (20 lm - 4 h) and 2 flashing light modes. Compliance with the strict requirements of the German Road Traffic Law (StVZO).

MATERIAL	ABS / PC
MOUNTING LOCATION	Seatpost
INSTALLATION METHOD	Silicone clamp
LIGHT SOURCE	8 LED COB panel
LUMINOUS FLUX	20 lm
VISIBILITY	≥ 200 m
OPERATING MODE	Continuous - 1
POWER SUPPLY	3.7 V / 360 mAh lithium battery
WORKING TIME	≥ 4h
CHARGING	USB
CHARGING TIME	± 2h
TECHNOLOGIES	StVZO Mobility Current PESC Tech
FEATURES	Battery level indicator IPX4 waterproof Charging via USB Tool-free installation and removal
DIMENSIONS	61 x 30 x 21 mm
WEIGHT	49 g

T4COSLT0152

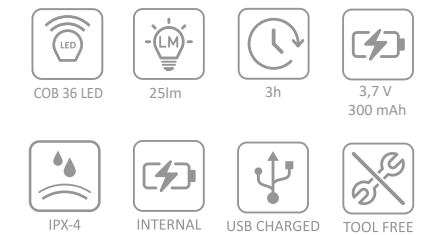

SAFETY R

SAFETY R is a very bright and compact bicycle light. 25 lumens ensure visibility in any weather conditions. The modern design makes it a great addition to any bicycle. A special battery level indicator will let you know when it's time to charge the battery and the long operating time will keep you safe during every ride. The sealed casing protects the light against water penetration, enabling use in difficult weather conditions.

MATERIAL	Aluminum / ABS
ATTACHMENT LOCATION	Handlebars
MOUNTING SYSTEM	Silicone clamp
LIGHT SOURCE	COB platform with 36 LEDs
LIGHT OUTPUT	25 lm
OPERATING MODE	Constant - 2 Intermittent - 3
POWER SOURCE	Lithium battery 3.7 V / 300 mAh
OPERATING TIME	≥ 3 h
CHARGING	USB
CHARGING TIME	±3 h
FEATURES	Battery level indicator IPX4 water resistance USB-charged All-purpose mounting bracket
DIMENSIONS	41 x 38 x 23 mm
WEIGHT	48 g

T4COSLT0149



RED FERRIS

The RED FERRIS backlight will keep you safe and visible outdoors for up to 30 hours. This stylish and compact light weighs just 18 g. It is easily attached to your helmet or seatpost and features many available operating modes that improve your visibility.

MATERIAL	ABS / PC
ATTACHMENT LOCATION	Seatpost / helmet
MOUNTING SYSTEM	Rubber clasp
LIGHT SOURCE	12 LDE COB module
LIGHT OUTPUT	18 lm
OPERATING MODE	Constant - 1 Intermittent - 5
POWER SOURCE	Built-in 3.7 V / 200 mAh battery
OPERATING TIME	≥ 30 h
CHARGING	USB
CHARGING TIME	±3 h
FEATURES	IPX4 water resistance Battery level indicator Tool-free mounting and removal
DIMENSIONS	40 x 40 x 22 mm
WEIGHT	18 g, including bracket

T4COSLT0148

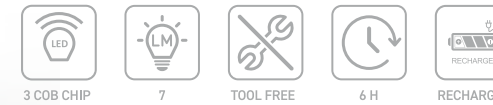

QUARK R2.0

A bicycle backlight in a plastic case. Features a COB platform with 3 LED lights. The intuitive mounting system allows you to quickly move the light to another bike. The sealed casing protects the light against water penetration, enabling use in difficult weather conditions.

MATERIAL	ABS / PC
ATTACHMENT LOCATION	Seatpost
MOUNTING SYSTEM	Silicone clasp
LIGHT SOURCE	3 COB 0.3 W LED lights
LIGHT OUTPUT	7 lm ± 20%
LUMINANCE	2 cd ± 20%
OPERATING MODE	Constant Intermittent
POWER SOURCE	Built-in 3.7 V / 200 mAh battery
OPERATING TIME	≥ 4 h
FEATURES	Battery level indicator IPX4 water resistance All-purpose mounting bracket
DIMENSIONS	65 x 25 x 22 mm
WEIGHT	18.5 g (including bracket)

T4COSLT0143



QUARK R1.0

A bicycle backlight in a plastic case. Features a COB platform with 3 LED lights. The intuitive mounting system allows you to quickly move the light to another bike. The sealed casing protects the light against water penetration, enabling use in difficult weather conditions.

MATERIAL	ABS / PC
ATTACHMENT LOCATION	Seatpost
MOUNTING SYSTEM	Silicone clasp
LIGHT SOURCE	3 COB 0.2 W LED lights
LIGHT OUTPUT	4 lm ± 20%
LUMINANCE	6 cd ± 20%
OPERATING MODE	Constant Intermittent -1
POWER SOURCE	AAA battery
OPERATING TIME	≥ 5 h
FEATURES	Battery level indicator IPX4 water resistance Meets the StVZO standard All-purpose mounting bracket
DIMENSIONS	65 x 25 x 22 mm
WEIGHT	15 g (without battery)

T4COSLT0147



RED DRAL II

A backlight made of lightweight, yet durable plastic, designed for seatpost attachment. The sealed casing protects the light against water penetration, enabling use in difficult weather conditions. Features 3 LED lights, a battery discharged sensor and a built-in battery charged via USB. The easy and universal mounting system allows you to use the light with different bikes.

MATERIAL	PC / TPR
ATTACHMENT LOCATION	Seatpost
MOUNTING SYSTEM	Silicone clasp
LIGHT SOURCE	3 LED lights
LIGHT OUTPUT	3 lm
OPERATING MODE	Constant Intermittent
LUMINANCE	2 cd ± 20%
POWER SOURCE	Built-in 3.7 V / 150 mAh battery
OPERATING TIME	≥ 4-20 h
CHARGING	USB
CHARGING TIME	±3 h
FEATURES	Meets the StVZO standard IPX4 water resistance Battery discharge sensor Tool-free mounting and removal
DIMENSIONS	68.5 x 43.4 x 38 mm
WEIGHT	22 g

T4COSLT0142



RED DRAL

Lamp made of lightweight plastic composite, mounted on the seat post. Sealed enclosure protects against water damage, thus allowing to be used in harsh weather conditions, with 3 LEDs and the sensor battery. Used easy assembly system, allows you to use the lights in a variety of bikes.

MATERIAL	PC / TPR
ATTACHMENT LOCATION	Seatpost
MOUNTING SYSTEM	Silicone clamp
LIGHT SOURCE	3 LEDs
LIGHT OUTPUT	3 lm
OPERATING MODE	Constant Blinking
LUMINANCE	2 cd ± 20%
POWER SOURCE	2 CR2032 batteries (included)
FEATURES	Meets the StVZO standard IPX4 water resistance Battery indicator Tool-free mounting and removal
DIMENSIONS	68.5 x 43.4 x 38 mm
WEIGHT	22 g

T4COSLT0145



LITTLE RED

A minimalist bicycle backlight in a plastic case. Features an ultra bright LED and a battery charge sensor; charged via USB. The intuitive mounting system allows you to quickly move the light to another bike. The sealed casing protects the light against water penetration, enabling use in difficult weather conditions.

MATERIAL	PC
ATTACHMENT LOCATION	Seatpost
MOUNTING SYSTEM	Rubber O-ring
LIGHT SOURCE	1 ultra bright LED light
LIGHT OUTPUT	5.5 lm
OPERATING MODE	Constant
LUMINANCE	1 lx / 2 m
POWER SOURCE	Built-in 3.7 V / 240 mAh battery
OPERATING TIME	≥ 4 h
CHARGING	USB
CHARGING TIME	2-3 h
FEATURES	Tool-free mounting Built-in battery level indicator IPX4 water resistance All-purpose mounting bracket
DIMENSIONS	34 x 25 x 18 mm
WEIGHT	27 g

T4COSLT0146



RED BLIK

A bicycle backlight in a plastic case. Features a COB platform with 15 LED lights. The intuitive mounting system allows you to quickly move the light to another bike. The sealed casing protects the light against water penetration, enabling use in difficult weather conditions.

MATERIAL	PC
ATTACHMENT LOCATION	Seatpost
MOUNTING SYSTEM	Rubber clasp
LIGHT SOURCE	15 LDE COB module
LIGHT OUTPUT	5 lm
LUMINANCE	0.5 lx / 2 m
OPERATING MODE	Constant Intermittent
POWER SOURCE	2 CR2032 batteries
OPERATING TIME	≥ 4 h
FEATURES	Tool-free mounting IPX4 water resistance
DIMENSIONS	55 x 28 x 17 mm
WEIGHT	35 g (including bracket)

T4COSLT0136



VULCANO

Two super bright LED distribute light evenly. Kross light exudes simplicity and functionality, which adds a unique artistic and personality to the Kross light collection. The main features of this rear light are the very compact size. You're also visible from the side. The cyclist is not only seen from behind, but also from the side to crossing traffic. Unique optical design provides ultra brightness and efficiency. With integrated reflector, provides the utmost safety. When stationary, the lamp continues to light up for a 4 minutes.

MATERIAL	ABS / Acrylic
ATTACHMENT LOCATION	Rear carrier's metal plate
MOUNTING SYSTEM	Hex nut
LIGHT SOURCE	2 red LEDs
POWER SOURCE	Dynamo hub AC 6 V 0.6 W
OPERATING MODE	Constant
FEATURES	4-minute standlight K Mark (StVZO) Certified Integrated reflector Water and shock resistant IPX4 water resistance Fixing distance 50 mm
WEIGHT	44 g

T4COSLT0139

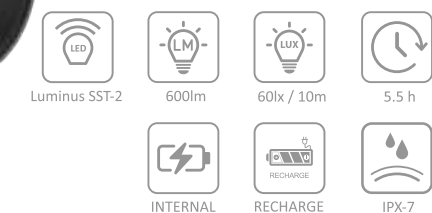

NEW

VISION SET

Vision Set is a high-quality set of modern bicycle lights. The front lamp provides a luminous flux of up to 600 lumens, and thanks to its long range of 106 metres, it perfectly illuminates the road in front of the cyclist. The advanced anti-glare lens system directs the beam of light onto the road, so that the oncoming traffic is not dazzled. The body of the front lamp, made of heat-dissipating A6061-T6 aluminium, is additionally very well sealed to achieve IPX7 water resistance rating. Thanks to its design, the ultra-safe rear light ensures 230° visibility. The emitted luminous flux is powerful enough to attract attention without dazzling those behind. With a low-power mode and an easy-to-read power indicator, you do not have to worry about sudden power cuts. Thanks to compatibility with the GARMIN mounting system, the front light of the Vision Set can be stably mounted in the mounting brackets on helmets, as well as on the handlebar or the stem.

LIGHT TYPE	Illuminating (full beam)
MATERIAL	Aluminium / ABS / PC
MOUNTING LOCATION	Handlebar, seatpost
INSTALLATION METHOD	GARMIN mount, silicone clamp
LIGHT SOURCE	Front: Luminus SST-20 / rear: COB LED
LUMINOUS FLUX	Front: 600 lm / rear: 30 lm
LIGHT INTENSITY	60 lx / 10 m rear: 6 lx / 10 m
RANGE	≥ 106 m
VISIBILITY	≥ 800 m
POWER SUPPLY	Front: 3.7 V 1600 mAh / rear: 3.7 V 330 mAh
WORKING TIME	Front 1.5–5.5h, rear 2–40h
CHARGING TIME	Front ±2.5h, back ±1.5h
CHARGING	Front USB-C, back micro-USB
TECHNOLOGIES	Smart Beam Auto Safe Mode
FEATURES	Built-in battery level indicator Helmet-mountable Garmin-compatible mount IPX7 / IPX5 waterproof Tool-free installation and removal
DIMENSIONS	Front: 87 x 31 x 31 mm Rear: 61 x 15 x 21 mm
WEIGHT	132 g with mounts

T4COS000084

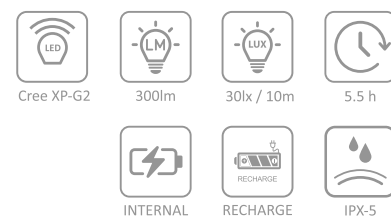

NEW

QUBIC SET

Qubic Set is a set of minimalist, unconventional bicycle lights. Despite its small size, the front lamp, equipped with a Cree XP-G2 LED, emits a luminous flux of up to 300 lumens. With a range of over 80 metres, it provides high visibility to both the cyclist and nearby traffic. The easy-to-read battery level indicator is built into the power button. The high-performance rear light produces an output of 20 lumens thanks to the COB LED. The wide 180-degree visibility radius ensures safety during cycling trips. The centrally located power button is very easy to access, so you no longer need to stop to switch on the light while cycling. Both lights have a built-in battery that is charged via a mini-USB. The front light can be mounted on handlebars with a diameter of 22-35 mm.

LIGHTING TYPE	Lighting (road)
MATERIAL	ABS / PC
MOUNTING LOCATION	Handlebar, seatpost
INSTALLATION METHOD	Silicone clamp
LIGHT SOURCE	Front: Cree XP-G2 LED / rear: COB LED
LUMINOUS FLUX	Front: 300 lm / rear: 20 lm
LIGHT INTENSITY	Front: ≥ 30 lx / 10 m / rear: 3lx / 10 m
RANGE	≥ 80 m
VISIBILITY	≥ 800 m
POWER SUPPLY	Front: 3.7 V 1600 mAh / rear: 3.7 V 240 mAh
WORKING TIME	Front 2 – 5.5h, rear 1.5 – 21h
CHARGING	Micro USB
CHARGING TIME	Front ±1.5h, back ±1.5h
OPERATING MODE	Continuous – 2 flashing – 1
FEATURES	Battery level indicator IPX5 waterproof USB charging Tool-free installation and removal
DIMENSIONS	Front: 59 x 38 x 31 mm Rear: 31 x 30 x 23 mm
WEIGHT	81 g

T4COS000085

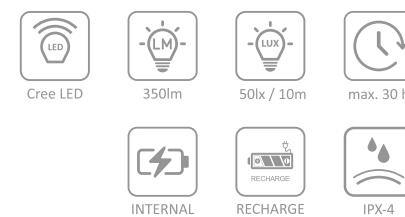

NEW

MOVE SET

Move Set is a set of unique bicycle lights that provide excellent visibility on the road. The unique lens design of the front lamp reflector makes the emitted light as bright as those produced by car headlights. Now, when cycling, even the uneven roadside can be seen clearly, as if it were illuminated by car headlights. The front, technically advanced lamp features technologies such as: Cut-off line, which protects the eyes of oncoming road users from being dazzled, Low Beam, which ensures that the light falling on the roadside is effectively diffused, and Mobile Current, which significantly increases the operating time. The rear lights significantly increase the safety of the cyclist and allow other vehicles to see the bike in difficult weather conditions such as rain or snow. A bright, reliable rear light is essential for road safety! And this is exactly what the rear light from the Move Set provides. Its compact shape coincides with the line of the seatpost, blending with it. A wide 220° viewing angle ensures very good visibility, even for vehicles approaching from the side. Quick and easy installation thanks to rubber O-rings. Compatible with seatpost diameters of Ø 25-32 mm.

LIGHTING TYPE	Illuminating (full beam)
MATERIAL	ABS / PC
MOUNTING LOCATION	Handlebar / seatpost
INSTALLATION METHOD	Silicone clamp
LIGHT SOURCE	Front: CREE LED / rear: 3 COB LED module
LUMINOUS FLUX	Front: 360 lm ± 20% / rear: 7 lm ± 20%
LIGHT INTENSITY	Front: 50 lx / 10 m / rear: 2 cd ± 20%
RANGE	≥ 145 m
POWER SUPPLY	1200 mAh lithium battery front / rear: 280 mAh
WORKING TIME	Front: up to 30h / rear: 9.5h
CHARGING	Micro USB
CHARGING TIME	± 3h
TECHNOLOGIES	Mobility Current Beam Switch AMPR Technology PESC Technology
OPERATING MODE	Continuous - 1 flashing - 1
FEATURES	Battery level indicator IPX4 waterproof USB charging Tool-free installation and removal
DIMENSIONS	Front: 94 x 44 x 59.5 mm Rear: 65 x 25 x 22 mm
WEIGHT	114.5 g (with handle)

T4COS000086



TURISMO SET

TURISMO LIGHT SET is a set of compact bicycle lights with contemporary and ergonomic shapes. The unique optics guarantees high brightness and efficiency. The 150 lumen headlight will perfectly illuminate your road up to 90 meters ahead. Thanks to its special construction, the backlight ensures visibility within the range of 220°. The intuitive mounting system allows you to quickly move the light to another bike.

LIGHTING TYPE	Main light
MATERIAL	ABS / PC
ATTACHMENT LOCATION	Handlebars / seatpost
MOUNTING SYSTEM	Composite bracket, silicone clasp
LIGHT SOURCE	Headlight: 3.5 W CREE XPE2 R3 LED / backlight: 3 LED lights
LIGHT OUTPUT	150 lm ± 15%
LUMINANCE	25 lx / 10 m
RANGE	≥ 90 m
LIGHT TEMPERATURE	≥ 6000 K
POWER SOURCE	Headlight: 3 AAA batteries / backlight: 2 x CR2032
OPERATING TIME	8 h ± 15% in Normal mode / 12 h ± 15% in Eco mode
TECHNOLOGIES	Low Beam PESC Tec Mobility Current Cut-off Line
FEATURES	Built-in battery level indicator IPX4 water resistance Meets the StVZO standard Tool-free mounting and removal
DIMENSIONS	Headlight: 86 x 46 x 37 mm Backlight: 68 x 43 x 38 mm
WEIGHT	94 g (including bracket)

T4COS000075



QUARK SET 2.0

A lightweight set of two bicycle lights in plastic cases. The light is provided by a quality OSRAM LED and 3 LED lights on a COB platform. The intuitive mounting system allows you to quickly move the light to another bike. The sealed casing protects the light against water penetration, enabling use in difficult weather conditions.

LIGHTING TYPE	Main light
MATERIAL	ABS / PC
ATTACHMENT LOCATION	Handlebars / seatpost
MOUNTING SYSTEM	Silicone clasp
LIGHT SOURCE	Headlight: 1.5 W Osram LED / backlight: 3 COB LED lights module
LIGHT OUTPUT	Headlight: 80 lm ± 20% / backlight: 7 lm ± 20%
LUMINANCE	Headlight: 10 lx / 10 m / backlight: 2 cd ± 20%
RANGE	≥ 70 m
POWER SOURCE	Lithium battery headlight / backlight: 280 mAh
OPERATING TIME	Headlight: 7 h / backlight: 9.5 h:
CHARGING TIME	±2 h
OPERATING MODES	Constant Intermittent
FEATURES	Tool-free mounting IPX4 water resistance All-purpose mounting bracket
DIMENSIONS	Headlight: 75 x 30 x 42 mm Backlight: 65 x 25 x 22 mm
WEIGHT	58.5 g (including bracket)

T4COS000078



QUARK SET 1.0

A lightweight set of two bicycle lights in plastic cases. The light is provided by a quality OSRAM LED and 3 LED lights on a COB platform. The intuitive mounting system allows you to quickly move the light to another bike. The sealed casing protects the light against water penetration, enabling use in difficult weather conditions.

LIGHTING TYPE	Main light
MATERIAL	ABS / PC
ATTACHMENT LOCATION	Handlebars / seatpost
MOUNTING SYSTEM	Silicone clasp
LIGHT SOURCE	Headlight: 1 W Osram LED / backlight: 3 COB LED lights module
LIGHT OUTPUT	Headlight: 60 lm ± 20% / backlight: 4 lm ± 20%
LUMINANCE	Headlight: 8 lx / 10 m / backlight: 6 cd ± 20%
POWER SOURCE	Headlight: AA battery / backlight: AAA battery
OPERATING TIME	Headlight ≥ 7 h / backlight ≥ 21 h
OPERATING MODES	Constant Intermittent
FEATURES	Tool-free mounting IPX4 water resistance All-purpose mounting bracket
DIMENSIONS	Headlight: 83 x 34 x 40 mm Backlight: 65 x 25 x 22 mm
WEIGHT	57 g (including bracket)

T4COS000080



TRIANGLE SET

Triangle Set is a set of very bright and compact bicycle lights. 75 lumens ensure visibility in any weather conditions. The modern design makes them a great addition to any bicycle. A special built-in battery level indicator will let you know when it's time to charge the built-in battery. and the long operating time will keep you safe during every ride. The sealed casing protects the light against water penetration, enabling use in difficult weather conditions.

LIGHTING TYPE	Emergency (complementary)
MATERIAL	ABS / PC
ATTACHMENT LOCATION	Handlebars / seatpost
MOUNTING SYSTEM	Rubber O-ring
LIGHT SOURCE	Headlight / backlight 18 LEDs on a COB platform
LIGHT OUTPUT	Headlight / backlight: 75 lm
POWER SOURCE	Headlight / backlight: 260 mAh lithium batteries
OPERATING TIME	1.5-6 h
CHARGING TIME	± 3 h
OPERATING MODES	Constant - 3 Intermittent - 3
FEATURES	Battery level indicator Tool-free mounting IPX4 water resistance All-purpose mounting bracket
DIMENSIONS	Headlight: 43 x 41 x 21 mm Backlight: 43 x 41 x 21 mm
WEIGHT	68.4 g (including brackets)

T4COS000083



LUMI SET II

A practical set of two lights in cases made of plastic and silicone. Both the head- and the backlight feature 3 LED lights to guarantee long service life. The convenient mounting system allows you to use the lights with different bikes.

LIGHTING TYPE	Main light
MATERIAL	ABS / PC / silicone
ATTACHMENT LOCATION	Handlebars / seatpost
MOUNTING SYSTEM	Silicone clasp
LIGHT SOURCE	Headlight: 3 0.5 W LED lights / backlight: 3 LED lights
LUMINANCE	Headlight: 2.3 lx / 10 m / backlight: 2 cd
LIGHT OUTPUT	Headlight: 22 lm / backlight: 3 lm
LIGHT TEMPERATURE	6000-8000 K
POWER SOURCE	Headlight: 3 AAA batteries / backlight: 2 CR2032 batteries
OPERATING MODE	Constant Intermittent
FEATURES	Tool-free mounting and removal IPX4 water resistance
DIMENSIONS	Headlight: 82 x 49 x 74 mm Backlight: 68 x 43 x 38 mm
WEIGHT	58 g (including brackets)

T4COS000079BK black



SILICONE 2

Ultralight safety lighting set made of silicone. Both the front and rear-light are equipped with LEDs, ensuring high service life. Different operating modes allow you to choose the type of light. An easy way to mount allows you to use lighting on different types of bikes.

MATERIAL	Silicone
MOUNTING LOCATION	Handlebars / seatpost
FASTENING	Silicone clamp
LIGHT SOURCE	2 LEDs
LUMINOUS INTENSITY	Front: 2.5 cd / rear: 1.4 cd
LIGHT POWER	Front: 15 lm / rear: 5 lm
POWER SOURCE	4 CR2032 batteries (included)
OPERATING MODE	Constant Blinking
FEATURES	Tool-free mounting and removal IPX4 water resistance
WEIGHT	52 g

T4COS000081

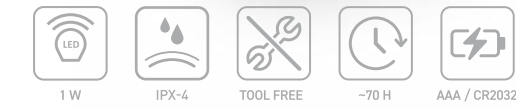

SUN-UP SET

Sun-up is a practical set of two lights in cases made of plastic and silicone, that can be easily attached to your bike. The headlight features a 1 W LED that will properly illuminate the way ahead of you. The backlight equipped with 2 ultra bright LEDs of excellent service life will keep you perfectly visible to others. The convenient mounting system allows you to use the lights with different bikes.

LIGHTING TYPE	Main light
MATERIAL	PC / Silicone
ATTACHMENT LOCATION	Handlebars / seatpost
MOUNTING SYSTEM	Silicone clasp
LIGHT SOURCE	Headlight: 1 W LED / backlight: 2 super bright LED lights
LUMINANCE	Headlight: 8 lx / 10 m / backlight: 2 cd
POWER SOURCE	Headlight: 3 AAA batteries / backlight: 2 CR2032 batteries
OPERATING TIME	Headlight: 40 h / backlight: 120 h
OPERATING MODE	Constant Intermittent
FEATURES	Tool-free mounting IPX4 water resistance
DIMENSIONS	Headlight: 89 x 35 x 40 mm Backlight: 37 x 33 x 35 mm
WEIGHT	93 g (including brackets)

T4COS000076



BLINK SET

A lightweight set of two bicycle lights in plastic cases. The light is provided by 15 LEDs on a COB platform. The intuitive mounting system allows you to quickly move the light to another bike. The sealed casing protects the light against water penetration, enabling use in difficult weather conditions.

LIGHTING TYPE	Emergency (complementary)
MATERIAL	PC
ATTACHMENT LOCATION	Handlebars / seatpost
MOUNTING SYSTEM	Rubber clasp
LIGHT OUTPUT	Headlight / backlight: 15 COB LEDs COB
LUMINANCE	Headlight: 2.3 lx / 10 m / backlight: 2 cd
LUMINANCE	Headlight 1 lx / 2 m / backlight 0.5 lx / 2 m
LIGHT OUTPUT	Headlight 15 lm / backlight 5 lm
POWER SOURCE	4 x CR2032
OPERATING TIME	≥ 4 h
OPERATING MODE	Constant Intermittent
FEATURES	All-purpose mounting bracket Tool-free mounting and removal IPX4 water resistance
DIMENSIONS	Headlight: 55 x 28 x 17 mm Backlight: 55 x 28 x 17 mm
WEIGHT	70 g (including brackets)

T4COS000082



EASY SET

Easy is a set that includes a headlight and a backlight powered by CR2032 batteries. The compact lights are bright enough to keep you visible in traffic. Silicone straps for quick mounting and removal. Easy to store due to compact size.

LIGHTING TYPE	Emergency (complementary)
MATERIAL	PC / Silicone
ATTACHMENT LOCATION	Handlebars / seatpost
MOUNTING SYSTEM	Silicone clasp
LIGHT SOURCE	Headlight: 2 LED lights / backlight: 2 super bright LED lights
POWER SOURCE	Headlight / backlight: 2 CR2032 batteries
OPERATING TIME	Headlight: 40 h / backlight: 120 h
OPERATING MODE	Constant Intermittent
FEATURES	Tool-free mounting and removal IPX4 water resistance
DIMENSIONS	Headlight: 55 x 28 x 17 mm Backlight: 55 x 28 x 17 mm
WEIGHT	62 g

T4COS000077



EASY&SAVE

The sophisticated structure of the bracket ensures a stable position of the phone and prevents it from slipping out of the bracket during your ride. Silicone, shock absorbing pads keep the phone stable in the bracket, while special edging protects the casing from scratches. The rotating panel allows you to use the phone in a vertical or horizontal position. You can easily put the phone in and out of the bracket. Can be used for smartphones with 4-6.5" screen sizes.

MATERIAL	PPS / GF40
ATTACHMENT LOCATION	Handlebars
COMPATIBILITY	Smartphones with 4-6.5" screen sizes
FEATURES	Robust and safe corners Anti-slip base Scratch protection Quick assembly and disassembly Rotating panel
DIMENSIONS	157 x 74 x 86 mm
WEIGHT	132 g

T4CIN000023

ACCESSORIES

BOTTLES & BOTTLE CAGES





ESKER THERMAL

This flask is a proof that simple solutions are the ones that work best. The most important feature of ESKER THERMAL flask is the ability to maintain temperature for 3 to 4 hours. When you remove the thermal core of 500 ml capacity, the flask turns into a standard 650 ml water bottle.

MATERIAL	Non-toxic plastic
CAPACITY	650 ml / 500 ml
WEIGHT	156 g / 98 g

T4CB1000077BK	black
T4CB1000077BKRD	black / red
T4CB1000077WH	white



ENVIRONMENT FRIENDLY

Environment Friendly bottle is made of 100% biobased material from sugarcane. This way of making bio polyethylene products is much better for our environment, the sugarcane grows, it removes CO₂ from the air. The whole composting process in a landfill takes about one to five years. At the correct temperature, the bio-batch additive activates and the bottle decomposes into water, humus and gas. The bottle is equipped with a special silicone cap, which prevents spilling even when you hold the bottle upside down.

MATERIAL	Biodegradable, non-toxic plastic
CAPACITY	500 ml
WEIGHT	77 g

T4CB1000078BK	black
T4CB1000079TR	transparent





TEAM EDITION 750ML

This water bottle was designed for professional riders who look for the highest workmanship and functionality. TEAM EDITION water bottles feature silicone self-closing caps that dose the liquid as needed. Made of plastic, without any harmful compounds added (BPA FREE). Developed in collaboration with KROSS ORLEN Cycling Team members.

MATERIAL	Non-toxic plastic
CAPACITY	750 ml
WEIGHT	95 g

T4CBI000086BK	black
T4CBI000086RD	red



TEAM EDITION 500ML

This water bottle was designed for professional riders who look for the highest workmanship and functionality. TEAM EDITION water bottles feature silicone self-closing caps that dose the liquid as needed. Made of plastic, without any harmful compounds added (BPA FREE). Developed in collaboration with KROSS ORLEN Cycling Team members.

MATERIAL	Non-toxic plastic
CAPACITY	500 ml
WEIGHT	77 g

T4CBI000085BK	black
----------------------	-------



PURE 750ML

A classic water bottle made of plastic, without any harmful compounds added (BPA FREE). Features a standard cap with lock to prevent any leakage when you carry it in your backpack. The refined shape of the cap ensures convenient operation from the very first use.

MATERIAL	Non-toxic plastic
CAPACITY	750 ml
WEIGHT	95 g

T4CBI000080BL	blue
T4CBI000082GY	grey
T4CBI000082RD	red
T4CBI000082TR	transparent



PURE 500ML

A classic water bottle made of plastic, without any harmful compounds added (BPA FREE). Features a standard cap with lock to prevent any leakage when you carry it in your backpack. The refined shape of the cap ensures convenient operation from the very first use.

MATERIAL	Non-toxic plastic
CAPACITY	500 ml
WEIGHT	77 g

T4CB1000084BL	blue
T4CB1000084BLK	black
T4CB1000084CL	transparent
T4CB1000084DBL	dark blue
T4CB1000084DGR	dark green
T4CB1000084GY	grey
T4CB1000084RD	red
T4CB1000084TR	transparent
T4CB1000084YL	yellow



RACE PRO

A bottle cage made of nylon combined with carbon fiber. Highly flexible and durable at the same time, despite its light weight of only 17 grams.

MATERIAL	Nylon / Composite fiber
WEIGHT	17 g

T4CKZBI0078BK	black
T4CKZBI0078BKWH	black / white



PRO ONE

A bottle cage made of nylon combined with carbon fiber. Highly flexible and durable at the same time, despite its light weight of only 19 grams.

MATERIAL	Nylon / Composite fiber
WEIGHT	19 g

T4CKZBI0072BK	black
T4CKZBI0072BL	blue
T4CKZBI0072RD	red
T4CKZBI0072WH	white



SPORT SIDEPULL

This bottle cage features a unique construction: thanks to the side opening it ensures easy access to the water bottle w with small frames and bicycles with full suspension. Can be mounted with access from the right or left side.

MATERIAL	Plastic
WEIGHT	44 g

T4CKZBI0079BK	black
T4CKZBI0079BL	black
T4CKZBI0079RD	black



CLAW II

A lightweight bottle cage made of flexible plastic. Two high-quality stainless steel screws are included in the set.

MATERIAL	Plastic
WEIGHT	34 g

T4CKZBI0076BK	black
T4CKZBI0076BL	blue
T4CKZBI0076DGR	green
T4CKZBI0076RD	red



PRO TWO

A bottle cage made of flexible plastic. Offers an attractive design and light weight (only 30 g). Two high-quality steel screws are included in the set.

MATERIAL	Plastic
WEIGHT	30 g

T4CKZBI0080BK	black
T4CKZBI0080BL	black / blue
T4CKZBI0080RD	black / red
T4CKZBI0080WH	black / white



PRO

A lightweight bottle cage made of flexible plastic. The flexibility makes it easier to use your bottle during riding. Two high-quality stainless steel screws are included in the set.

MATERIAL	Plastic
WEIGHT	28 g

T4CKZBI0081BK	black
T4CKZBI0081BL	blue
T4CKZBI0081GY	grey
T4CKZBI0081RD	red

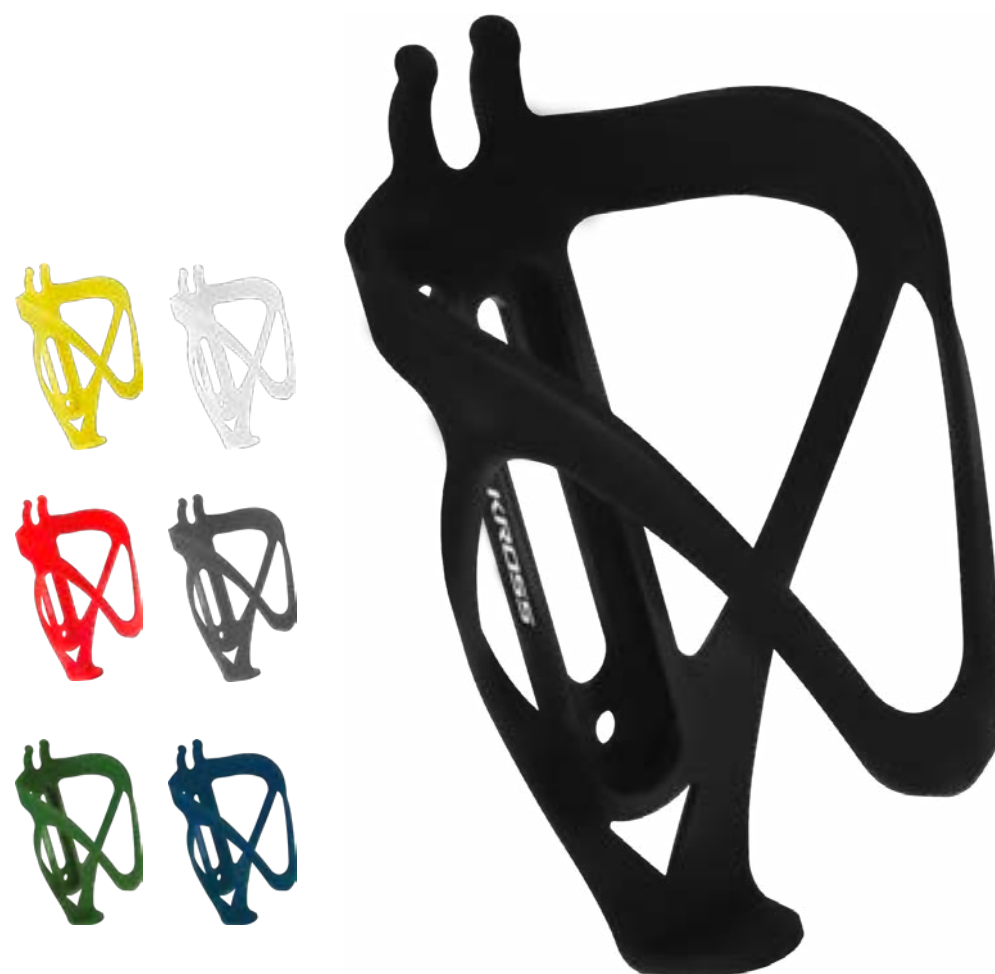

GRID

A lightweight bottle cage that was made of flexible plastic. The sophisticated shape ensures easy access and a firm grip of the bottle. Two high-quality stainless steel screws are included in the set.

MATERIAL	Plastic
WEIGHT	33 g

T4CKZBI0082BK	black
T4CKZBI0082LBL	blue
T4CKZBI0082DGR	dark green
T4CKZBI0082GY	grey
T4CKZBI0082TQ	blue-green
T4CKZBI0082RD	red
T4CKZBI0082WH	white
T4CKZBI0082YL	yellow



CART

A classic bottle cage made of aluminum. Ensures a firm grip and easily adjusts to water bottles of various sizes. Two high-quality steel screws are included in the set.

MATERIAL	Aluminum
WEIGHT	65 g

T4CKZBI0071BK	black
T4CKZBI0071BL	blue
T4CKZBI0071GP	bullet grey
T4CKZBI0071RD	red
T4CKZBI0071SI	silver
T4CKZBI0071WH	white

ACCESSORIES

TOOLS





SMOOTH 17

A professional and compact set of tools is an indispensable piece of equipment for every cyclist. A light 17-in-1 multi-function tool has all you need to quickly service your bike. Handy both in your home garage and for an out of town training. Useful when you need to lift the handlebar support or repair a broken chain. Both the tools and the case are made of high-quality stainless hardened chromium-vanadium (CR-V) steel.

MATERIAL	CR-V steel
FUNCTIONS	17
TOOL TYPES	
	Torx T25
	Hex wrench 2/2.5/3/4/5/6/8 mm
	Flat screwdriver SL5
	Phillips screwdriver PH2/PH1
	Chain breaker 9/10/11 speed
	Spoke key SHIMANO 4.3/4.4/Hex 4.6/MAVIC M7
	Bottle opener

T4CKU000164



SMOOTH 12

A professional and compact set of tools is an indispensable piece of equipment for every cyclist. A light 12-in-1 multi-function tool has all you need to quickly service your bike. Handy both in your home garage and for an out of town training. Useful when you need to lift the handlebar support or adjust the gears. Both the tools and the case are made of high-quality stainless hardened chromium-vanadium (CR-V) steel.

MATERIAL	CR-V steel
FUNCTIONS	12
TOOL TYPES	
	Hex wrench 2/2.5/3/4/5/6/8 mm
	Phillips screwdriver PH1/PH2
	Flat screwdriver SL5
	Torx® T25/T15

T4CKU000148





SMOOTH 6

A professional and compact set of tools is an indispensable piece of equipment for every cyclist. A light 6-in-1 multi-function tool has all you need to quickly service your bike. Handy both in your home garage and for an out of town training. Useful when you need to lift the handlebar support or adjust the gears. Both the tools and the case are made of high-quality stainless hardened chromium-vanadium (CR-V) steel.

MATERIAL	CR-V steel
FUNCTIONS	6
TOOL TYPES	Hex wrench 3/4/5/6 mm Phillips screwdriver PH1 Torx® T25

T4CKU000150



SMART 10

A multi-function tool is an indispensable piece of equipment for every cyclist. A light 10-in-1 multi-function tool has all you need to quickly service your bike. Handy both in your home garage and for an out of town training. Useful when you need to lift the handlebar support or adjust the gears. Tools are made of high-quality chromium-vanadium (CR-V) steel.

MATERIAL	CR-V steel
FUNCTIONS	10
TOOL TYPES	Hex wrench 2/2.5/3/4/5/6/8 mm Flat screwdriver 5/ Phillips screwdriver PH2 Torx® T25

T4CKU000161



SMART 8

This multi-function tool is an indispensable piece of equipment for every cyclist. A light 8-in-1 multi-function tool has all you need to quickly service your bike. Handy both in your home garage and for an out of town training. Useful when you need to lift the handlebar support or adjust the gears. Tools are made of high-quality chromium-vanadium (CR-V) steel.

MATERIAL	CR-V steel
FUNCTIONS	8
TOOL TYPES	Hex wrench 2/3/4/5/6/8 mm FLAT 5 screwdriver Torx® T25

T4CKU000162



SMART 6

This multi-function tool is an indispensable piece of equipment for every cyclist. A light 6-in-1 multi-function tool has all you need to quickly service your bike. Handy both in your home garage and for an out of town training. Useful when you need to lift the handlebar support or adjust the gears. Tools are made of high-quality chromium-vanadium (CR-V) steel.

MATERIAL	CR-V steel
FUNCTIONS	6
TOOL TYPES	Hex wrench 3/4/5/6 mm Phillips screwdriver PH1 Torx® T25

T4CKU000163



FLATTY

Service wrench for assembling and disassembling bicycle pedals. The tool part is made of steel, with a PVC handle. Equipped with two 15 mm wrenches (a flat and a socketed one) and 2 hex wrenches (6 mm and 8 mm). The finishing of the wrench ensures durability, resistance to damage and working precision.

MATERIAL	STEEL, PVC
FUNCTIONS	4
TOOL TYPES	Two 15 mm wrenches: a flat and a socketed one Hex wrench: 6/8 mm

T4CKU000166



CRAB II

Ergonomic handle made of ABS polyethylene for a more comfortable grip. The double replaceable tip ensures longer life of the tool and its reliability. All-purpose, for IG / HG / UG chains.

MATERIAL	Steel, ABS polyethylene
INTENDED	for IG / HG / UG chains

T4CKU000145

ACCESSORIES

PUMPS





BURAN TUBELESS MANO

SERVICE
PUMP



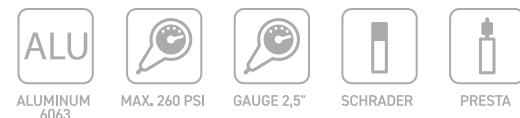

BURAN

A high-quality service pump with a compressor function that allows the insertion of tubeless tires. Thanks to the integrated compressor, it is easy to pump tubeless tires. Features an easy-to-read 2.5" pressure gauge at the top. Intuitive to use. Due to the large cylinder volume, pumping is very efficient. New, double head for all types of valves, equipped with an easy-to-use lock.

MATERIAL	6063 aluminum cylinder, steel compressor
SUPPORTED VALVES	Presta, Schrader, Dunlop
MAX PRESSURE	260 PSI
ADDITIONAL INFORMATION	<ul style="list-style-type: none"> 2.5-inch pressure gauge located at the top of the pump Stable steel base, finished with non-slip rubber 2-mode operation Tank - air compression Tire - inflating / embedding a tubeless tire in the rim Clever Twin smart valve
HEIGHT	68 cm
WEIGHT	1.967 kg

T4CPO000142



HURRICANE

Professional steel pump equipped with a precision pressure gauge located on top. Allows you to reach very high pressure values. Due to the large cylinder volume, pumping is very efficient. New, double head for all types of valves, equipped with an easy-to-use lock.

MATERIAL	Steel, reinforced plastic
SUPPORTED VALVES	Presta, Schrader, Dunlop
MAX PRESSURE	160 PSI
ADDITIONAL INFORMATION	<ul style="list-style-type: none"> 2.5-inch pressure gauge located at the top of the pump Durable steel cylinder Stable steel base Ergonomic 2-tone handle Twin-Valve with a lock
HEIGHT	66 cm
WEIGHT	1.637 kg

T4CPO000140



SKEIRON II

A lightweight pump intended for shock absorbers and air dampers. Easily reaches all hard-to-reach areas thanks to the flexible and rotating hose. Lock ferrule on the valve facilitates inflation. The built-in pressure gauge lets you control pressure with ease, and the pressure relief valve helps to adjust it.

MATERIAL	Aluminum, plastic
SUPPORTED VALVES	Schrader
MAX PRESSURE	300 PSI
ADDITIONAL INFORMATION	<ul style="list-style-type: none"> Intended for shock absorbers and dampers Cylinder and piston made of high-quality aluminum Pressure relief valve for precise pressure control (2-3 PSI) Precision pressure gauge (21 bar / 300 psi) Flexible hose Rotating head Locking lever Compact size Ergonomic handle Schrader valve tip
LENGTH	28.4 cm
WEIGHT	200 g

T4CPO000146



TORNADO

Durable service pump, equipped with a precision pressure gauge. Allows you to reach very high pressure values. Due to the large cylinder volume, pumping is very efficient.

MATERIAL	6063 aluminum
SUPPORTED VALVES	Presta, Schrader, Dunlop
MAX PRESSURE	160 PSI
ADDITIONAL INFORMATION	Easy-to-read pressure gauge
	Locking lever
	Ergonomic handle
HEIGHT	61 cm
WEIGHT	880 g

T4CPO000144



STORM

Service pump that enables you to reach very high pressure values. Due to the large cylinder volume, pumping is very efficient.

MATERIAL	Reinforced plastic
SUPPORTED VALVES	Presta, Schrader, Dunlop
MAX PRESSURE	160 PSI
ADDITIONAL INFORMATION	Locking lever
	Ergonomic handle
HEIGHT	61 cm
WEIGHT	710 g

T4CPO000145



MATAGI

Lightweight telescopic pump that can accompany you during every trip. It can be attached in the bottle cage spot, so that it's easy to carry it around. Lock ferrule on the valve facilitates inflation. The built-in pressure gauge allows you to control the tire pressure. T-handle makes the pumping process more comfortable.

MATERIAL	Aluminum
SUPPORTED VALVES	Presta, Schrader, Dunlop
MAX PRESSURE	120 PSI
ATTACHMENT	Bracket attached to the bottle cage holes
ADDITIONAL INFORMATION	Pressure gauge
	Special reclining T-handle
	Locking lever
LENGTH	27 cm
WEIGHT	165 g

T4CPO000149

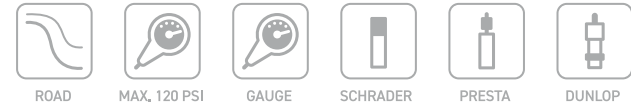

HVG 4.0

Universal pump with extractable hose, equipped with a precision pressure gauge. Made of reinforced plastic and aluminum. The HP (High Pressure) construction is suitable for tires that require high pressure values. Works with any valve (replacing the head valve required). Extractable hose improves comfort while pumping. Fitted with a cover that protects the valve from dust.

MATERIAL	Aluminum, plastic
SUPPORTED VALVES	Presta, Schrader, Dunlop
MAX PRESSURE	120 PSI
ATTACHMENT	Bracket attached to the bottle cage holes in the frame
ADDITIONAL INFORMATION	Precision pressure gauge Dust protection cover Extractable hose
LENGTH	26.6 cm
WEIGHT	143 g

T4CPO000139



HP 4.0

All-purpose mini pump with extractable hose. Made of reinforced plastic and aluminum. The HP (High Pressure) construction is suitable for tires that require high pressure values. Works with any valve (replacing the head valve required). Extractable hose improves comfort while pumping. Fitted with a cover that protects the valve from dust.

MATERIAL	Aluminum, plastic
SUPPORTED VALVES	Presta, Schrader, Dunlop
MAX PRESSURE	100 PSI
ATTACHMENT	Bracket attached to the bottle cage holes in the frame
ADDITIONAL INFORMATION	Dust protection cover Extractable hose
LENGTH	22.4 cm
WEIGHT	60 g

T4CPO000150

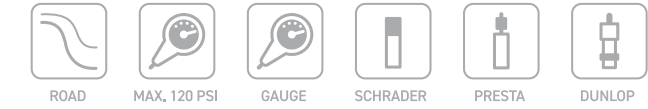

HPG 2.0

Universal pump with extractable hose, equipped with a precision pressure gauge. Made of reinforced plastic. The HP (High Pressure) construction is suitable for tires that require high pressure values. Works with any valve (replacing the head valve required). Extractable hose improves comfort while pumping. Fitted with a cover that protects the valve from dust.

MATERIAL	Plastic
SUPPORTED VALVES	Presta, Schrader, Dunlop
MAX PRESSURE	120 PSI
ATTACHMENT	Bracket attached to the bottle cage holes in the frame
ADDITIONAL INFORMATION	Precision pressure gauge Dust protection cover Extractable hose
LENGTH	26.2 cm
WEIGHT	109 g

T4CPO000137



AQUILO

Lightweight pump that can accompany you during every trip. It can be attached in the bottle cage spot, so that it's easy to carry it around. Lock ferrule on the valve facilitates inflation. T-handle makes the pumping process more comfortable. Fitted with a cover that protects the valve from dust.

MATERIAL	Aluminum, reinforced plastic
SUPPORTED VALVES	Presta, Schrader, Dunlop
MAX PRESSURE	100 PSI
ATTACHMENT	Bracket attached to the bottle cage holes
ADDITIONAL INFORMATION	Special reclining T-handle Locking lever Dust protection cover
LENGTH	22.4 cm
WEIGHT	130 g

T4CPO000151



HP 2.0

All-purpose mini pump with extractable hose. Made of reinforced plastic. The HP (High Pressure) construction is suitable for tires that require high pressure values. Works with any valve (replacing the head valve required). Extractable hose improves comfort while pumping. Fitted with a cover that protects the valve from dust.

MATERIAL	Plastic
SUPPORTED VALVES	Presta, Schrader, Dunlop
MAX PRESSURE	100 PSI
ATTACHMENT	Bracket attached to the bottle cage holes in the frame
ADDITIONAL INFORMATION	Dust protection cover Extractable hose
LENGTH	22.2 cm
WEIGHT	60 g

T4CPO000152



HAMMERHEAD 2.0

An all-purpose and compact pump at an affordable price. Handy for all cyclists in need during a ride, as well as for periodic bicycle inspections. Thanks to the double pumping valve it is suitable both for Schröder and presto valves. The pump comes with a mounting bracket for standard holes, such as those used for bottle cages.

MATERIAL	Plastic
SUPPORTED VALVES	Presta, Schrader, Dunlop
MAX PRESSURE	100 PSI
ATTACHMENT	Bracket attached to the bottle cage holes
ADDITIONAL INFORMATION	Locking lever Frame mounting bracket Ergonomic, soft handle
LENGTH	25.5 cm
WEIGHT	112 g

T4CPO000157



CLEAR SHOT

A compact and lightweight pump, useful both for city riding and off-road trips. Made of an aluminum alloy to ensure reliability and durability. The pump handle has an ergonomic shape to make it easier to use it. Mounting bracket included. The pump is so compact that it can be attached to the bicycle frame or simply carried in your backpack pocket. Thanks to the smart CLEAR SHOT head, it can pump any valve, with no head changes required. Mounting bracket included.

MATERIAL	6063 aluminum
SUPPORTED VALVES	Presta, Schrader, Dunlop
MAX PRESSURE	120 PSI
ATTACHMENT	Bracket attached to the bottle cage holes
ADDITIONAL INFORMATION	Clever Valve Locking lever Ergonomic handle
LENGTH	25.5 cm
WEIGHT	140 g

T4CPO000158



WASP

Extremely lightweight pump that can accompany you during every trip. It can be attached in the bottle cage spot, so that it's easy to carry it around. Lock ferrule on the valve facilitates inflation. The pump features a container, where you can put e.g. a set of patches to make it a fully functional repair kit.

MATERIAL	Reinforced plastic
SUPPORTED VALVES	Presta, Schrader, Dunlop
MAX PRESSURE	80 PSI
ATTACHMENT	Bracket attached to the bottle cage holes
ADDITIONAL INFORMATION	Extra room for tools or tube repair set Locking lever
LENGTH	25.6 cm
WEIGHT	76 g

T4CPO000154



BUCCA

Lightweight pump that can accompany you during every trip. You can attach it to a rack equipped with a compatible bracket. Compatible with different valve types.

MATERIAL	Plastic
SUPPORTED VALVES	Presta, Schrader, Dunlop
MAX PRESSURE	80 PSI
ATTACHMENT	To racks equipped with pump brackets (235 mm)
LENGTH	25.3 cm
WEIGHT	99 g

T4CPO000155



HORNET

Extremely lightweight pump that should accompany you during every trip. It can be attached in the bottle cage spot, so that it's easy to carry it around. The pump features a container, where you can put e.g. a set of patches to make it a fully functional repair kit.

MATERIAL	Reinforced plastic
VALVES	Presta, Schrader, Dunlop
MAX PRESSURE	80 PSI
ATTACHMENT	Bracket attached to the bottle cage holes
ADDITIONAL INFORMATION	Extra room for tools or tube repair set
LENGTH	23.3 cm
WEIGHT	60 g

T4CPO000156



HP 1.0

A lightweight pump that can become a companion to any trip. Fastening at the place of the bottle makes it easy to carry it. Lock ferrule on the valve makes inflation very easy. Equipped with a protective cover that protects the valve from dust.

MATERIAL	Reinforced plastic composite
VALVES	Presta, Schrader, Dunlop
MAX PRESSURE	120 PSI
ATTACHMENT	Bracket attached to the bottle cage holes
ADDITIONAL INFORMATION	Frame mounting bracket
	Velcro strap
	Locking lever
	Dust cover
WEIGHT	70 g

T4CPO000153



ACCESSORIES

LOCKS



ULOCK KZU 350

SECURITY LVL 11





NEW

eKZU 430

Smart Ulock, eKZU 430, is made from hardened steel, and the housing of its lock is made from aluminium and ABS alloy. The steel used to make this protection is resistant to corrosion, wear as well as cutting. The IP67 sealing rating guarantees resistance to immersion in water (for up to 30 minutes), and it is fully dustproof. A sliding cover protects it from most weather conditions. The lock is equipped with a fingerprint reader, which enables quick opening. It can also be unlocked using an easy-to-use app paired with the lock. You no longer have to worry about lost keys or forgotten codes, it uses your unique fingerprint to control access. The lock memory can store up to 10 different fingerprints, so you can share your bike with family members or friends. It is a safe and convenient way to protect your bike. The built-in 500 mAh lithium-ion battery can be charged by a portable Powerbank. You do not have to worry about replacing the battery as one charge is enough to keep the lock on standby for two years or allow 2,000 unlocks. When the battery is discharged, the lock can be opened with the key supplied.

BODY MATERIAL	Hardened steel / housing made of aluminium and ABS
PROTECTION LEVEL	11 on the Kross scale
LOCK TYPE	Key, fingerprint, app (TTLock)
SHACKLE DIMENSIONS	97 x 167 mm
DIAMETER	12.5 mm
WEIGHT	1.150 kg
ADDITIONAL INFORMATION	Connection: BLE 5.0 AES 128 connection encryption with an anti-theft alarm Supported devices: IOS 7.0 / Android 4.3 or later TTLock app downloadable from Google Store and App Store Battery: 3.7 V / 500 mAh lithium-polymer Charging port: USB Type-C Waterproof rating: IP67 Increased protection against: cutting Includes: a set of holders, 2 keys, a charging cable

T4CZP000272



ULTRA 410

The simple, sturdy and aggressive construction is a perfect match for this U-lock. Ultra 410 is a minimalist product that features many advanced safety solutions. The 12 mm shackle is made of hardened steel and, as seen in the SUPER ULTIMATE 430 and ULTIMATE 420 models, it runs along the entire length of the lock body. Locked on both sides with the use of steel bolts for added protection against attacks such as twisting, bending and cutting. The ULTRA 410 model features a soft plastic casing to protect the paint from scratches. Just like all ABUS locks, it offers a high resistance to rust.

BODY MATERIAL	Hardened steel with a plastic outer shell.
PROTECTION LEVEL	7 in the ABUS scale
LOCK TYPE	Key
SHACKLE DIMENSIONS	108 mm x 230 mm
DIAMETER	12 mm
WEIGHT	1.09 kg
ADDITIONAL INFORMATION	2 keys included

T4CZP000205BK

green



ULTIMATE 420

ULTIMATE 420 combines many advantages of its older siblings. Similarly to the Super Ultimate 430 model, the shackle runs along the entire body and is locked on both sides with the use of steel bolts for increased protection against twisting and bending. For better protection against cutting, crushing and bending, the shackle, that is a bit narrower than in the SUPER ULTIMATE 430 model, as long as the body and other important metal elements are made of hardened steel. The ULTIMATE 420 model features a soft plastic casing to protect the paint from scratches. Just like all ABUS locks, it offers a high resistance to rust.

BODY MATERIAL	Hardened steel with a plastic outer shell.
PROTECTION LEVEL	9 in the ABUS scale
LOCK TYPE	Key
SHACKLE DIMENSIONS	108 mm x 230 mm
DIAMETER	14 mm
WEIGHT	1.681 kg
ADDITIONAL INFORMATION	2 keys included

T4CZP000204BK

red



KZU 370

A solid U-Lock with key lock. Made of hardened steel with plastic casing to protect the frame against scratches. The hardened steel, with its higher resistance to cutting, crushing and bending, provides even better bike protection. The lock can be keyed from both sides.

BODY MATERIAL	Hardened steel with a plastic outer shell.
PROTECTION LEVEL	12 in the Kross scale.
LOCK TYPE	Key
DIMENSIONS	180 mm x 320 mm
DIAMETER	16 mm
WEIGHT	1.74 kg
ADDITIONAL INFORMATION	3 keys included

T4CZP000237



KZU 350

A solid U-Lock with key lock. Made of hardened steel with plastic cover to protect the frame against scratches. The hardened steel, with its higher resistance to cutting, crushing and bending, provides even better bike protection. The lock can be keyed from both sides.

BODY MATERIAL	Hardened steel with a plastic outer shell.
PROTECTION LEVEL	11 in the Kross scale.
LOCK TYPE	Key
DIMENSIONS	180 mm x 320 mm
DIAMETER	13 mm
WEIGHT	1.310 kg
ADDITIONAL INFORMATION	3 keys included

T4CZP000198



KZU 360

A sturdy U-Lock with key lock. Made of hardened steel with plastic cover to protect the frame against scratches. The hardened steel, with its higher resistance to cutting, crushing and bending, provides even better bike protection. The lock can be keyed from both sides.

BODY MATERIAL	Hardened steel with a plastic outer shell.
PROTECTION LEVEL	8 in the Kross scale.
LOCK TYPE	Key
DIMENSIONS	180 mm x 320 mm
DIAMETER	13 mm
WEIGHT	1.272 kg
ADDITIONAL INFORMATION	2 keys included

T4CZP000238



NEW

eKZF 550

The eKZF 550 lock is the best friend of anyone who frequently cycles through the urban jungle. It uses advanced BT 5.0 communication technology, offers proactive protection, and is also convenient to transport as you can easily fold it. It is made from highly cut-resistant alloy steel and its IP67 waterproof rating ensures it is well protected against water and dust. eKZF 550 has a built-in motion sensor that will send app alerts via Bluetooth to the smartphone paired with it as soon as someone starts tampering with your bike. Using the installed application, the lock can be detected in an open area within a 50-metre radius of the phone tracking it. The app connects to the lock via Bluetooth 5.0 and detects remote control of the lock via an encrypted connection. When the battery runs out, the lock can be opened with the standard key supplied. With the app, you can easily find the location of your secured bike as it is marked every time you lock it. The built-in high-performance lithium battery and low-power components provide long-lasting protection for more than a month after a full charge. The lock provides the highest level of bicycle safety.

MATERIAL	Reinforced steel
PROTECTION LEVEL	11 on the Kross scale
LOCK TYPE	Key, fingerprint, app (TTLock)
PANEL THICKNESS	5 mm / 6.35 mm
WEIGHT	1.65 kg
ADDITIONAL INFORMATION	Connection: BLE 5.0 AES 128 connection encryption with an anti-theft alarm Supported devices: iOS 10.0c / Android 6.0 or later TTLock app downloadable from Google Store and App Store Battery: 3.7 V 640 mAh lithium-polymer Charging port: USB Type-C Waterproof rating: IP67 Increased protection against sawing, drilling, cutting, and brute force attacks Includes: a holder, 2 keys, a charging cable

T4CZP000273



NEW

KZF 450

The KZF 450 folding lock is made from 5 mm thick steel panels finished with soft plastic, protecting the paintwork of the bike against scratches. The joint design enables convenient and easy folding and transport, and allows the links to rotate smoothly on the axis without jamming or creaking. The rivet protection effectively strengthens sensitive areas, ensuring the highest level of safety. The easy mounting system enables easy attachment to a variety of bike frames. A high-quality lock provides very good protection against tampering. Two keys, one lock holder, and two cable ties included.

MATERIAL	Hardened 20CrMnTi steel alloy
PROTECTION LEVEL	12 on the Kross scale
LOCK TYPE	Key
PANEL THICKNESS	5 mm
WEIGHT	0.92 kg
ADDITIONAL INFORMATION	Anti-theft insert of Swiss design Increased protection against sawing, drilling, cutting, and the so-called brute force attacks Two keys, one lock holder, and two ties included The key can be duplicated according to the code on the key

T4CZP000270



NEW

KZF 440

The KZF 440 folding lock is made from 5 mm thick steel panels finished with soft plastic, protecting the paintwork of the bike against scratches. The joint design enables convenient and easy folding and transport, and allows the links to rotate smoothly on the axis without jamming or creaking. The rivet protection effectively strengthens sensitive areas, ensuring the highest level of safety. The easy mounting system enables easy attachment to a variety of bike frames. A high-quality lock provides very good protection against tampering. Two keys, one lock holder, and two cable ties included.

MATERIAL	Hardened high-carbon steel
PROTECTION LEVEL	10 on the Kross scale
LOCK TYPE	Key
PANEL THICKNESS	5 mm
WEIGHT	0.91 kg
ADDITIONAL INFORMATION	Anti-theft insert of Swiss design Increased protection against sawing, drilling, cutting, and the so-called brute force attacks Two keys, one lock holder, and two ties included The key can be duplicated according to the code on the key

T4CZP000271



KZF 300

Keyed folding bike lock. Composed of steel panels of 5 mm thickness, covered with a soft plastic coating that protects the bicycle paint from scratches. The joint construction helps to fold the lock conveniently for easy transport. An ergonomic case made of a soft plastic material. Easy-mount system allows to easily attach it to various bicycle frames. A high-class lock ensures good protection against tampering. Two keys included.

MATERIAL	Hardened steel with a plastic casing.
PROTECTION LEVEL	8 in the KROSS scale
LOCK TYPE	Key
PANEL THICKNESS	5 mm
LENGTH	85 cm
WEIGHT	0.78 kg
ADDITIONAL INFORMATION	2 keys included

T4CZP000239



KZL 650

A chain with 10 mm links with square cross-section in a fabric protective sleeve. The chain, body and the lock are made of specially reinforced and hardened steel. The padlock is covered with a soft plastic material that ensures protection against scratches and impacts. The padlock can be keyed from both sides and its shape hinders attacks with the use of heavy objects.

MATERIAL	Reinforced hardened steel.
PROTECTION LEVEL	12 in the Kross scale
LOCK TYPE	Key
WEIGHT	2.867 kg
THICKNESS	10 mm
LENGTH	120 cm
ADDITIONAL INFORMATION	2 keys included

T4CZP000233



KZL 600

A chain with 10 mm links with square cross-section in a fabric protective sleeve. The chain is made of specially reinforced and hardened steel. The ergonomic lock is covered with a soft plastic material that ensures frame protection against scratches and impacts.

MATERIAL	The chain is made of reinforced, hardened steel.
PROTECTION LEVEL	9 in the Kross scale
LOCK TYPE	Key
WEIGHT	2.251 kg
THICKNESS	10 mm
LENGTH	100 cm
ADDITIONAL INFORMATION	2 keys included
	Automatic cylinder
	Dust cover

T4CZP000234



KZL 550

A chain with 8 mm links with square cross-section in a fabric protective sleeve. The chain is made of specially reinforced and hardened steel. The ergonomic lock is covered with a soft plastic material that ensures frame protection against scratches and impacts.

MATERIAL	The chain is made of reinforced, hardened steel.
PROTECTION LEVEL	8 in the Kross scale
LOCK TYPE	Key
WEIGHT	1.611 kg
THICKNESS	8 mm
LENGTH	100 cm
ADDITIONAL INFORMATION	2 keys included
	Automatic cylinder
	Dust cover

T4CZP000235



KZL 500

A chain with 5 mm links with oval cross-section with a new, functional and extremely flexible material of the protective sleeve. The chain is made of specially reinforced and hardened steel. The ergonomic lock features a soft cover that absorbs any impacts and is protected against drilling.

HEAD MATERIAL	Reinforced steel with a plastic outer shell.
PROTECTION LEVEL	6 in the Kross scale
LOCK TYPE	Key
WEIGHT	0.486 kg
DIAMETER	5 mm
LENGTH	85 cm
ADDITIONAL INFORMATION	2 keys included
	Automatic cylinder
	Dust cover

T4CZP000236



KZK 500S

A reinforced, keyed, highly flexible bicycle lock. Steel braid of 5.5 mm in diameter, protected by steel overlapping, 25 mm thick rings. The plastic cover protects the bicycle frame against scratches.

HEAD MATERIAL	Zinc alloy with a plastic outer shell
PROTECTION LEVEL	6 in the Kross scale
LOCK TYPE	Key
WEIGHT	0.821 kg
THICKNESS	25 mm
LENGTH	100 cm
ADDITIONAL INFORMATION	2 keys included
	Automatic cylinder
	Dust cover

T4CZP000240



KZK 400S

Robust spiral lock with a soft coating that protects the frame from scratches. Features an automatic cylinder and a symmetrical key. Steel rings of 22 mm in diameter protect the inner steel braid for increased safety.

HEAD MATERIAL	Zinc alloy with a plastic outer shell
PROTECTION LEVEL	7 in the Kross scale
LOCK TYPE	Key
WEIGHT	1.04 kg
Ring diameter	22 mm
LENGTH	100 cm
ADDITIONAL INFORMATION	2 keys included
	Automatic cylinder
	Dust cover

T4CZP000241



KZK 300L

Robust spiral lock with a soft coating that protects the frame from scratches. Features an automatic cylinder and a symmetrical key.

HEAD MATERIAL	Zinc alloy with a plastic outer shell
PROTECTION LEVEL	5 in the Kross scale
LOCK TYPE	Flat key
LENGTH	180 cm
DIAMETER	15 mm
ADDITIONAL INFORMATION	2 keys included
	Automatic cylinder
	Dust cover

T4CZP000242



KZK 300M

Robust spiral lock with a soft coating that protects the frame from scratches. Features an automatic cylinder and a symmetrical key.

HEAD MATERIAL	Zinc alloy with a plastic outer shell
PROTECTION LEVEL	5 in the Kross scale
LOCK TYPE	Flat key
LENGTH	150 cm
DIAMETER	15 mm
ADDITIONAL INFORMATION	
	2 keys included
	Automatic cylinder
	Dust cover

T4CZP000243



KZK 300S

Robust spiral lock with a soft coating that protects the frame from scratches. Features an automatic cylinder and a symmetrical key.

HEAD MATERIAL	Zinc alloy with a plastic outer shell
PROTECTION LEVEL	5 in the Kross scale
LOCK TYPE	Flat key
LENGTH	120 cm
DIAMETER	15 mm
ADDITIONAL INFORMATION	
	2 keys included
	Automatic cylinder
	Dust cover

T4CZP000244



KZK 200L

Robust spiral lock with a soft coating that protects the frame from scratches. Features an automatic cylinder and a symmetrical key.

HEAD MATERIAL	Zinc alloy with a plastic outer shell
PROTECTION LEVEL	4 in the Kross scale
LOCK TYPE	Flat key
LENGTH	180 cm
DIAMETER	12 mm
ADDITIONAL INFORMATION	
	2 keys included
	Automatic cylinder
	Dust cover

T4CZP000246



KZK 200M

Robust spiral lock with a soft coating that protects the frame from scratches. Features an automatic cylinder and a symmetrical key.

HEAD MATERIAL	Zinc alloy with a plastic outer shell
PROTECTION LEVEL	4 in the Kross scale
LOCK TYPE	Flat key
LENGTH	150 cm
DIAMETER	12 mm
ADDITIONAL INFORMATION	
	2 keys included
	Automatic cylinder
	Dust cover

T4CZP000247



KZK 200S

Robust spiral lock with a soft coating that protects the frame from scratches. Features an automatic cylinder and a symmetrical key.

HEAD MATERIAL	Zinc alloy with a plastic outer shell
PROTECTION LEVEL	4 in the Kross scale
LOCK TYPE	Flat key
LENGTH	120 cm
DIAMETER	12 mm
ADDITIONAL INFORMATION	
	2 keys included
	Automatic cylinder
	Dust cover

T4CZP000248



KZK 110L

Robust spiral lock with a soft coating that protects the frame from scratches. Features an automatic cylinder and a symmetrical key.

HEAD MATERIAL	Zinc alloy with a plastic outer shell
PROTECTION LEVEL	3 in the Kross scale
LOCK TYPE	Flat key
LENGTH	180 cm
DIAMETER	10 mm
ADDITIONAL INFORMATION	
	2 keys included
	Automatic cylinder
	Dust cover

T4CZP000250



KZK 110M

Robust spiral lock with a soft coating that protects the frame from scratches. Features an automatic cylinder and a symmetrical key.

HEAD MATERIAL	Zinc alloy with a plastic outer shell
PROTECTION LEVEL	3 in the Kross scale
LOCK TYPE	Flat key
LENGTH	150 cm
DIAMETER	10 mm
ADDITIONAL INFORMATION	
	2 keys included
	Automatic cylinder
	Dust cover

T4CZP000251



KZK 110S

Robust spiral lock with a soft coating that protects the frame from scratches. Features an automatic cylinder and a symmetrical key.

HEAD MATERIAL	Zinc alloy with a plastic outer shell
PROTECTION LEVEL	3 in the Kross scale
LOCK TYPE	Flat key
LENGTH	120 cm
DIAMETER	10 mm
ADDITIONAL INFORMATION	
	2 keys included
	Automatic cylinder
	Dust cover

T4CZP000252



KZK 100S

Robust spiral lock with a soft coating that protects the frame from scratches. Features an automatic cylinder and a symmetrical key.

HEAD MATERIAL	Zinc alloy with a plastic outer shell
PROTECTION LEVEL	4 in the Kross scale
LOCK TYPE	Flat key
LENGTH	65 cm
DIAMETER	12 mm
ADDITIONAL INFORMATION	
	2 keys included
	Automatic cylinder
	Dust cover

T4CZP000254



KZK 80S

A spiral keyed lock of 80 cm in length and 10 mm in diameter. Plastic coating protects the frame from scratches. Features an automatic cylinder and a dust cover. Two reversible keys included.

HEAD MATERIAL	Zinc alloy with a plastic outer shell
PROTECTION LEVEL	3 in the Kross scale
LOCK TYPE	Flat key
LENGTH	80 cm
DIAMETER	10 mm
ADDITIONAL INFORMATION	2 keys included

T4CZP000255



KZK 60S

A keyed lock of 60 cm in length and 10 mm in diameter. Plastic coating protects the frame from scratches. Features an automatic cylinder and a dust cover. Two reversible keys included.

HEAD MATERIAL	Zinc alloy with a plastic outer shell
PROTECTION LEVEL	3 in the Kross scale
LOCK TYPE	Flat key
LENGTH	60 cm
DIAMETER	10 mm
ADDITIONAL INFORMATION	2 keys included

T4CZP000256



KZS 300S

Robust spiral lock with a soft coating that protects the frame from scratches. Code lock protection makes it easy for a few people to use the lock and does not require having a key. Made of a highly resistant material, it secures your gear even better.

HEAD MATERIAL	Zinc alloy with a plastic outer shell
PROTECTION LEVEL	5 in the Kross scale
LOCK TYPE	4-digit resettable code
LENGTH	120 cm
DIAMETER	15 mm

T4CZP000245



KZS 200S

Robust spiral lock with a soft coating that protects the frame from scratches. Code lock protection makes it easy for a few people to use the lock and does not require having a key. Made of a highly resistant material, it secures your gear even better.

HEAD MATERIAL	Zinc alloy with a plastic outer shell
PROTECTION LEVEL	4 in the Kross scale
LOCK TYPE	4-digit resettable code
LENGTH	120 cm
DIAMETER	12 mm

T4CZP000249



KZS 110S

Robust spiral lock with a soft coating that protects the frame from scratches. Code lock protection makes it easy for a few people to use the lock and does not require having a key. Made of a highly resistant material, it secures your gear even better.

HEAD MATERIAL	Zinc alloy with a plastic outer shell
PROTECTION LEVEL	3 in the Kross scale
LOCK TYPE	4-digit resettable code
LENGTH	120 cm
DIAMETER	10 mm

T4CZP000253



ACCESSORIES

BELLS





I LOVE MY BIKE

Bicycle bell made of aluminum; easy to fit. Its loud sound will let everyone know that you are there.

MATERIAL	Aluminum
INSTALLATION	Plastic O-ring
WEIGHT	34 g

T4CDZ000080



BEEP

Bicycle bell made of aluminum; easy to fit. Its loud sound will let everyone know that you are there.

MATERIAL	Aluminum
INSTALLATION	Plastic O-ring
WEIGHT	18 g

T4CDZ000081



BUZZER

Bicycle bell made of aluminum; easy to fit. Its loud sound will let everyone know that you are there.

MATERIAL	Aluminum
INSTALLATION	Plastic O-ring
WEIGHT	18 g

T4CDZ000082



BOW

Everyone will love these colorful streamers! You can use them to decorate any bike, whether it's new or has been used for years, to make it look special.

MATERIAL	Polyester
INSTALLATION	For handlebar grips

LGCIN0000010 mix



KID SUPPORT 300

A set of universal support wheels that fits all 10-20" wheel bikes. Helpful for the first bike rides, when your child is learning to keep his/her balance.

MATERIAL	Steel; plastic (wheels)
MOUNTED	On the wheel axle with 2 stainless screws
SIZE	10-20"

T4CKB0000013



RAINBOW

Aesthetic multi-colored handlebar pinwheel. Universal, attaches to handlebars with a diameter of 19-22 mm. Easy installation without the use of tools.

MATERIAL	Plastic
INSTALLATION	On the handlebars

T4CADZIE001N mix

ACCESSORIES

CHILD SEATS & TRAILERS





GUPPY RS

This child seat was made with the use of the finest materials and ensures comfort and safety during small and big trips with your little ones. The seat can be fitted to frames with round or oval seatpost cross-sections of 28 to 40 mm in diameter. Compatible with bikes with bottom or top gear assembly. The five point safety belts with comfortable padding guarantee a stable and safe position of your child. Adjustable footrests will help to match the position as your child grows. The lining is made of an easy-to-wash fabric that also dries quickly in case of any emergencies.

ATTACHMENT POINT	Frame
CHILD WEIGHT	From 9 to 22 kg
CERTIFICATION	EN 14344

T4CFO00003BE	beige
T4CFO00003GY	grey



CHILD SEAT WALLAROO CMS

This child seat was made with the use of the finest materials and ensures comfort and safety during small and big trips with your little ones. A rack-mounted child seat with QST quick release mechanism. Compatible with rear racks with platforms no wider than 175 mm. The three point safety belts with comfortable padding guarantee a stable and safe position of your child. Adjustable 4-step footrests will help to match the position as your child grows. The lining is made of a quick drying and easy-to-wash fabric.

ATTACHMENT POINT	Rack
CHILD WEIGHT	From 9 to 22 kg
CERTIFICATION	EN 14344
ADDITIONAL INFORMATION	The rack platform must be no wider than 175 mm

T4CFO00004	
-------------------	--



WALAROO

This child seat was made with the use of the finest materials and ensures comfort and safety during small and big trips with your little ones. The seat can be fitted to frames with round or oval seatpost cross-sections of 28 to 40 mm in diameter. Compatible with bikes with bottom or top gear assembly. The three-point safety belts with comfortable padding guarantee a stable position without restricting your child's movement. Adjustable footrests with a six-point scale will help you to match the position as your child grows. The lining is made of an easy-to-wash fabric that also dries quickly in case of any emergencies.

ATTACHMENT POINT	Frame
CHILD WEIGHT	From 9 to 22 kg
CERTIFICATION	EN 14344

T4CFO000001BK	black
T4CFO000001BL	blue
T4CFO000001GY	grey



NEW

SANBAS

A child seat made from the best materials which will ensure comfort and safety during short and long trips with children. The seat is attached to the frame with a round or oval seat tube with a diameter of 30 to 36 mm. It is compatible with bicycles with lower and upper derailleur. The three-point safety harness with comfort padding guarantees a stable position of the child without restricting movement. Four-step footrests allow you to adjust the position as your child grows. The lining is made from a washable, quick-drying material.

MOUNTING	To the frame
CHILD WEIGHT	9-22 kg
CERTIFICATE	EN 14344

T4CF000008DGY grey



NEW

FRAACH

A child seat made from the best materials which will ensure comfort and safety during short and long trips with children. The seat is attached to the frame with a round or oval seat tube with a diameter of 30 to 36mm. It is compatible with bicycles with lower and upper derailleur. The three-point safety harness with comfort padding guarantees a stable position of the child without restricting movement. Four-step footrests allow you to adjust the position as your child grows. The lining is made from a washable, quick-drying material.

MOUNTING	To the frame
CHILD WEIGHT	9-22 kg
CERTIFICATE	EN 14344

T4CF0000010DGY grey



NEW

FRAACH

A child seat made from the best materials which will ensure comfort and safety during short and longer trips with children. The seat is attached to the carrier using a quick-release mount. It is compatible with rear carrier with a platform width not exceeding 146 mm. The three-point safety harness with comfort padding guarantees a stable and safe position of the child. Adjustable four-step footrests allow you to adjust the position as your child grows. The lining is made from a washable, quick-drying material.

MOUNTING	To the carrier
CHILD WEIGHT	9-22 kg
CERTIFICATE	EN 14344
ADDITIONAL INFORMATION	The width of the carrier platform must not exceed 146 mm

T4CF000009DGY grey



NEW

KIT FRAME

KIT FRME is a fastening element that allows you to install the seat on an additional bike. The quick-attach system ensures convenient installation on the bicycle frame.

ADDITIONAL INFORMATION

Designed for ELIBAS, SANBAS, and FRAACH child seats, for bicycles with frames with a diameter of the seat tube of 30 to 36 mm.

T4CIN000024



NEW

SPRING SET

SPRING SET is a fastening element that allows you to install the seat in case the saddle is set too low or the bike is equipped with 29" wheels.

ADDITIONAL INFORMATION

Compatible with ELIBAS, SANBAS, and FRAACH child seats

T4CIN000025





JOY

The JOY child trailer features a dual-adjust suspension and an integrated hand brake. Both systems ensure great comfort and safety during use. The trailer's interior offers a generous space around the arm and hip area, and can accommodate two children, who can discover the world together with their parents. A new, magnetic 5-point safety belt system features an additional innovation that makes everyday life easier. Thanks to the materials used, the trailer is lightweight and easy to assemble. Reflective elements improve trailer visibility.

ADDITIONAL INFORMATION

The trailer is adapted to transport up to two children. Recommended for children over 12 months of age - the child must sit up independently. The permissible total weight should not exceed 45 kg (trailer + children + luggage) and the nominal load should not exceed 30 kg (children + luggage).
20-inch aluminum detachable wheels
Frame made of a lightweight aluminum alloy
5-point safety belts
Large luggage compartment
Parking brake
Dual-adjust suspension
Easy assembly and disassembly
Wind and insect protection
Features a universal coupling and safety flag
Conforms to EN15918 standard: 2011 + A2: 2017

T4CPP000001



FREEDOM

FREEDOM bicycle trailer is designed to carry children. Features an integrated brake. Ensures great comfort and safety during use. The trailer's interior offers a generous space around the arm and hip area, and can accommodate two children, who can discover the world together with their parents. A new, magnetic 3-point safety belt system features an additional innovation that makes everyday life easier. Thanks to the materials used, the trailer is lightweight and easy to assemble. Reflective elements improve trailer visibility.

ADDITIONAL INFORMATION

The trailer is adapted to transport up to two children. Recommended for children over 12 months of age - the child must sit up independently. The permissible total weight should not exceed 45 kg (trailer + children + luggage) and the nominal load should not exceed 30 kg (children + luggage).
20-inch aluminum detachable wheels
Frame made of a lightweight aluminum alloy
3-point safety belts
Large luggage compartment
Parking brake
Easy assembly and disassembly
Wind and insect protection
Features a universal coupling and safety flag
Conforms to EN15918 standard: 2011 + A2: 2017

T4CPP000002



HITCH

Hitch for Joy and Freedom bicycle trailers. Easy to install, with a complete coupling arm and hitch joint. Easy to install with no tools needed. High-quality steel material ensures durability and useful application.

MATERIAL	Steel
COMPATIBILITY	Kross Joy / Freedom trailers

T4CPPACC005



FREEDOM JOGGER KIT

Transform your Freedom trailer into a jogging stroller! Easy assembly: simply snap the kit into the trailer.

MATERIAL	Aluminum
WHEEL DIAMETER	16"
COMPATIBILITY	Kross Freedom trailer

T4CPPACC002



JOY JOGGER KIT

Transform your Joy trailer into a jogging stroller! Easy assembly: simply snap the kit into the trailer. V-brake and brake rope included.

MATERIAL	Aluminum
WHEEL DIAMETER	16"
COMPATIBILITY	Kross Joy trailer

T4CPPACC001



AKCESORIA

CAR BIKE RACKS





MOVE 4.0

Move 4.0 is a platform towbar bike rack allowing you to transport up to four conventional road and mountain bicycles. Made of aluminium, it is very light so you can easily install it on your own. When folded, it will fit into most car boots. It can be tilted with the bikes, so you can easily access the full boot without removing them. Any bicycles carried and the rack are secured against theft. Thanks to the double grip system for the wheels and the frame, transporting bicycles on the platform guarantees their stable and secure attachment. Transporting bicycles on the Move 4.0 platform also has other advantages: there is no problem with entering underground car parks or shopping centres and the driving comfort is improved (it is silent - unlike when you transport bicycles on the roof). Independent tests of towbar racks confirm that transporting bicycles on them translates into lower fuel consumption. Move 4.0 complies with current Polish and EU traffic regulations.

RACK TYPE	Platform
MAX. NUMBER OF BICYCLES	4
MAX. BICYCLE WEIGHT	15 kg
MAX. LOAD	60 kg
MAX. TYRE WIDTH	65 mm
MAX. FRAME DIAMETER	30-80 mm
POWER CONNECTOR	13-pin
NUMBER PLATE HOLDER	Yes
MOUNTING LOCATION	Towbar
BICYCLE MOUNTING	Wheels and frame
WHEEL MOUNTING IN ADJUSTABLE BRACKETS	Yes
CAN BE TILTED WITH BICYCLES MOUNTED	Yes
FITS CARS WITH A SPARE WHEEL ON THE BACK DOOR	Yes
ANTI-THEFT PROTECTION	Key lock
TOWBAR RACK LOCK	Key lock
DETACHABLE FRAME HOLDERS	Yes
DIMENSIONS WHEN UNFOLDED	826 x 1115 x 943 mm
TOTAL WEIGHT	25 kg
MAX. VEHICLE SPEED	120 km/h
CERTIFICATE	ISO DIS 15263

T4CBAS00003

black



MOVE 3.0

Move 3.0 is a compact platform towbar bike rack that allows you to transport as many as three conventional bikes, both road and mountain. Made of aluminium, it is so light you can easily install it on your own. It can be tilted with the bikes, so you can easily access the full boot without removing them. Any bicycles carried and the rack are secured against theft. Thanks to the double grip system for the wheels and the frame, transporting bicycles on the platform guarantees their stable and secure attachment. Transporting bicycles on Move 3.0 platforms also has other advantages: there is no problem with entering underground car parks or shopping centres, and driving comfort is improved (it is silent - unlike when you transport bicycles on the roof). Independent tests of towbar racks confirm that transporting bicycles on them translates into lower fuel consumption. Move 3.0 complies with current Polish and EU traffic regulations.

RACK TYPE	Platform
MAX. NUMBER OF BICYCLES	3
MAX. BICYCLE WEIGHT	15 kg
MAX. LOAD	45 kg
MAX. TYRE WIDTH	65 mm
MAX. FRAME DIAMETER	30-80 mm
POWER CONNECTOR	13-pin
NUMBER PLATE HOLDER	Yes
MOUNTING LOCATION	Towbar
BICYCLE MOUNTING	Wheels and frame
WHEEL MOUNTING IN ADJUSTABLE BRACKETS	Yes
CAN BE TILTED WITH BICYCLES MOUNTED	Yes
FITS CARS WITH A SPARE WHEEL ON THE BACK DOOR	Yes
ANTI-THEFT PROTECTION	Key lock
TOWBAR RACK LOCK	Key lock
DETACHABLE FRAME HOLDERS	Yes
DIMENSIONS WHEN UNFOLDED	826 x 1115 x 763 mm
TOTAL WEIGHT	21.8 kg
MAX. VEHICLE SPEED	120 km/h
CERTIFICATE	ISO DIS 15263

T4CBAS00002

black



MOVE 2.0

Move 2.0 is a compact platform towbar bike rack, allowing you to transport up to 2 classic bikes, both road and mountain. Made of aluminium, it is so light you can easily install it on your own. When folded, it will fit into most car boots. It can be tilted with the bikes, so you can easily access the full boot without first removing them. Any bicycles carried and the rack are secured against theft. Thanks to the double grip system for the wheels and the frame, transporting bicycles on the platform guarantees their stable and secure attachment. Transporting bicycles on platforms also has other advantages: there is no problem with entering underground car parks or shopping centres, driving comfort is improved (it is silent - unlike when you transport bicycles on the roof) and, as confirmed by independent tests carried out on such products, this also translates into lower fuel consumption. Move 2.0 complies with current Polish and EU traffic regulations.

RACK TYPE	Platform
MAX. NUMBER OF BICYCLES	2
MAX. BICYCLE WEIGHT	15 kg
MAX. LOAD	30 kg
MAX. TYRE WIDTH	65 mm
MAX. FRAME DIAMETER	30-80 mm
POWER CONNECTOR	13-pin
NUMBER PLATE HOLDER	Yes
MOUNTING LOCATION	Towbar
BICYCLE MOUNTING	Wheels and frame
WHEEL MOUNTING IN ADJUSTABLE BRACKETS	Yes
CAN BE TILTED WITH BICYCLES MOUNTED	Yes
FITS CARS WITH A SPARE WHEEL ON THE BACK DOOR	Yes
ANTI-THEFT PROTECTION	Key lock
TOWBAR RACK LOCK	Key lock
DETACHABLE FRAME HOLDERS	Yes
DIMENSIONS WHEN UNFOLDED	826 x 1115 x 475 mm
TOTAL WEIGHT	18 kg
MAX. VEHICLE SPEED	120 km/h
CERTIFICATE	ISO DIS 15263

T4CBAS00001

black



NOWOŚĆ

E-MOVE 2.0

e-Move 2.0 is a platform towbar bike rack for transporting two electric bicycles. Even though it is made of steel, it is so light that you can easily install it on your own. It includes a set of lights powered by a 13-pin power connector. It can be tilted with the bikes, so you can easily access the boot without first removing them. With anti-theft locks for bicycles and the platform itself, e-Move 2.0 complies with the applicable Polish and EU road traffic regulations. Thanks to the double grip system for the wheels and the frame, bicycles are transported in a safe and stable manner. Thanks to the platform, there is no problem with entering underground car parks or shopping centres, and air resistance is also reduced, which means greater comfort of driving (it is silent - unlike when you transport bicycles on the roof). As confirmed by independent tests of such products, this also translates into lower fuel consumption.

RACK TYPE	Platform
MAX. NUMBER OF BICYCLES	2
MAX. BICYCLE WEIGHT	30 kg
MAX. LOAD	60 kg
MAX. TYRE WIDTH	80 mm
MAX. FRAME DIAMETER	30-80 mm
POWER CONNECTOR	13-pin
NUMBER PLATE HOLDER	Yes
MOUNTING LOCATION	Towbar
BICYCLE MOUNTING	Wheels and frame
WHEEL MOUNTING IN ADJUSTABLE BRACKETS	Yes
CAN BE TILTED WITH BICYCLES MOUNTED	Yes
FITS CARS WITH A SPARE WHEEL ON THE BACK DOOR	Yes
ANTI-THEFT PROTECTION	Key lock
TOWBAR RACK LOCK	Key lock
DETACHABLE FRAME HOLDERS	Yes
DIMENSIONS WHEN UNFOLDED	786 x 1320 x 617 mm
TOTAL WEIGHT	20 kg
MAX. VEHICLE SPEED	120 km/h
CERTIFICATE	ISO DIS 15263

T4CBAS00004

black



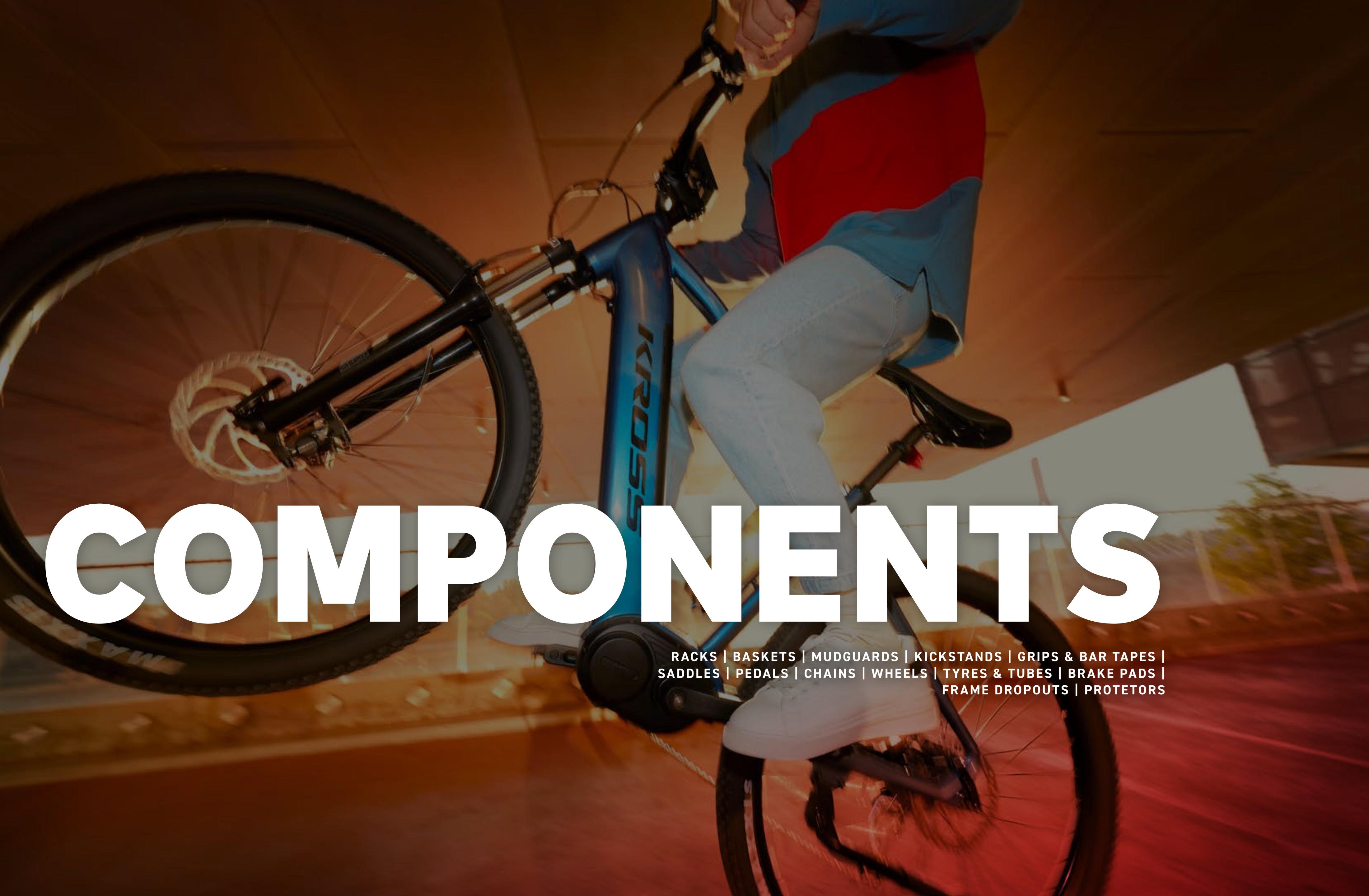

COMPONENTS

RACKS | BASKETS | MUDGUARDS | KICKSTANDS | GRIPS & BAR TAPES |
SADDLES | PEDALS | CHAINS | WHEELS | TYRES & TUBES | BRAKE PADS |
FRAME DROPOUTS | PROTETORS

COMPONENTS

RACKS





TRAVELRACK CM

A professional adjustable aluminum bike rack equipped with the CARRY MORE quick attach and release system. The lowered point of pannier attachment increases ride safety and comfort due to the lower center of gravity. Convenient adjustment system helps to fit the rack to frames of various shapes and various wheel sizes (24-28"). Its construction allows for use with frames featuring disc brakes. Rear plate shape makes it suitable for backlights with 50-80 mm bolt spacing. Max load capacity 25 kg.

WHEEL SIZE	24-28"
MATERIAL	Aluminum 6061-T6
LOAD CAPACITY	25 kg
ATTACHMENT LOCATION	Rear
WEIGHT	1039 g
ADDITIONAL INFO	Carry More quick mounting system Suitable for attaching panniers

T4CBA260090



TRAVELRACK

A professional adjustable bike rack. Its lowered pannier attachment point lowers the center of gravity, increasing safety and comfort during cycling. Convenient adjustment system helps to fit the rack to frames of various shapes and various wheel sizes. Its construction allows for use with frames featuring disc brakes. Rear plate shape makes it suitable for backlights with 50-80 mm bolt spacing.

WHEEL SIZE	24-28"
MATERIAL	Aluminum 6061-T6
LOAD CAPACITY	25 kg
ATTACHMENT LOCATION	Rear
WEIGHT	858 g
ADDITIONAL INFO	Compatible with models equipped with disc brakes Suitable for attaching panniers

T4CBA260088



EVATRANS CM S

EVATRANS is a bespoke rack mounted to the upper tube of the rear triangle. Equipped with the CARRY MORE quick attach and release system for compatible bags and baskets. The lowered point of pannier attachment increases safety and comfort due to the lower center of gravity when riding with a load. Compatible with TRANS and EVADO bikes from model years 2022 - 2023 in the 17" size. Rear plate shape makes it suitable for backlights with 50-80 mm bolt spacing. Max load capacity 25 kg.

WHEEL SIZE	28"
FRAME SIZE	17"
MATERIAL	Aluminum 6061-T6
LOAD CAPACITY	25 kg
ATTACHMENT LOCATION	Rear
WEIGHT	725 g
ADDITIONAL INFO	Carry More quick mounting system Compatible with KROSS bicycles: TRANS and EVADO from the year 2023; TRANS, SENTIO, EVADO, ESKER, HEXAGON, LEA from the year 2024 Suitable for attaching panniers

T4CBA280093



EVATRANS CM L

EVATRANS is a bespoke rack mounted to the upper tube of the rear triangle. Equipped with the CARRY MORE quick attach and release system for compatible bags and baskets. The lowered point of pannier attachment increases safety and comfort due to the lower center of gravity when riding with a load. Compatible with Trans and Evado bikes from model years 2022 - 2023 in the 19-23" sizes. Rear plate shape makes it suitable for backlights with 50-80 mm bolt spacing. Max load capacity 25 kg.

WHEEL SIZE	28"
FRAME SIZE	19-23"
MATERIAL	Aluminum 6061-T6
LOAD CAPACITY	25 kg
ATTACHMENT LOCATION	Rear
WEIGHT	745 g
ADDITIONAL INFO	Carry More quick mounting system Compatible with KROSS bicycles: TRANS and EVADO from the year 2023; TRANS, SENTIO, EVADO, ESKER, HEXAGON, LEA from the year 2024. Suitable for attaching panniers

T4CBA280094



WEEKENDRACK 200

A lightweight frame-mounted rack. Convenient adjustment system helps to fit the rack to frames of various shapes and various wheel sizes. Rear plate shape makes it suitable for backlights with 50-80 mm bolt spacing.

WHEEL SIZE	24-28"
MATERIAL	Aluminum 6061-T6
LOAD CAPACITY	18 kg
ATTACHMENT LOCATION	Rear
WEIGHT	694 g

T4CBA260087BK



LIBERTY CM

This bike rack is mounted to the seatpost and is equipped with the CARRY MORE quick attach and release system. For frames that do not have traditional rack mounts or their shape does not allow to have such a rack attached. The quick release makes removing the rack easy. CAUTION: Do not attach to seatposts made of carbon fiber. Max load capacity 10 kg.

WHEEL SIZE	24-29"
MATERIAL	Aluminum 6061-T6
LOAD CAPACITY	10 kg
ATTACHMENT LOCATION	Rear
WEIGHT	877 g
ADDITIONAL INFO	Carry More quick mounting system

T4CBA000086



ADVENTURE FOR ESKER

A professional expedition rack designed for bikes with 28" wheels. Perfect for carrying panniers. The lowered pannier attachment point lowers the center of gravity, increasing safety and comfort during cycling. Convenient adjustment system helps to fit the rack to frames of various shapes. Rear plate shape makes it suitable for backlights with 50-80 mm bolt spacing.

WHEEL SIZE	28"
MATERIAL	Aluminum 6061-T6
LOAD CAPACITY	25 kg
ATTACHMENT LOCATION	Rear
WEIGHT	810 g
ADDITIONAL INFO	Compatible with ESKER bikes Suitable for attaching panniers

T4CBA280092



EVATRANS LIGHT S

EVATRANS Light is a bespoke rack mounted to the upper tube of the rear triangle. The lowered point of pannier attachment increases safety and comfort due to the lower center of gravity when riding with a load. Compatible with TRANS and EVADO bikes from model years 2022 - 2023 in the 17" size. Rear plate shape makes it suitable for backlights with 50-80 mm bolt spacing. Max load capacity 25 kg.

WHEEL SIZE	28"
FRAME SIZE	17"
MATERIAL	Aluminum 6061-T6
LOAD CAPACITY	25 kg
ATTACHMENT LOCATION	Rear
WEIGHT	725 g
ADDITIONAL INFO	Compatible with KROSS bicycles: TRANS and EVADO from the year 2023; TRANS, SENTIO, EVADO, ESKER, HEXAGON, LEA from the year 2024. Suitable for attaching panniers

T4CBA280095



EVATRANS LIGHT L

EVATRANS Light is a bespoke rack mounted to the upper tube of the rear triangle. The lowered point of pannier attachment increases safety and comfort due to the lower center of gravity when riding with a load. Compatible with Trans and Evado bikes from model years 2022 - 2023 in the 19-23" sizes. Rear plate shape makes it suitable for backlights with 50-80 mm bolt spacing. Max load capacity 25 kg.

WHEEL SIZE	28"
FRAME SIZE	19-23"
MATERIAL	Aluminum 6061-T6
LOAD CAPACITY	25 kg
ATTACHMENT LOCATION	Rear
WEIGHT	745 g
ADDITIONAL INFO	Compatible with KROSS bicycles: TRANS and EVADO from the year 2023; TRANS, SENTIO, EVADO, ESKER, HEXAGON, LEA from the year 2024. Suitable for attaching panniers

T4CBA280096

KROSS BICYCLE COMPATIBILITY TABLE WITH EVATRANS SERIES RACKS



LIBERTYRACK 300

A seatpost-mounted rack. For frames that do not have traditional rack mounts or their shape does not allow to have such a rack attached. The quick release makes removing the rack easy. CAUTION: Do not attach to seatposts made of carbon fiber. Max load capacity 10 kg.

WHEEL SIZE	24-29"
MATERIAL	Aluminum 6061-T6
LOAD CAPACITY	10 kg
ATTACHMENT LOCATION	Seatpost
WEIGHT	705 g

T4CBA000084

T4CBA280095 & T4CBA280093

RACK SKU No.	Bicycle model name	Production season	
		S23	S24
	ESKER 1 L		v
	ESKER 1 M		v
	ESKER 1 S		v
	ESKER 2 L		v
	ESKER 2 M		v
	ESKER 2 S		v
	ESKER 5 L		v
	ESKER 5 M		v
	ESKER 5 S		v
	ESKER 6 L		v
	ESKER 6 M		v
	ESKER 6 S		v
	EVADO 2 M		v
	EVADO 2 S		v
	EVADO 3 M	v	v
	EVADO 4 M	v	v
	EVADO 5 M	v	v
	EVADO 7 M	v	v
	EVADO HYBRID 2 M		v
	EVADO HYBRID 3 M		v
	HEXAGON 2 EQ L		v
	HEXAGON 2 EQ M		v
	HEXAGON 2 L		v
	HEXAGON 2 M		v
	HEXAGON 3 L		v
	HEXAGON 3 M		v
	HEXAGON 4 EQ L		v
	HEXAGON 4 EQ M		v
	HEXAGON 4 L		v
	HEXAGON 4 M		v
	HEXAGON 5 L		v
	HEXAGON 5 M		v
	LEA 2 EQ L		v
	LEA 2 EQ M		v
	LEA 2 L		v
	LEA 2 M		v
	LEA 3 L		v
	LEA 3 M		v
	LEA 4 EQ L		v
	LEA 4 EQ M		v
	LEA 4 L		v
	LEA 4 M		v
	LEA 5 L		v
	LEA 5 M		v
	SENTIO 1 S		v
	SENTIO 2 S		v
	SENTIO 3 S		v
	SENTIO 4 S		v
	TRANS 1 M	v	v
	TRANS 1 S	v	v
	TRANS 2 M	v	
	TRANS 2 S	v	
	TRANS 3 M	v	v
	TRANS 4 M		v
	TRANS 5 M		v
	TRANS 7 M		v
	TRANS HYBRID LS 1 S		v

T4CBA280096 & T4CBA280094

RACK SKU No.	Bicycle model name	Production season	
		S23	S24
	ESKER 1 XL		v
	ESKER 2 XL		v
	ESKER 5 XL		v
	ESKER 6 XL		v
	EVADO 2 L		v
	EVADO 2 M		v
	EVADO 3 L	v	v
	EVADO 3 M	v	v
	EVADO 3 XL	v	v
	EVADO 4 L	v	v
	EVADO 4 M	v	v
	EVADO 4 XL	v	v
	EVADO 5 L	v	v
	EVADO 5 M	v	v
	EVADO 5 XL	v	v
	EVADO 7 L	v	v
	EVADO 7 M	v	v
	EVADO 7 XL	v	v
	EVADO HYBRID 2 L		v
	EVADO HYBRID 2 M		v
	EVADO HYBRID 3 L		v
	EVADO HYBRID 3 M		v
	HEXAGON 2 EQ XL		v
	HEXAGON 2 EQ XXL		v
	HEXAGON 2 XL		v
	HEXAGON 2 XXL		v
	HEXAGON 3 XL		v
	HEXAGON 3 XXL		v
	HEXAGON 4 EQ XL		v
	HEXAGON 4 EQ XXL		v
	HEXAGON 4 XL		v
	HEXAGON 4 XXL		v
	HEXAGON 5 XL		v
	HEXAGON 5 XXL		v
	SENTIO 1 M		v
	SENTIO 2 M		v
	SENTIO 3 M		v
	SENTIO 4 M		v
	TRANS 1 L	v	v
	TRANS 1 M	v	v
	TRANS 2 L	v	
	TRANS 2 M	v	
	TRANS 3 L	v	v
	TRANS 3 M	v	v
	TRANS 3 XL	v	v
	TRANS 4 L		v
	TRANS 4 M		v
	TRANS 4 XL		v
	TRANS 5 L		v
	TRANS 5 M		v
	TRANS 5 XL		v
	TRANS HYBRID LS 1 M		v

T4CBA280097 & T4CBA280098

RACK SKU No.	Bicycle model name	Production season	
		S23	S24
	HEXAGON 2 EQ M		v
	HEXAGON 2 EQ S		v
	HEXAGON 2 M		v
	HEXAGON 2 S		v
	HEXAGON 3 M		v
	HEXAGON 3 S		v
	HEXAGON 4 EQ M		v
	HEXAGON 4 EQ S		v
	HEXAGON 4 M		v
	HEXAGON 4 S		v
	HEXAGON 5 M		v
	HEXAGON 5 S		v
	LEA 2 EQ S		v
	LEA 2 S		v
	LEA 2 XS		v
	LEA 3 S		v
	LEA 3 XS		v
	LEA 4 EQ S		v
	LEA 4 S		v
	LEA 4 XS		v
	LEA 5 S		v
	LEA 5 XS		v

COMPONENTS

BASKETS





POPPY

If you fancy cycling with your pooch, then this basket is for you. Additional protection guarantees greater comfort for your pet while traveling.

MATERIAL	Polyrattan + wire mesh
DIMENSIONS	500 x 350 x 210 / 270 mm
WEIGHT	2200 + 519 g
RACK-MOUNTABLE	Yes

LGCKZT000037 brown



FREESIA

A rattan front basket made of PVC makes a perfect companion for all weather conditions. Find a matching lining to travel comfortably and in style. The quick mounting system is compatible with all Le Grand baskets. Features the Quick Branch system for quick handlebar mounting.

MATERIAL	Polyrattan
DIMENSIONS	350 x 250 x 250 mm
WEIGHT	1683 g
HANDLEBAR-MOUNTABLE	Yes

LGCKZT000034 brown



HYACINTH

Rear basket made of PVC, perfect for everyday shopping as it will hold more items. Use bungee cords to secure your luggage.

MATERIAL	Polyrattan
DIMENSIONS	410 x 310 x 170 mm
WEIGHT	1615 g
RACK-MOUNTABLE	Yes

LGCKZT000035 brown



DAISY

Front basket is a must-have for every urban cyclist. A safe place to stow your groceries and purse. The quick mounting system is compatible with all Le Grand baskets. Features the QUICK BRANCH system for quick handlebar mounting.

MATERIAL	Wire mesh
DIMENSIONS	345 x 250 x 260 mm
WEIGHT	1143 g
HANDLEBAR-MOUNTABLE	Yes

LGCKZT000030BK	black
LGCKZT000030WH	white

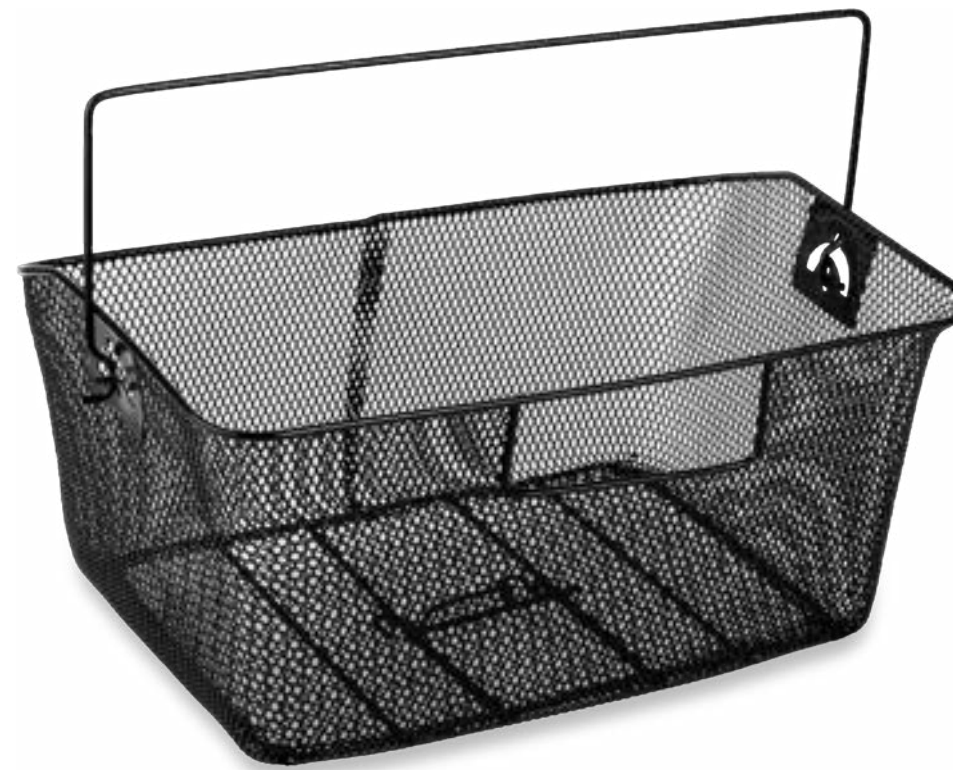

DAHLIA

Bicycle Basket, made from sturdy metal mesh. Additionally, its large capacity makes it very useful, as it can easily accommodate your personal belongings or groceries. Thanks to the classic attachment, attaching and removing the basket takes only a few seconds. The basket is mounted on the rear rack and comes with a securing handle.

MATERIAL	Wire mesh
DIMENSIONS	410 x 280 x 190 mm
WEIGHT	1670 g
RACK-MONTABLE	Yes

LGCKZT00039	black
--------------------	-------



COMPONENTS

MUDGUARDS





NEW

SLEEK 1.0

SLEEK 1.0 are mudguards designed for bicycles whose frame design makes it impossible to fit "standard" mudguards, both full-suspension MTBs and gravels on wide tyres. They perfectly protect against water and mud when riding off-road. They are made of flexible and UV-resistant plastic. Their underside is smooth for better mud evacuation. Their streamlined shape effectively minimises air resistance. The front mudguard is attached to the fork with adapters and 4 rubber O-rings. The rear mudguard is attached to the rear fork with adapters.

MATERIAL	ABS/TPE plastic
WHEEL SIZE	24"-29"
MAX. TYRE WIDTH	60 mm, ETRTO 60-622
MOUNTING	Front using a fork adapter Rear using rear fork adapters
WEIGHT	240 g

T4CBL290004BK black



NEW

SLENDER 1.0

SLENDER 1.0 are mudguards designed for road/gravel bikes, protecting against water and mud on wet asphalt and off-road. They are made of resistant plastic. Their underside is smooth for better mud evacuation. Their streamlined shape effectively minimises air resistance. The front mudguard is attached to the fork with adapters and 4 rubber O-rings. The rear mudguard is mounted to the upper fork with adjustable brackets.

MATERIAL	TPE plastic
WHEEL SIZE	28" 700C
MAX. TYRE WIDTH	45mm, ETRTO 45-622
MOUNTING	Front using a fork adapter Ø 80 - 140 mm Rear using rear fork adapters Ø 43 - 63
WEIGHT	148 g

T4CBL280062



NEW

SLENDER 2.0

SLENDER 2.0 are mudguards designed for MTB bikes, protecting against water and mud on wet asphalt and off-road. They are made of resistant plastic. Their underside is smooth for better mud evacuation. Their streamlined shape effectively minimises air resistance. The front mudguard is attached to the fork with adapters and 4 rubber O-rings. The rear mudguard is mounted using an adjustable clip. As a result, installation is quick and no tools are required.

MATERIAL	ABS/TPE plastic
WHEEL SIZE	24" - 29"
MAX. TYRE WIDTH	60 mm, ETRTO 63-622
MOUNTING	Front using a fork adapter Rear using a Q/R bracket to the seatpost
MAX. SEATPOST DIAMETER	35 mm
WEIGHT	240g

T4CBL290003BK



ADHD SDS

A set of ultra lightweight fenders with a unique design, made with the new generation of suspension bikes in mind. The front fender is attached with a special fastening to the fork, which allows for its vertical adjustment against the tire. In this way the fender turns together with the wheel, its fin constantly remaining close to the tire to ensure optimal protection during cycling. The rear fender boasts a contemporary design and convenient adjustment. Made for extreme off road experience. It's so versatile that it can be attached to the seatpost or lower, to the frame, with the use of a quick release clasp. A special construction and a double joint let you find the perfect fit to the frame and wheel. Wide fin ensures maximum protection when riding in any terrain.

MATERIAL	PP, PA, TPE
WHEEL SIZE	26-27.5"
MAX. TYRE WIDTH	70 mm, ETRTO 70-622
MOUNTING	Front: with the use of an adapter screwed-in to the fork crown Rear: with a quick release clasp attached to the seatpost
MAX SEATPOST DIAMETER	Uni
WEIGHT	340 g

T4CBL260152BKBK black / black



ADHD SDL

A set of ultra lightweight fenders with a unique design, made with the new generation of suspension bikes in mind. The front fender is attached with a special fastening to the fork, which allows for its vertical adjustment against the tire. In this way the fender turns together with the wheel, its fin constantly remaining close to the tire to ensure optimal protection during cycling. The rear fender boasts a contemporary design and convenient adjustment. Made for extreme off road experience. It's so versatile that it can be attached to the seatpost or lower, to the frame, with the use of a quick release clasp. A special construction and a double joint let you find the perfect fit to the frame and wheel. Wide fin ensures maximum protection when riding in any terrain.

MATERIAL	PP, PA, TPE
WHEEL SIZE	27.5-29"
MAX. TYRE WIDTH	70 mm, ETRTO 70-622
MOUNTING	Front: with the use of an adapter screwed-in to the fork crown Rear: with a quick release clasp attached to the seatpost
MAX SEATPOST DIAMETER	Uni
WEIGHT	370 g

T4CBL290001GYBK grey / black
T4CBL290002BKWH black / white



HARRIER II SDE

An advanced set of lightweight fenders designed for quick mounting and release with the use of special adapters will satisfy the most demanding needs for extreme rides in difficult terrain. The unique profile was designed with the latest generation bicycles with suspensions forks in mind. During the ride, the fender moves along with the wheel, maintaining a small clearance from the tire for optimum protection in any terrain. A special construction and a double joint in the rear fender allows for a perfect fit of the fender to the frame and wheel ergonomics.

MATERIAL	PP, PC
WHEEL SIZE	24-29"
MAX. TYRE WIDTH	70 mm, ETRTO 70-622
MOUNTING	Front: with the use of a SPEEDclick adapter screwed-in to the fork crown Rear: with a quick release SPEEDclasp attached to the seatpost
MAX SEATPOST DIAMETER	Uni
WEIGHT	365 g

T4CBL260157BK black



OSPREY II SDE

An all-purpose fender set for all types of bicycles. During the ride, the fender moves along with the wheel, maintaining a small clearance between its fin and the tire for optimum protection in any terrain. Double adjustment system for the best fit to the wheel size and frame type. A large surface of the fenders ensures optimal protection in any conditions.

MATERIAL	PP, PC
WHEEL SIZE	24-29"
MAX. TYRE WIDTH	55 mm, ETRTO 55-622
MOUNTING	Front: with the use of a SPEEDclick adapter screwed-in to the fork crown Rear: with a quick release clamp attached to the seatpost
MAX SEATPOST DIAMETER	Uni
WEIGHT	398 g

T4CBL260158BK black



MERLIN WIDE SDL

A set of fenders designed for low profile tires. For increased comfort, the fenders come with a state-of-the-art mounting system with the use of steel wires that ensure exceptional stability when riding. The fixed points of attachment let you forget about the fender once it is mounted. A perfect solution for all those who cycle to work in the morning sun and may be coming back in the rain.

MATERIAL	PP, TPE
WHEEL SIZE	28"
MAX. TYRE WIDTH	45 mm, ETRTO 42-622
MOUNTING	Front: to the front suspension fork booster or to the fork crown, with a sliding clamp Rear: to the upper frame support, with a sliding clamp, and to the lower support, with a screw Additionally both fenders are fixed with the use of side wires.
MAX TYRE WIDTH	50 mm
WEIGHT	434 g

T4CBL280061BK black
T4CBL280061GY grey



MERLIN SDS

A set of fenders designed for low profile tires. For increased comfort, the fenders come with a state-of-the-art mounting system with the use of steel wires that ensure exceptional stability when riding. The fixed points of attachment let you forget about the fender once it is mounted. A perfect solution for all those who cycle to work in the morning sun and may be coming back in the rain.

MATERIAL	PP, TPE
WHEEL SIZE	28"
MAX. TYRE WIDTH	40 mm, ETRTO 38-622
MOUNTING	Front: to the front suspension fork booster or to the fork crown, with a sliding clamp Rear: to the upper frame support, with a sliding clamp, and to the seatpost (up to 40 mm), with a silicone clamp Additionally both fenders are fixed with the use of side wires
MAX TYRE WIDTH	46 mm
WEIGHT	430 g

T4CBL280059BK black
T4CBL280059GY grey



MERLIN SDL

A set of fenders designed for low profile tires. For increased comfort, the fenders come with a state-of-the-art mounting system with the use of steel wires that ensure exceptional stability when riding. The fixed points of attachment let you forget about the fender once it is mounted. A perfect solution for all those who cycle to work in the morning sun and may be coming back in the rain.

MATERIAL	PP, TPE
WHEEL SIZE	28"
MAX. TYRE WIDTH	40 mm, ETRTO 38-622
MOUNTING	Front: to the front suspension fork booster or to the fork crown, with a sliding clamp Rear: to the upper frame support, with a sliding clamp, and to the lower support, with a screw Additionally both fenders are fixed with the use of side wires
MAX TYRE WIDTH	46 mm
WEIGHT	430 g

T4CBL280060BK	black
T4CBL280060GY	grey



CROW

The Crow rear fender is made of reinforced plastic. It is an indispensable bicycle accessory and thanks to its contemporary design, your bicycle will look even better. The SQR system makes attaching the fender a breeze. You can also adjust the bracket angle. This fender is suitable for bicycles with 24-29" wheel sizes. The Crow fender ensures easy maintenance and long service life. Easily detachable and folds flat for transport.

MATERIAL	PP
WHEEL SIZE	24-29"
MAX. TYRE WIDTH	55 mm, ETRTO 55-622
MOUNTING	To the seatpost, with the use of an adapter
MAX SEATPOST DIAMETER	Up to 32.5 mm
WEIGHT	156 g

T4CBL260153BK	black
----------------------	-------



ROOK

Lightweight fender from flexible plastic. The Rook fender by Kross is a must-have for every bike. Its design will make your bicycle look more attractive. You can easily attach it to the lower frame tube with flexible straps. Suitable for bicycles with 24-29" wheel sizes. Manufactured from reinforced plastic for easier maintenance and longer service life. Easily detachable and folds flat for transport.

MATERIAL	PP
WHEEL SIZE	24-29"
MAX. TYRE WIDTH	Universal
MOUNTING	With flexible bands to the lower frame tube
MAX SEATPOST DIAMETER	Uni
WEIGHT	77 g

T4CBL260154BK	black
----------------------	-------



HAWK

An all-purpose fender set for all types of bicycles. Double adjustment system for the best fit to the wheel size and frame type. A large surface of the fenders ensures optimal protection in any conditions. Self-cleaning and polished underside.

MATERIAL	PP, PC, ABS
WHEEL SIZE	24-29"
MAX. TYRE WIDTH	50 mm, ETRTO 47-622
MOUNTING	Front: to the frame, with Velcro straps Rear: to the seatpost, with the use of an adapter
MAX SEATPOST DIAMETER	32.8 mm
WEIGHT	331 g

T4CBL260150



KITE

A basic set of fenders designed for bicycles equipped with V-Brakes. The rear fender features a wide fin for increased protection against mud and the reflective element attached to it improves visibility and safety for the cyclist. Easy to mount and remove with the use of special adapters allows for a quick upgrade of the bike when the weather goes bad.

MATERIAL	PP
WHEEL SIZE	24-28"
MAX. TYRE WIDTH	48 mm, ETRTO 47-622
MOUNTING	Front: to the fork, with the use of an adapter Rear: to the frame, with the use of an adapter
MAX SEATPOST DIAMETER	35 mm
WEIGHT	260 g

T4CBL260151



TERN

A set of classic mountain bike fenders. These fenders are designed for bicycles equipped with V-Brakes. Easy to mount and remove with the use of special adapters allows for a quick upgrade of the bike when the weather goes bad.

MATERIAL	PP
WHEEL SIZE	24-26"
MAX. TYRE WIDTH	48 mm, ETRTO 47-559
MOUNTING	Front: to the fork, with the use of an adapter Rear: to the frame, with the use of an adapter
MAX SEATPOST DIAMETER	35 mm
WEIGHT	285 g

T4CBL240016



NEW



OSPREY V/B

Osprey V/B is a universal set of mudguards for MTB and ATB bikes equipped with V/B brakes. When cycling, the front mudguard turns with the wheel, so that its blade is at all times in close proximity to the tyre, providing optimum protection on any terrain. The two-point attachment to the frame provides outstanding structural stability and its shape is perfectly compatible with 26-29 inch wheels. The mudguards are equipped with reflective elements to improve the cyclist's visibility and safety. The large mudguard area provides optimum protection in all conditions.

MATERIAL	PP, PC
WHEEL SIZE	26-29"
MAX. TYRE WIDTH	58 mm
MOUNTING	Front using a SPEEDclick adapter screwed into the fork stem Rear to the upper frame bridge and the seat tube
MAX. SEATPOST DIAMETER	35 mm
WEIGHT	308 g

T4CBL280063



KIDO SDL

A set of fenders for 16" bicycles, featuring a unique design. The modern geometry ensures a perfect fit to the tire, which guarantees optimal protection against mud. The distinctive middle channel helps with the mounting, but also allows for the attachment of reflective elements for increased safety of your child. Additionally, the channel makes the fender highly rigid, eliminating vibrations in bumpy terrain. The front fender is attached to the front fork with an L-shaped steel plate that can be adjusted vertically and horizontally. The rear fender is attached to the bike with a screw at the end of the frame and with an L-shaped metal plate to the rear fork bar.

MATERIAL	PP
WHEEL SIZE	16"
MAX. TYRE WIDTH	60 mm, ETRTO 47-355
MOUNTING	Front: to the fork crown, with the use of an adapter Rear: to the top frame support, with the use of an adapter
WEIGHT	183 g

T4CBL160013



LARK

Fender set designed for the youngest cyclists who fancy fast rides through puddles. The Lark fenders are suitable for children's bicycles with wheel sizes between 16" and 20". They ensure comfort for the youngest cyclists while riding in rain and mud. With these fenders, kids can indulge in their passion and ride confidently, simply enjoying cycling.

MATERIAL	PP
WHEEL SIZE	16-20"
MAX. TYRE WIDTH	45 mm, ETRTO 45-507
MOUNTING	Front: to the fork, with the use of an adapter Rear: to the frame, with the use of an adapter
WEIGHT	138 g

T4CBL160012



KIDO SDE

A set of fenders for 20" bicycles, featuring a unique design. The modern geometry ensures a perfect fit to the tire, which guarantees optimal protection against mud. The distinctive middle channel helps with the mounting, but also allows for the attachment of reflective elements for increased safety of your child. Additionally, the channel makes the fender highly rigid, eliminating vibrations in bumpy terrain. The front fender is attached to the front fork with an L-shaped steel plate that can be adjusted vertically and horizontally. The rear fender is attached to the seatpost with the use of a modern mechanism that combines the advantages of a screwed clamp with the speed of a strap fastening.

MATERIAL	PP, PC, ABS
WHEEL SIZE	20"
MAX. TYRE WIDTH	63 mm, ETRTO 54-507
MOUNTING	Front: to the fork crown, with the use of an adapter Rear: to the seatpost, with the use of an adapter
WEIGHT	850 g

T4CBL200049



COMPONENTS

KICKSTANDS





EMARABOU

Durable, reinforced kickstand with a convenient wheel size adjustment system. Made of a lightweight aluminum alloy. Attached to the Direct Mount bracket, located on the inside of the rear triangle bottom tube. Ensures a stable position of the bike when stationary.

SIZE	Adjustable 24-29"
ATTACHMENT LOCATION	Rear triangle lower tube
MATERIAL	Aluminum
ADDITIONAL INFORMATION	Mount type for Kross frames with threaded holes in the rear triangle bottom tube (hole distance: 18 mm) Compatible with Kross frames featuring the Frame Direct Mount System Tool-free height adjustment
WEIGHT	305 g

T4CPK000180



MARABOU II

Durable kickstand with a convenient wheel size adjustment system. Made of a lightweight aluminum alloy. Attached to the rear fork tube with the use of the Direct Mount system. Ensures a stable position of the bike when stationary.

SIZE	Adjustable 24-29"
ATTACHMENT LOCATION	Rear triangle lower tube
MATERIAL	Aluminum
ADDITIONAL INFORMATION	Mount type for frames with threaded holes in the rear triangle bottom tube (hole distance: 18 mm) Compatible with Kross frames featuring the Frame Direct Mount system Tool-free height adjustment
WEIGHT	260 g

T4CPK000175



HERON III

Durable kickstand with a convenient wheel size adjustment system and variable rear triangle angle. Made of a lightweight aluminum alloy. Ensures a stable position of the bike when stationary.

SIZE	Adjustable 24-29"
ATTACHMENT LOCATION	Frame rear fork
MATERIAL	Aluminum
ADDITIONAL INFORMATION	Universal mount for frames of various rear triangle angles Tool-free height adjustment
WEIGHT	402 g

T4CPK000177



CRANE II

Durable kickstand with a convenient wheel size adjustment system. Attached to the rear triangle bottom tube of oval and square shapes. Made of a lightweight aluminum alloy. Ensures a stable position of the bike when stationary.

SIZE	Adjustable 24-29"
ATTACHMENT LOCATION	Rear triangle lower tube
MATERIAL	Aluminum
ADDITIONAL INFORMATION	Tool-free height adjustment
WEIGHT	320 g

T4CPK000172



STORK II

Durable kickstand with a convenient wheel size adjustment system. Central mount behind the bottom bracket. Made of a lightweight aluminum alloy. Ensures a stable position of the bike when stationary.

SIZE	Adjustable 24-28"
ATTACHMENT LOCATION	Central, behind the bottom bracket
MATERIAL	Aluminum
ADDITIONAL INFORMATION	Tool-free height adjustment
WEIGHT	310 g

T4CPK000173



LEVER 2.0

Durable kickstand with a convenient wheel size adjustment system and variable rear triangle angle. Made of a lightweight aluminum alloy. Ensures a stable position of the bike when stationary.

SIZE	Adjustable 24-29"
ATTACHMENT LOCATION	Frame rear fork
MATERIAL	Aluminum
ADDITIONAL INFORMATION	Universal mount for frames of various rear triangle angles
	Tool-free height adjustment
WEIGHT	366 g

T4CPK000178



LEVER 1.0

Durable kickstand with a convenient wheel size adjustment system. Central mount behind the bottom bracket. Made of a lightweight aluminum alloy. Ensures a stable position of the bike when stationary.

SIZE	Adjustable 24-28"
ATTACHMENT LOCATION	Central, behind the bottom bracket
MATERIAL	Aluminum
ADDITIONAL INFORMATION	
	Tool-free height adjustment
WEIGHT	252 g

T4CPK000179



LITTLE EGERT

Kickstand designed for children's bicycles, with a convenient wheel size adjustment system. Central mount behind the bottom bracket. Made of a lightweight aluminum alloy. Ensures a stable position of the bike when stationary.

SIZE	Adjustable 16-24"
ATTACHMENT LOCATION	Central, behind the bottom bracket
MATERIAL	Aluminum
ADDITIONAL INFORMATION	
	Tool-free height adjustment
WEIGHT	263 g

T4CPK000176



TOP PLATE

An adapter that fixes the central kickstand behind the bottom bracket.

MATERIAL	Aluminum / steel
ADDITIONAL INFORMATION	2-inch screw included

T4CIN000017

COMPONENTS



GRIPS & BAR TAPES



SILKY

Grips made of silicone foam to ensure maximum shock absorption. Thanks to their plasticity, the grips perfectly adjust to the shape of your hands. Easy to maintain. Plugs included.

MATERIAL	Silicone foam
LENGTH	129 mm
WEIGHT	81 g (pair)

T4CCH000269BK	black
T4CCH000269RD	red



ENDURO PRO

Grips made of a durable and comfortable compound, with a low and aggressive texture. The hard core perfectly adheres to handlebars, preventing the grips from slipping. The aluminum o-rings ensure firm attachment to handlebars. Plugs included.

MATERIAL	Kraton / PP
LENGTH	148 mm
WEIGHT	151 g (pair)

T4CCH000285BK	black
T4CCH000285RD	red
T4CCH000285GR	green



STABLE 3.0

Grips made of a durable and comfortable compound, with a low and aggressive texture. The hard core perfectly adheres to handlebars, preventing the grips from slipping. The aluminum o-rings ensure firm attachment to handlebars. Plugs included.

MATERIAL	Kraton / PP
LENGTH	140 mm
WEIGHT	124 g (pair)

T4CCH000287BK	black
T4CCH000287RD	red
T4CCH000287GY	grey
T4CCH000287BL	blue



CERTAIN 3.0

Grips made of a durable and comfortable compound, with a low and aggressive texture. The hard core perfectly adheres to handlebars, preventing the grips from slipping. The aluminum o-ring ensures firm attachment to handlebars. Plugs included.

MATERIAL	Kraton / PP
LENGTH	135 mm
WEIGHT	108 g (pair)

T4CCH000288BK	black
T4CCH000288RD	red



SEMI ERGO

Comfortable and durable grips made of two types of rubber compound. Ergonomic shape of the grip reduces pressure on the hand's nerves.

MATERIAL	Kraton / PP
LENGTH	134 mm
WEIGHT	140 g (pair)

T4CCH000289WH	white
T4CCH000289RD	red
T4CCH000289GY	grey



ERGO 2.0

Comfortable grips made of two types of rubber compound that combine ultimate durability with convenience of use. The carefully designed grip shape improves the ergonomics and decreases the pressure of handlebars. A single aluminum o-ring ensures firm attachment to handlebars. Plugs included.

MATERIAL	Kraton / PP
LENGTH	130 mm
WEIGHT	166 g (pair)

T4CCH000286GY	grey
T4CCH000286BK	black



SCALE 2.0

Grips made of a durable and comfortable rubber compound, with the use of the Double Density technology. The materials used increase the comfort of the grip and reduce vibrations.

MATERIAL	Kraton / PP
LENGTH	135 mm
WEIGHT	128 g (pair)

T4CCH000290BK	black
T4CCH000290RD	red
T4CCH000290GY	grey
T4CCH000290GR	green
T4CCH000290BL	blue



SCALE

Grips made of a durable and comfortable rubber compound, with the use of the Double Density technology. The materials used increase the comfort of the grip and reduce vibrations.

MATERIAL	Kraton / PP
LENGTH	130 mm
WEIGHT	120 g (pair)

T4CCH000268BL	blue
T4CCH000268GY	grey
T4CCH000268RD	red
T4CCH000268WH	white



ULTRA FOAM

Grips made of the ultra light EVA foam. Chosen by professionals. Ergonomic profile ensure comfort of use. Plugs included.

MATERIAL	EVA foam
LENGTH	127 mm
WEIGHT	51 g (pair)

T4CCH000270BK	black
----------------------	-------



TACKY

Silicone bar tape. Stretchable and flexible. Perfectly absorbs vibrations transmitted to handlebars. Due to the high tensile strength, the tape can be easily wrapped around the handlebars. Easy to use. Plugs included.

MATERIAL	Silicone
LENGTH	1800 x 30 mm
WEIGHT	179 g (set)

T4CCH000275BK black



COBWEB

Tape made of EVA foam and polyurethane. Perfectly absorbs vibrations transmitted to handlebars. Due to the high tensile strength, the tape can be easily wrapped around the handlebars. The top layer ensures a pleasant and comfortable grip, while the inner one absorbs vibrations. Plugs included.

MATERIAL	EVA foam / PU
LENGTH	1900 x 30 mm
WEIGHT	74 g (set)

T4CCH000276BK black



INBORN

Tape made of EVA foam. Perfectly absorbs vibrations transmitted to handlebars. Due to the high tensile strength, the tape can be easily wrapped around the handlebars. Other features: resistant to low temperatures, resistant to cracking, waterproof and UV-ray proof. Plugs included.

MATERIAL	EVA foam
LENGTH	1900 x 30 mm
WEIGHT	45 g (set)

T4CCH000277BK black

COMPONENTS



SADDLES



TR 3.1

Comfortable gel saddle covered with artificial leather to provide a high level of comfort even during long rides. Two layers of filling ensure a more even body weight distribution and improve the absorption of shocks generated by surface bumps. Gel inserts reduce pressure on ischium and pubis. The Double Density shell combines flexibility and comfort. The groove in the center of the shell decreases pressure on vulnerable body parts and doesn't hinder blood circulation. The ArcTech technology makes the saddle more flexible, improving its shock-absorbing properties and your comfort. Steel rails feature a scale, which makes it easier to adjust the saddle height on the seatpost.

SHELL	Double Density
PADDING	Gel Padding
RAILS	Steel with a scale
TECHNOLOGIES	ArcTech, Zone Cut
DIMENSIONS	282 x 188 mm
WEIGHT	587 g

T4CSI000880BK black



TR 4.1

Comfortable gel saddle covered with artificial leather to provide a high level of comfort even during long rides. Two layers of filling ensure a more even body weight distribution and improve the absorption of shocks generated by surface bumps. Gel inserts reduce pressure on ischium and pubis. The Double Density shell combines flexibility and comfort. The groove in the center of the shell decreases pressure on vulnerable body parts and doesn't hinder blood circulation. The ArcTech technology makes the saddle more flexible, improving its shock-absorbing properties and your comfort. Steel rails feature a scale, which makes it easier to adjust the saddle height on the seatpost.

SHELL	Double Density
PADDING	Gel Padding
RAILS	Steel with a scale
TECHNOLOGIES	ArcTech, Zone Cut
DIMENSIONS	270 x 213 mm
WEIGHT	558 g

T4CSI000881BK black



TR 3.0

A comfortable saddle made of a high density foam. Covered with artificial leather to provide comfort even during long rides. Two layers of filling ensure a more even body weight distribution and improve the absorption of shocks generated by surface bumps. The Double Density shell combines flexibility and comfort. The groove in the center of the shell decreases pressure on vulnerable body parts and doesn't hinder blood circulation. The ArcTech technology makes the saddle more flexible, improving its shock-absorbing properties and your comfort. Steel rails feature a scale, which makes it easier to adjust the saddle height on the seatpost.

SHELL	Double Density
PADDING	High Density
RAILS	Steel with a scale
TECHNOLOGIES	ArcTech, Zone Cut
DIMENSIONS	282 x 188 mm
WEIGHT	514 g

T4CSI000882BK black



TR 4.0

A comfortable saddle made of a high density foam. Covered with artificial leather to provide comfort even during long rides. Two layers of filling ensure a more even body weight distribution and improve the absorption of shocks generated by surface bumps. The Double Density shell combines flexibility and comfort. The groove in the center of the shell decreases pressure on vulnerable body parts and doesn't hinder blood circulation. The ArcTech technology makes the saddle more flexible, improving its shock-absorbing properties and your comfort. Steel rails feature a scale, which makes it easier to adjust the saddle height on the seatpost.

SHELL	Double Density
PADDING	High Density
RAILS	Steel with a scale
TECHNOLOGIES	ArcTech, Zone Cut
DIMENSIONS	270 x 213 mm
WEIGHT	558 g

T4CSI000883BK black



TR 1.0

A comfortable saddle made of a high density foam. Covered with artificial leather joined seamlessly to provide comfort even during long rides. Two layers of filling ensure a more even body weight distribution and improve the absorption of shocks generated by surface bumps. The Double Density shell combines flexibility and comfort. The groove in the center of the shell decreases pressure on vulnerable body parts and doesn't hinder blood circulation. The ArcTech technology makes the saddle more flexible, improving its shock-absorbing properties and your comfort. Steel rails feature a scale, which makes it easier to adjust the saddle height on the seatpost.

SHELL	Double Density
PADDING	High Density
RAILS	Steel with a scale
TECHNOLOGIES	ArcTech, Zone Cut
DIMENSIONS	282 x 172 mm
WEIGHT	411 g

T4CSI000878BK black



TR 2.0

A comfortable saddle made of a high density foam. Covered with artificial leather joined seamlessly to provide comfort even during long rides. Two layers of filling ensure a more even body weight distribution and improve the absorption of shocks generated by surface bumps. The Double Density shell combines flexibility and comfort. The groove in the center of the shell decreases pressure on vulnerable body parts and doesn't hinder blood circulation. The ArcTech technology makes the saddle more flexible, improving its shock-absorbing properties and your comfort. Steel rails feature a scale, which makes it easier to adjust the saddle height on the seatpost.

SHELL	Double Density
PADDING	High Density
RAILS	Steel with a scale
TECHNOLOGIES	ArcTech, Zone Cut
DIMENSIONS	262 x 192 mm
WEIGHT	452 g

T4CSI000879BK black



JR 1.0

A comfortable saddle made of a high density foam. Covered with artificial leather joined seamlessly to provide comfort even during long rides. The ArcTech technology makes the saddle more flexible, improving its shock-absorbing properties and your comfort. The groove in the center decreases pressure on vulnerable body parts and doesn't hinder blood circulation. Steel rails feature a scale, which makes it easier to adjust the saddle height on the seatpost.

SHELL	Single Density
PADDING	High Density
RAILS	Steel with a scale
TECHNOLOGIES	ArcTech, Zone Cut
DIMENSIONS	258 x 135 mm
WEIGHT	297 g

T4CSI000886BKAQ	black / aquamarine
T4CSI000886BKPI	black / pink



JR 2.0

A comfortable saddle made of a high density foam. Covered with artificial leather joined seamlessly to provide comfort even during long rides. The ArcTech technology makes the saddle more flexible, improving its shock-absorbing properties and your comfort. Steel rails feature a scale, which makes it easier to adjust the saddle height on the seatpost.

SHELL	Single Density
PADDING	High Density
RAILS	Steel with a scale
TECHNOLOGIES	ArcTech
DIMENSIONS	255 x 128 mm
WEIGHT	274 g

T4CSI000887BKRD	black / red
T4CSI000887GYGY	grey / grey



KID 2.0

A comfortable saddle designed for children's bikes, made of a high density foam. Covered with artificial leather to provide comfort even during long rides. The ArcTech technology makes the saddle more flexible, improving its shock-absorbing properties and your comfort.

SHELL	Single Density
PADDING	High Density
RAILS	Steel
TECHNOLOGIES	ArcTech
DIMENSIONS	207 x 146 mm
WEIGHT	276 g

T4CSI000889GYBK	grey / grey
T4CSI000889GYBL	grey / blue



KID 1.0

A comfortable saddle designed for children's bikes, made of a high density foam. Covered with artificial leather to provide comfort even during long rides. The ArcTech technology makes the saddle more flexible, improving its shock-absorbing properties and your comfort.

SHELL	Single Density
PADDING	High Density
RAILS	Steel
TECHNOLOGIES	ArcTech
DIMENSIONS	207 x 146 mm
WEIGHT	276 g

T4CSI000888BKAQ	black / aquamarine
T4CSI000888BKPI	black / pink



COMPONENTS

PEDALS





TRIAL

Durable pedals made of reinforced plastic, made for those who are starting their MTB / ENDURO / TRIAL bicycle adventure. Longer platform ensures stable foot support while cycling.

USE	MTB / ENDURO / TRIAL
MATERIAL	Body: plastic Axle: 7 mm boron steel 8 aluminum pins
BEARING TYPE	Plain (ZU System)
ADDITIONAL ELEMENTS	Side reflectors
PLATFORM DIMENSIONS	90 x 84 mm
WEIGHT	292 g / pair

T4CPE000243



STARTER 2.0

Durable MTB bicycle pedals. The right design of the aluminum cage guarantees a good shoe grip.

USE	MTB
MATERIAL	Body: aluminum Cage: aluminum Axle: 7 mm boron steel
BEARING TYPE	Plain (ZU System)
ADDITIONAL ELEMENTS	Side reflectors
PLATFORM DIMENSIONS	95 x 63 mm
WEIGHT	278 g / pair

T4CPE000242



BEGGINER 2.0

Durable MTB bicycle pedals. The right design of the aluminum cage guarantees a good shoe grip.

USE	MTB
MATERIAL	Body: plastic Cage: aluminum Axle: 7 mm boron steel
BEARING TYPE	Ball
ADDITIONAL ELEMENTS	Side reflectors
PLATFORM DIMENSIONS	90 x 70 mm
WEIGHT	306 g / pair

T4CPE000241



STANDARD 3.0

Durable pedals made of plastic. Designed for MTB and Trekking bikes. The right design of the platform guarantees a good shoe grip.

USE	MTB / Trekking
MATERIAL	Body: plastic Cage: plastic composite Axle: steel
BEARING TYPE	Ball
ADDITIONAL ELEMENTS	Side reflectors
PLATFORM DIMENSIONS	95 x 75 mm
WEIGHT	312 g / pair

T4CPE000240



URBAN POLIMER

City bicycle pedals, made of aluminum and plastic, with an anti-slip finish to ensure a good shoe grip. Integrated reflective elements improve the user's visibility on the road.

USE	City
MATERIAL	Body: aluminum, plastic Axle: 7 mm Cr-Mo steel
BEARING TYPE	Plain (ZU System)
ADDITIONAL ELEMENTS	Side reflectors
PLATFORM DIMENSIONS	85 x 73 mm
WEIGHT	298 g / pair

T4CPE000245



CITY ANTYSLIP

City bicycle pedals, made of plastic, with an anti-slip finish to ensure a good shoe grip. Integrated reflective elements improve the user's visibility on the road.

USE	City
MATERIAL	Body: plastic Axle: 7 mm boron steel
BEARING TYPE	Ball
ADDITIONAL ELEMENTS	Side reflectors
PLATFORM DIMENSIONS	96 x 85 mm
WEIGHT	323 g / pair

T4CPE000244



COMPONENTS

CHAINS

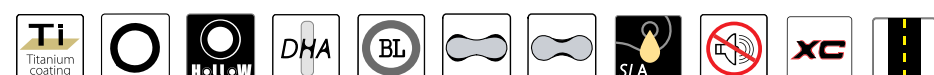

CHAIN SLA1210-TIG

This chain is intended for 12-speed cassettes, coated with titanium nitride. Extremely durable, maintains its characteristics for up to 8000 kilometers. Drilled pins and plates for lower weight. Pins and rollers reinforced with chromium carbide. The SLA technology nearly doubles the chain's service life. The unique chain plate finishing process ensures smooth and quick gear shifts. The chain generates less friction, works more quietly and its smooth surface attracts less dirt.

USE	MTB/ Road
SPEEDS	12
FINISH	Golden
WEIGHT	275 g
WIDTH	5.2 mm
NUMBER OF LINKS	126L
COMPATIBILITY	Shimano, Campagnolo and Sram

T4CLA000183



CHAIN S12-S2

This chain is intended for 12-speed cassettes. Very durable, maintains its characteristics for up to 3000 kilometers. Drilled pins and plates for lower weight. Pins and rollers reinforced with chromium carbide. The SLA technology nearly doubles the chain's service life. The unique chain plate finishing process ensures smooth and quick gear shifts. The chain generates less friction, works more quietly and its smooth surface attracts less dirt.

USE	MTB/ Road
SPEEDS	12
FINISH	Silver
WEIGHT	285 g
WIDTH	5.2 mm
NUMBER OF LINKS	126L
COMPATIBILITY	Shimano, Campagnolo and Sram

T4CLA000185



CHAIN SLA110 TI-N GOLD

This chain is intended for 11-speed cassettes, coated with titanium nitride. Extremely durable, maintains its characteristics for up to 8000 kilometers. Drilled pins and plates for lower weight. Pins and rollers reinforced with chromium carbide. The SLA technology nearly doubles the chain's service life. The unique chain plate finishing process ensures smooth and quick gear shifts. The chain generates less friction, works more quietly and its smooth surface attracts less dirt.

USE	MTB/ Road
SPEEDS	11
FINISH	Golden
WEIGHT	245 g
WIDTH	5.6 mm
NUMBER OF LINKS	116L
COMPATIBILITY	Shimano, Campagnolo and Sram

T4CLA000192

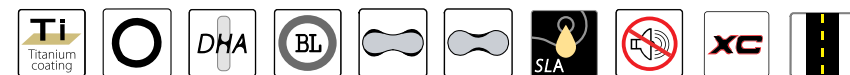

CHAIN SLA-H11 TI-N GOLD

This chain is intended for 11-speed cassettes, coated with titanium nitride. Very durable, maintains its characteristics for up to 3000 kilometers. Pins and rollers reinforced with chromium carbide. The SLA technology nearly doubles the chain's service life. The unique chain plate finishing process ensures smooth and quick gear shifts. The chain generates less friction, works more quietly and its smooth surface attracts less dirt.

USE	MTB/ Road
SPEEDS	11
FINISH	Golden
WEIGHT	255 g
WIDTH	5.6 mm
NUMBER OF LINKS	166L
COMPATIBILITY	Shimano, Campagnolo and Sram

T4CLA000186



CHAIN S11-S2

This chain is intended for 11-speed cassettes. Very durable, maintains its characteristics for up to 3000 kilometers. Pins and rollers reinforced with chromium carbide. The unique chain plate finishing process ensures smooth and quick gear shifts. The chain generates less friction, works more quietly and its smooth surface attracts less dirt.

USE	MTB/ Road
SPEEDS	11
FINISH	Silver
WEIGHT	265 g
WIDTH	5.6 mm
NUMBER OF LINKS	116L
COMPATIBILITY	Shimano, Campagnolo and Sram

T4CLA000193

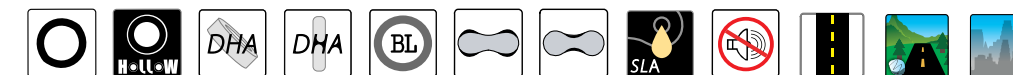

CHAIN SLA101 S2

This chain is intended for 10-speed cassettes. Very durable, maintains its characteristics for up to 8000 kilometers. Pins and rollers reinforced with chromium carbide. The SLA technology nearly doubles the chain's service life. The unique chain plate finishing process ensures smooth and quick gear shifts. The chain generates less friction, works more quietly and its smooth surface attracts less dirt.

USE	MTB/ Road
SPEEDS	10
FINISH	Silver
WEIGHT	250 g
WIDTH	5.9 mm
NUMBER OF LINKS	116L
COMPATIBILITY	Shimano, Campagnolo and Sram

T4CLA000194

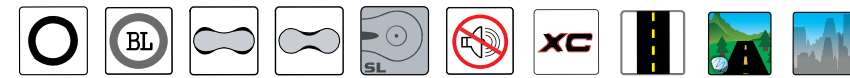

CHAIN SH10 S

This chain is intended for 10-speed cassettes. Extremely durable, maintains its characteristics for up to 4500 kilometers. Drilled outer plates for lower weight. Pins and rollers reinforced with chromium carbide.

USE	MTB/ Road
SPEEDS	10
FINISH	Half Nickel Plated (silver/grey)
WEIGHT	266 g
WIDTH	5.9 mm
NUMBER OF LINKS	116L
COMPATIBILITY	Shimano, Campagnolo and Sram

T4CLA000174

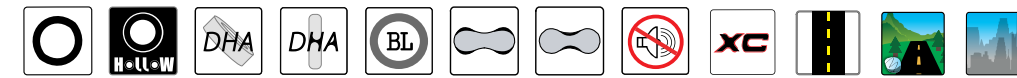

CHAIN S10 S2

This chain is intended for 10-speed cassettes. Very durable, maintains its characteristics for up to 3000 kilometers. Pins and rollers reinforced with chromium carbide. The unique chain plate finishing process ensures smooth and quick gear shifts. The chain generates less friction, works more quietly and its smooth surface attracts less dirt.

USE	MTB/ Road
SPEEDS	10
FINISH	Silver
WEIGHT	270 g
WIDTH	5.9 mm
NUMBER OF LINKS	116L
COMPATIBILITY	Shimano, Campagnolo and Sram

T4CLA000195

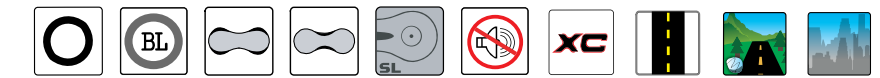

CHAIN SH9S

This chain is intended for 9-speed cassettes. Extremely durable, maintains its characteristics for up to 4500 kilometers. Pins and rollers reinforced with chromium carbide. Reinforced plates.

USE	Trekking / MTB/ Road
SPEEDS	9
FINISH	(grey/grey)
WEIGHT	320 g
WIDTH	6.4 mm
NUMBER OF LINKS	116L
COMPATIBILITY	Shimano, Campagnolo and Sram

T4CLA000172



CHAIN S9

This chain is intended for 9-speed cassettes. Extremely durable, maintains its characteristics for up to 4500 kilometers. Pins and rollers reinforced with chromium carbide.

USE	TREKKING / MTB/ ROAD
SPEEDS	9
FINISH	Nickel Plated (silver/silver)
WEIGHT	283 g
WIDTH	6.4 mm
NUMBER OF LINKS	116L
COMPATIBILITY	Shimano, Campagnolo and Sram

T4CLA000173



CHAIN S8 S2

This chain is intended for 8-speed cassettes. Extremely durable, maintains its characteristics for up to 3000 kilometers. Reinforced plates.

USE	TREKKING / MTB
SPEEDS	8
FINISH	Nickel Plated (silver/silver)
WEIGHT	348 g
WIDTH	7.3 mm
NUMBER OF LINKS	116L
COMPATIBILITY	Shimano, Campagnolo and Sram

T4CLA000170

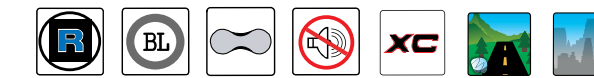

CHAIN 7/8S

This chain is intended for 7- and 8-speed cassettes. Extremely durable, reinforced plates and pins.

USE	TREKKING / CITY
SPEEDS	7/8
FINISH	(brown/brown)
WEIGHT	344 g
WIDTH	7.3 mm
NUMBER OF LINKS	116L
COMPATIBILITY	Shimano, Campagnolo and Sram

T4CLA000168



CHAIN 6/7S

This chain is intended for 6- and 7-speed cassettes. Extremely durable, reinforced plates and pins.

USE	TREKKING / CITY
SPEEDS	6/7
FINISH	(navy blue/brown)
WEIGHT	348 g
WIDTH	7.3 mm
NUMBER OF LINKS	116L
COMPATIBILITY	Shimano, Campagnolo and Sram

T4CLA000167



CHAIN SINGLE

This chain is intended for single-speed drivetrains. Extremely durable, reinforced plates and pins.

USE	CITY
SPEEDS	1
FINISH	(brown/brown)
WEIGHT	354 g
WIDTH	8.6 mm
NUMBER OF LINKS	116L
COMPATIBILITY	Shimano and Sram

T4CLA000166

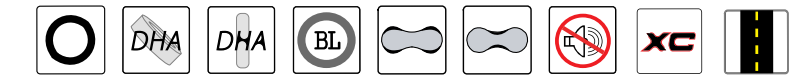

CHAIN S11E-S2

This chain is intended for 11-speed cassettes. Specially reinforced for e-bikes. Very durable, maintains its characteristics for up to 3000 kilometers. Drilled pins reinforced with chromium carbide. The unique chain plate finishing process ensures smooth and quick gear shifts. The chain generates less friction, works more quietly and its smooth surface attracts less dirt.

USE	e-BIKE
SPEEDS	11
FINISH	Silver
WEIGHT	280 g
WIDTH	5.6 mm
NUMBER OF LINKS	122L
COMPATIBILITY	Shimano, Campagnolo and Sram

T4CLA000187

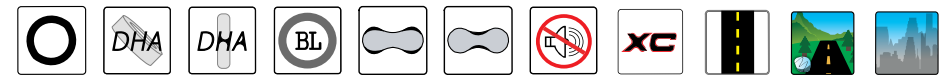

















CHAIN S10E-S2

This chain is intended for 10-speed cassettes. Specially reinforced for e-bikes. Very durable, maintains its characteristics for up to 3000 kilometers. Drilled pins reinforced with chromium carbide. The unique chain plate finishing process ensures smooth and quick gear shifts. The chain generates less friction, works more quietly and its smooth surface attracts less dirt.

USE	e-BIKE
SPEEDS	10
FINISH	Silver
WEIGHT	285 g
WIDTH	5,9 mm
NUMBER OF LINKS	122L
COMPATIBILITY	Shimano, Campagnolo and Sram

T4CLA000188

	TITANIUM COATING	A titanium nitride coating (Ti-N) guarantees maximum chain durability in any conditions.
		Circle riveting is a technology that extremely prolongs the service life of pins.
		Drilled pins lower the weight by 20%, as compared to full pins, without compromising their durability.
	DHA ROLLER	A roller reinforced with a chromium carbide coating
	DHA PIN	A pin reinforced with a chromium carbide coating, protects against rust and abrasion
	BL	This technology ensures an easy and gentle chain operation during gear shifting.
	IC	A proper finish of the inner and outer connectors reduces chain suck
	OC	A proper finish of the outer plate edges reduces friction by up to 80% when shifting gears
	NS	A very quiet chain operation, also during gear shifting
	SR	Riveted for enhanced durability.
	SL	Laser cut outer plates of the chain reduce its weight and ensure greater durability and efficiency.
	SUPERIOR LUBRICATING AID	A special Ni-PTFE coating reduces friction and nearly doubles the chain's service life.
	CROSS COUNTRY	
	ROAD	
	TREKKING	
	CITY	



Q/R 12S BUCKLE

A chain buckle designed for connecting 12-speed chains. It is very durable and reusable. Compatible with Campagnolo, Shimano and Sram.

SPEEDS	12
FINISH	Silver
WEIGHT	30 g / 6 pcs in a box
WIDTH	5.9 mm

T4CLA000190



Q/R 11S BUCKLE

A chain buckle designed for connecting 11-speed chains. It is very durable and reusable. Compatible with Campagnolo, Shimano and Sram.

SPEEDS	11
FINISH	Silver
WEIGHT	30 g / 6 pcs in a box
WIDTH	5.9 mm

T4CLA000191



Q/R 10S BUCKLE

A chain buckle designed for connecting 10-speed chains. It is very durable and reusable. The QRS system guarantees a safe and comfortable ride.

SPEEDS	10
FINISH	Nickel Plated (silver)
WEIGHT	30 g
WIDTH	5.9 mm

T4CLA000075



Q/R 9S BUCKLE

A chain buckle designed for connecting 9-speed chains. It is very durable and reusable. The QRS system guarantees a safe and comfortable ride.

SPEEDS	9
FINISH	Nickel Plated (silver)
WEIGHT	30 g
WIDTH	6.4 mm

T4CLA000074



Q/R 8S BUCKLE

A chain buckle designed for connecting 7- and 8-speed chains. It is very durable and reusable. The QRS system guarantees a safe and comfortable ride. Coated with chromium carbide for durability.

SPEEDS	7/8
FINISH	Nickel Plated (silver)
WEIGHT	30 g
WIDTH	7.5 mm

T4CLA000073

COMPONENTS

WHEELS





29" BOOST FRONT I DISC

DIAMETER	29"
VERSION	Front
NUMBER OF HOLES	32
MATERIAL	Aluminum
RIM PROFILE	Low cone
COMPATIBLE BRAKES	Disc Brake
ISO DISC MOUNT	6 screws
FINISH	Standard
AXLE	BOOST 15 x 110 mm
HUB MODEL	Shimano HB-MT400-B
COLOR	Black

T4CKO290006BKP black



29" BOOST REAR I DISC

DIAMETER	29"
VERSION	Rear
NUMBER OF HOLES	32
MATERIAL	Aluminum
RIM PROFILE	Low cone
COMPATIBLE BRAKES	Disc Brake
ISO DISC MOUNT	6 screws
FINISH	Standard
AXLE	BOOST E-THRU 12 x 148 mm
HUB TYPE	Cassette
HUB MODEL	Shimano FH-MT400-B
COLOR	Black

T4CKO290004BKP black



29" MTB FRONT I DISC

DIAMETER	29"
VERSION	Front
NUMBER OF HOLES	32
MATERIAL	Aluminum
RIM PROFILE	Low cone, double-walled
COMPATIBLE BRAKES	Disc Brake
FINISH	Standard
AXLE	9 mm (3/8)
ACCESSORIES	Quick release
ISO DISC MOUNT	6 screws
COLOR	Black

T4CKO290001BKP black



29" MTB REAR I DISC

DIAMETER	29"
VERSION	Rear
NUMBER OF HOLES	32
MATERIAL	Aluminum
RIM PROFILE	Single-walled
COMPATIBLE BRAKES	Disc Brake
FINISH	Standard
AXLE	10 mm (3/8)
HUB TYPE	Freewheel
COLOR	Black
ISO DISC MOUNT	6 screws

T4CKO290003BKP black



29" MTB XC FRONT I DISC

DIAMETER	29"
VERSION	Front
NUMBER OF HOLES	32
MATERIAL	Aluminum
RIM PROFILE	Low cone
COMPATIBLE BRAKES	Disc Brake
ISO DISC MOUNT	6 screws
FINISH	Standard
AXLE	E-THRU 15 x 100 mm
HUB MODEL	Shimano HB-MT400-B
COLOR	Black

T4CKO290007BKP black



29" MTB XC REAR I DISC

DIAMETER	29"
VERSION	Rear
NUMBER OF HOLES	32
MATERIAL	Aluminum
RIM PROFILE	Low cone
COMPATIBLE BRAKES	Disc Brake
ISO DISC MOUNT	6 screws
FINISH	Standard
AXLE	E-THRU 12 x 142 mm
HUB TYPE	Cassette
HUB MODEL	Shimano FH-MT400
COLOR	Black

T4CKO290005BKP black



29" MTB REAR II DISC

DIAMETER	29"
VERSION	Rear
NUMBER OF HOLES	32
MATERIAL	Aluminum
RIM PROFILE	Low cone, double-walled
COMPATIBLE BRAKES	Disc Brake
FINISH	Standard
AXLE	9 mm (3/8)
HUB TYPE	Cassette
ACCESSORIES	Quick release
ISO DISC MOUNT	6 screws
COLOR	Black

T4CKO290002BKP black



700C ROAD FRONT I

DIAMETER	700C
NUMBER OF HOLES	32
MATERIAL	Aluminum
RIM PROFILE	Low cone, double-walled
COMPATIBLE BRAKES	Rim brakes
FINISH	Turned rim
AXLE	9 mm (3/8)
ACCESSORIES	Quick release
COLOR	Black

T4CKO280057BKP black



700C GRAVEL REAR I DISC

DIAMETER	700C
VERSION	Rear
NUMBER OF HOLES	32
MATERIAL	Aluminum
RIM PROFILE	Low cone
COMPATIBLE BRAKES	Disc Brake
ISO DISC MOUNT	6 screws
FINISH	Standard
AXLE	9 x 135 mm
HUB MODEL	Shimano FH-M3050
ACCESSORIES	Quick release
COLOR	Black

T4CKO280061BKP black



700C GRAVEL FRONT I DISC

DIAMETER	700C
VERSION	Front
NUMBER OF HOLES	32
MATERIAL	Aluminum
RIM PROFILE	Low cone
COMPATIBLE BRAKES	Disc Brake
FINISH	Standard
AXLE	9 x 100 mm
HUB MODEL	Shimano M3050
COLOR	Black

T4CKO280060BKP black



28" CITY FRONT I

DIAMETER	28"
VERSION	Front
NUMBER OF HOLES	32
MATERIAL	Aluminum
RIM PROFILE	High cone, double-walled
COMPATIBLE BRAKES	V-brake
FINISH	Turned rim
AXLE	10 mm (3/8)
ACCESSORIES	Washers and nuts
COLOR	Silver

T4CKO280051SIP silver



28" CITY FRONT II

DIAMETER	28"
VERSION	Front
NUMBER OF HOLES	32
MATERIAL	Aluminum
RIM PROFILE	High cone, double-walled
COMPATIBLE BRAKES	V-brake
FINISH	Turned rim
AXLE	10 mm (3/8)
HUB	Shimano with an integrated dynamo
ACCESSORIES	Washers and nuts, plug
COLOR	Black

T4CKO280059BKP black



28" TRK FRONT I

DIAMETER	28"
VERSION	Front
NUMBER OF HOLES	32
MATERIAL	Aluminum
RIM PROFILE	High cone, double-walled
COMPATIBLE BRAKES	V-brake
FINISH	Turned rim
AXLE	10 mm (3/8)
ACCESSORIES	Washers and nuts
COLOR	Black

T4CKO280049BKP black



28" TRK REAR I

DIAMETER	28"
VERSION	Rear
NUMBER OF HOLES	32
MATERIAL	Rim and hub made of aluminum
RIM PROFILE	High cone, double-walled
COMPATIBLE BRAKES	V-brake
FINISH	Turned rim
AXLE	10 mm (3/8)
HUB TYPE	Freewheel
ACCESSORIES	Washers and nuts
COLOR	Black

T4CKO280050BKP black



28" TRK FRONT II

DIAMETER	28"
VERSION	Front
NUMBER OF HOLES	32
MATERIAL	Aluminum
RIM PROFILE	High cone, double-walled
COMPATIBLE BRAKES	V-brake
FINISH	Turned rim
AXLE	9 mm (3/8)
ACCESSORIES	Quick release
COLOR	Black

T4CKO280053BKP black



28" TRK REAR II

DIAMETER	28"
VERSION	Rear
NUMBER OF HOLES	32
MATERIAL	Aluminum
RIM PROFILE	High cone, double-walled
COMPATIBLE BRAKES	V-brake
FINISH	Turned rim
AXLE	9 mm (3/8)
HUB TYPE	Cassette
ACCESSORIES	Quick release
COLOR	Black

T4CKO280054BKP black



27.5" MTB XC FRONT I DISC

DIAMETER	27.5"
VERSION	Front
NUMBER OF HOLES	32
MATERIAL	Aluminum
RIM PROFILE	Low cone, double-walled
COMPATIBLE BRAKES	Disc Brake
FINISH	Standard
AXLE	9 mm (3/8)
ACCESSORIES	Quick release
ISO DISC MOUNT	6 screws
COLOR	Black

T4CKO275001BKP black



27.5" MTB XC REAR I DISC

DIAMETER	27.5"
VERSION	Rear
NUMBER OF HOLES	32
MATERIAL	Aluminum
RIM PROFILE	Low cone, double-walled
COMPATIBLE BRAKES	Disc Brake
FINISH	Standard
AXLE	9 mm (3/8)
HUB TYPE	Cassette
ACCESSORIES	Quick release
ISO DISC MOUNT	6 screws
COLOR	Black

T4CKO275002BKP black



27.5" MTB REAR I DISC

DIAMETER	27.5"
VERSION	Rear
NUMBER OF HOLES	32
MATERIAL	Aluminum
RIM PROFILE	High cone, double-walled
COMPATIBLE BRAKES	Disc Brake
FINISH	Standard
AXLE	10 mm (3/8)
HUB TYPE	Freewheel
ACCESSORIES	Quick release
ISO DISC MOUNT	6 screws
COLOR	Black

T4CKO275003BKP black



26" MTB FRONT I

DIAMETER	26"
VERSION	Front
NUMBER OF HOLES	32
MATERIAL	Rim and hub made of aluminum
RIM PROFILE	High cone, double-walled
COMPATIBLE BRAKES	V-brake
FINISH	Turned rim
AXLE	10 mm (3/8)
ACCESSORIES	Washers and nuts
COLOR	Black

T4CKO260049BKP black



26" MTB REAR I

DIAMETER	26"
VERSION	Rear
NUMBER OF HOLES	32
MATERIAL	Rim and hub made of aluminum
RIM PROFILE	High cone, double-walled
COMPATIBLE BRAKES	V-brake
FINISH	Turned rim
AXLE	10 mm (3/8)
HUB TYPE	Freewheel
ACCESSORIES	Washers and nuts
COLOR	Black

T4CKO260050BKP black



26" MTB FRONT II

DIAMETER	26"
VERSION	Front
NUMBER OF HOLES	32
MATERIAL	Rim and hub made of aluminum
RIM PROFILE	High cone, double-walled
COMPATIBLE BRAKES	V-brake
FINISH	Turned rim
AXLE	10 mm (3/8)
ACCESSORIES	Washers and nuts
COLOR	Silver

T4CKO260051SIP silver



26" MTB REAR II

DIAMETER	26"
VERSION	Rear
NUMBER OF HOLES	32
MATERIAL	Rim and hub made of aluminum
RIM PROFILE	High cone, double-walled
COMPATIBLE BRAKES	V-brake
FINISH	Turned rim
AXLE	10 mm (3/8)
HUB TYPE	Freewheel
ACCESSORIES	Washers and nuts
COLOR	Silver

T4CKO260052SIP silver



26" MTB FRONT III

DIAMETER	26"
VERSION	Front
NUMBER OF HOLES	32
MATERIAL	Aluminum
RIM PROFILE	High cone, double-walled
COMPATIBLE BRAKES	V-brake
FINISH	Turned rim
AXLE	9 mm (3/8)
ACCESSORIES	Quick release
COLOR	Black

T4CKO260054BKP black



26" MTB REAR III

DIAMETER	26"
VERSION	Rear
NUMBER OF HOLES	32
MATERIAL	Aluminum
RIM PROFILE	High cone, double-walled
COMPATIBLE BRAKES	V-brake
FINISH	Turned rim
AXLE	9 mm (3/8)
HUB TYPE	Cassette
ACCESSORIES	Quick release
COLOR	Black

T4CKO260055BKP black



26" MTB XC FRONT I DISC

DIAMETER	26"
VERSION	Front
NUMBER OF HOLES	32
MATERIAL	Aluminum
RIM PROFILE	Low cone, double-walled
COMPATIBLE BRAKES	Disc Brake
FINISH	Standard
AXLE	9 mm (3/8)
ACCESSORIES	Quick release
ISO DISC MOUNT	6 screws
COLOR	Black

T4CKO260056BKP black



26" MTB XC REAR I DISC

DIAMETER	26"
VERSION	Rear
NUMBER OF HOLES	32
MATERIAL	Aluminum
RIM PROFILE	Low cone, double-walled
COMPATIBLE BRAKES	Disc Brake
FINISH	Standard
AXLE	9 mm (3/8)
HUB TYPE	Cassette
ACCESSORIES	Quick release
ISO DISC MOUNT	6 screws
COLOR	Black

T4CKO260057BKP black



26" MTB REAR IV DISC

DIAMETER	26"
VERSION	Rear
NUMBER OF HOLES	32
MATERIAL	Aluminum
RIM PROFILE	High cone, double-walled
COMPATIBLE BRAKES	Disc Brake
FINISH	Standard
AXLE	10 mm (3/8)
HUB TYPE	Freewheel
ACCESSORIES	Quick release
ISO DISC MOUNT	6 screws
COLOR	Black

T4CKO260065BKP black



26" CITY FRONT I

DIAMETER	26"
VERSION	Front
NUMBER OF HOLES	32
MATERIAL	Aluminum
RIM PROFILE	Single-walled
COMPATIBLE BRAKES	V-Brake
FINISH	Standard
AXLE	10 mm (3/8)
ACCESSORIES	Washers and nuts
COLOR	Silver

T4CKO260062SIP silver



26" CITY REAR I

DIAMETER	26"
VERSION	Rear
NUMBER OF HOLES	32
MATERIAL	Rim - aluminum; hub - steel
RIM PROFILE	High cone, double-walled
COMPATIBLE BRAKES	V-brake
FINISH	Turned rim
AXLE	10 mm (3/8)
HUB TYPE	Coaster brake
ACCESSORIES	Washers and nuts, hub set
COLOR	Silver

T4CKO260053SIP silver



26" CITY FRONT II

DIAMETER	26"
VERSION	Front
NUMBER OF HOLES	32
MATERIAL	Aluminum
RIM PROFILE	High cone, double-walled
COMPATIBLE BRAKES	V-brake
FINISH	Turned rim
AXLE	10 mm (3/8)
HUB	Shimano with an integrated dynamo
ACCESSORIES	Washers and nuts, plug
COLOR	Silver

T4CKO260064SIP silver



26" CITY REAR III

DIAMETER	26"
VERSION	Rear
NUMBER OF HOLES	32
MATERIAL	Aluminum
RIM PROFILE	Single-walled
COMPATIBLE BRAKES	V-brake
FINISH	Turned rim
AXLE	10 mm (3/8)
HUB TYPE	Freewheel
ACCESSORIES	Washers and nuts
COLOR	Silver

T4CKO260063SIP silver



24" JR. MTB FRONT I

DIAMETER	24"
VERSION	Front
NUMBER OF HOLES	32
MATERIAL	Rim and hub made of aluminum
RIM PROFILE	High cone, double-walled
COMPATIBLE BRAKES	V-brake
FINISH	Turned rim
AXLE	10 mm (3/8)
ACCESSORIES	Washers and nuts
COLOR	Black

T4CKO240044BKP black



24" JR. MTB REAR I

DIAMETER	24"
VERSION	Rear
NUMBER OF HOLES	32
MATERIAL	Rim and hub made of aluminum
RIM PROFILE	High cone, double-walled
COMPATIBLE BRAKES	V-brake
FINISH	Turned rim
AXLE	10 mm (3/8)
HUB TYPE	Freewheel
ACCESSORIES	Washers and nuts
COLOR	Black

T4CKO240045BKP black



24" CITY FRONT I

DIAMETER	24"
VERSION	Front
NUMBER OF HOLES	32
MATERIAL	Rim and hub made of aluminum
RIM PROFILE	High cone, double-walled
COMPATIBLE BRAKES	V-brake
FINISH	Turned rim
AXLE	10 mm (3/8)
ACCESSORIES	Washers and nuts
COLOR	Silver

T4CKO240046SIP silver

COMPONENTS

TYRES & TUBES





SATURN RING

SATURN RING is a gravel tire with great grip. The hexagonal blocks allow you to enjoy outstanding traction on paved roads, in mud or on gravel.

SIZE	700 x 38C (ETRTO 40-622)
CONSTRUCTION	Pro
COMPOUND	Basic Compound
COLOR	Black
MAX PRESSURE	80 PSI (5.5 Bar)
WEIGHT	415 g

T4COP700013



SATURN RING

SATURN RING is a gravel tire with great grip. The hexagonal blocks allow you to enjoy outstanding traction on paved roads, in mud or on gravel.

SIZE	700 x 38C (ETRTO 40-622)
COMPOUND	Basic Compound
COLOR	Black
MAX PRESSURE	80 PSI (5.5 Bar)
LOAD BEARING CAPACITY	80 kg
WEIGHT	590 g

T4COP700012



SATURN RING

SATURN RING is a gravel tire with great grip. The hexagonal blocks allow you to enjoy outstanding traction on paved roads, in mud or on gravel.

SIZE	700 x 35C (ETRTO 37-622)
COMPOUND	Basic Compound
COLOR	Black
MAX PRESSURE	80 PSI (5.5 Bar)
LOAD BEARING CAPACITY	80 kg
WEIGHT	475 g

T4COP700010



NEW

PANGOLIN

Pangolin is a gravel tyre that is specially designed to provide excellent performance on gravel and dirt terrain. Its unique design and tread characteristics make it an ideal choice for cyclists looking for a reliable tyre for long and demanding gravel rides. The Pangolin tyre provides excellent grip, traction, and comfort, giving you confidence on any terrain.

SIZE	700X45C (ETRTO 47-622)
RUBBER COMPOUND	Basic Compound
COLOUR VERSION	Black
MAX. PRESSURE	65 PSI (4.5 Bar)
PERMISSIBLE LOAD	100 kg
WEIGHT	563 g

T4COP700020



NEW

PANGOLIN

Pangolin is a gravel tyre that is specially designed to provide excellent performance on gravel and dirt terrain. Its unique design and tread characteristics make it an ideal choice for cyclists looking for a reliable tyre for long and demanding gravel rides. The Pangolin tyre provides excellent grip, traction, and comfort, giving you confidence on any terrain.

SIZE	700X38C (ETRTO 40-622)
RUBBER COMPOUND	Basic Compound
COLOUR VERSION	Black
MAX. PRESSURE	80 PSI (5.5 Bar)
PERMISSIBLE LOAD	80 kg
WEIGHT	554 g

T4COP700021



PALADIN

70% on the path and 30% off path. Paladin combines the efficiency of smooth tires intended for road bikes with a lumpy tread pattern that lets you ride on in any conditions.

SIZE	700 x 38C (ETRTO 38-622)
COMPOUND	Basic Compound
COLOR	Black
MAX PRESSURE	80 PSI (5.5 Bar)
LOAD BEARING CAPACITY	80 kg
WEIGHT	528 g

T4COP700011



TOUCH DOWN

TOUCH DOWN is a tire that will surely help you to succeed in any race, thanks to the combination of a silica compound and a rough surface.

SIZE	700 x 23 (ETRTO 23-622)
CONSTRUCTION	Pro
COMPOUND	Basic Compound
COLOR	Black
MAX PRESSURE	120 PSI (8.3 Bar)
LOAD BEARING CAPACITY	60 kg
WEIGHT	238 g

T4COP700008



PANTHER

PANTHER is a pure-bred XC tire. The low block pattern and 30 TPI wire bead allows you to ride through forest paths with maximum speed and efficiency.

SIZE	26" x 1.95 (ETRTO 47-559)
CONSTRUCTION	Classic
COMPOUND	Basic Compound
COLOR	Black
MAX PRESSURE	60 PSI (4.1 Bar)
LOAD BEARING CAPACITY	90 kg
WEIGHT	495 g

T4COP260227



X-METEOR

The dense pattern of the METEOR XC tires allows you to achieve the best possible contact with the surface, both on paved roads and off-road

SIZE	27.5" x 2.10 (ETRTO 54-584)
CONSTRUCTION	Classic
COMPOUND	Basic Compound
COLOR	Black
MAX PRESSURE	60 PSI (4.1 Bar)
LOAD BEARING CAPACITY	105 kg
WEIGHT	770 g

T4COP275015

odor



MIKE BEAR

MIKE BEAR was designed for MTB bikes and features a 2-3-2 block pattern for good traction on hard surfaces.

SIZE	27.5" x 2.25 (ETRTO 57-584)
CONSTRUCTION	Classic
COMPOUND	Dual Compound
COLOR	Black
MAX PRESSURE	52 PSI (3.5 Bar)
LOAD BEARING CAPACITY	110 kg
WEIGHT	969 g

T4COP275017





MIKE BEAR

MIKE BEAR was designed for MTB bikes and features a 2-3-2 block pattern for good traction on hard surfaces.

SIZE	26" x 2.25 (ETRTO 57-559)
CONSTRUCTION	Classic
COMPOUND	Dual Compound
COLOR	Black
MAX PRESSURE	60 PSI (4.1 Bar)
LOAD BEARING CAPACITY	105 kg
WEIGHT	870 g

T4COP260232



JUMPING HARE

JUMPING HARE is a fast enduro tire. It will take you through all those forest paths, mountainsides and valleys, will let you feel the maximum acceleration, fast sprints and lots of fun on the trail.

SIZE	26" x 2.25 (ETRTO 57-559)
CONSTRUCTION	Classic
COMPOUND	Dual Compound
COLOR	Black
MAX PRESSURE	52 PSI (3.5 Bar)
LOAD BEARING CAPACITY	105 kg
WEIGHT	945 g

T4COP260233



JUMPING HARE

JUMPING HARE is a fast enduro tire. It will take you through all those forest paths, mountainsides and valleys, will let you feel the maximum acceleration, fast sprints and lots of fun on the trail.

SIZE	27.5" x 2.25 (ETRTO 57-584)
CONSTRUCTION	Classic
COMPOUND	Dual Compound
COLOR	Black
MAX PRESSURE	52 PSI (3.5 Bar)
LOAD BEARING CAPACITY	110 kg
WEIGHT	980 g

T4COP275018



JUMPING HARE

JUMPING HARE is a fast enduro tire. It will take you through all those forest paths, mountainsides and valleys, will let you feel the maximum acceleration, fast sprints and lots of fun on the trail.

SIZE	29" x 2.35 (ETRTO 60-622)
CONSTRUCTION	Pro
COMPOUND	Basic Compound
COLOR	Black
MAX PRESSURE	55 PSI (3.8 Bar)
LOAD BEARING CAPACITY	140 kg
WEIGHT	1110 g

T4COP290020



KEEN WOLF

KEEN WOLF was designed for those in search of light and fast XC tires that offer good traction, thanks to the blocks located on the outer edges.

SIZE	29" x 2.00 (ETRTO 50-622)
CONSTRUCTION	Pro
COMPOUND	Basic Compound
COLOR	Black
MAX PRESSURE	60 PSI (4.1 Bar)
LOAD BEARING CAPACITY	100 kg
WEIGHT	530 g

T4COP290018



KEEN WOLF

KEEN WOLF was designed for those in search of light and fast XC tires that offer good traction, thanks to the blocks located on the outer edges.

SIZE	29" x 2.00 (ETRTO 50-622)
CONSTRUCTION	Classic
COMPOUND	Basic Compound
COLOR	Black
MAX PRESSURE	60 PSI (4.1 Bar)
LOAD BEARING CAPACITY	100 kg
WEIGHT	685 g

T4COP290017



KEEN WOLF

KEEN WOLF was designed for those in search of light and fast XC tires that offer good traction, thanks to the blocks located on the outer edges.

SIZE	27.5" x 1.95 (ETRTO 50-584)
CONSTRUCTION	Classic
COMPOUND	Basic Compound
COLOR	Black
MAX PRESSURE	60 PSI (4.1 Bar)
LOAD BEARING CAPACITY	95 kg
WEIGHT	665 g

T4COP275014

KEEN WOLF

KEEN WOLF was designed for those in search of light and fast XC tires that offer good traction, thanks to the blocks located on the outer edges.

SIZE	26" x 1.95 (ETRTO 50-559)
CONSTRUCTION	Classic
COMPOUND	Basic Compound
COLOR	Black
MAX PRESSURE	60 PSI (4.1 Bar)
LOAD BEARING CAPACITY	90 kg
WEIGHT	605 g

T4COP260228

BILLY GOAT

BILLY GOAT is an XC tire that can be used by beginners. Lightweight and fast, with low rolling resistance and an efficient, mud-evacuating tread.

SIZE	29" x 2.00 (ETRTO 50-622)
CONSTRUCTION	Classic
COMPOUND	Basic Compound
COLOR	Black
MAX PRESSURE	60 PSI (4.1 Bar)
LOAD BEARING CAPACITY	100 kg
WEIGHT	725 g

T4COP290016



BILLY GOAT

BILLY GOAT is an XC tire that can be used by beginners. Lightweight and fast, with low rolling resistance and an efficient, mud-evacuating tread.

SIZE	27.5" x 2.10 (ETRTO 54-584)
CONSTRUCTION	Classic
COMPOUND	Basic Compound
COLOR	Black
MAX PRESSURE	60 PSI (4.1 Bar)
LOAD BEARING CAPACITY	105 kg
WEIGHT	770 g

T4COP275016



BILLY GOAT

BILLY GOAT is an XC tire that can be used by beginners. Lightweight and fast, with low rolling resistance and an efficient, mud-evacuating tread.

SIZE	27.5" x 1.95 (ETRTO 50-584)
CONSTRUCTION	Classic
COMPOUND	Basic Compound
COLOR	Black
MAX PRESSURE	60 PSI (4.1 Bar)
LOAD BEARING CAPACITY	95 kg
WEIGHT	665 g

T4COP275013



BILLY GOAT

BILLY GOAT is an XC tire that can be used by beginners. Lightweight and fast, with low rolling resistance and an efficient, mud-evacuating tread.

SIZE	26" x 2.10 (ETRTO 54-559)
CONSTRUCTION	Classic
COMPOUND	Basic Compound
COLOR	Black
MAX PRESSURE	60 PSI (4.1 Bar)
LOAD BEARING CAPACITY	90 kg
WEIGHT	735 g

T4COP260231



NIMBLE BEN

NIMBLE BEN is a tire created by enthusiasts for enthusiasts. The low tread profile will handle any terrain and conditions during a race. It ensures an outstanding grip.

SIZE	29" x 1.95 (ETRTO 50-622)
CONSTRUCTION	Classic
COMPOUND	Basic Compound
COLOR	Black
LOAD BEARING CAPACITY	100 kg
WEIGHT	965 g

T4COP290015



NIMBLE BEN

NIMBLE BEN is a tire created by enthusiasts for enthusiasts. The low tread profile will handle any terrain and conditions during a race. It ensures an outstanding grip.

SIZE	26" x 2.10 (ETRTO 54-559)
CONSTRUCTION	Classic
COMPOUND	Basic Compound
COLOR	Black
LOAD BEARING CAPACITY	100 kg
WEIGHT	917 g

T4COP260229



TIGHT JOHN

TIGHT JOHN is a great allroad tire that maintains a good rolling resistance performance. Its classic tread pattern is highly resistant to wear.

SIZE	26" x 2.10 (ETRTO 54-559)
CONSTRUCTION	Classic
COMPOUND	Basic Compound
COLOR	Black
LOAD BEARING CAPACITY	90 kg
WEIGHT	897 g

T4COP260230



SLEEK

SLEEK is not a typical semi-slick tire, apart from the centrally located, low-profile tread, it also features long driving blocks that bite into the ground, as well as prominent and aggressively arranged blocks on the outer edge. The tread has a low rolling resistance and good grip.

SIZE	26" x 1.95 (ETRTO 47-559)
CONSTRUCTION	Classic
COMPOUND	Basic Compound
COLOR	Black
LOAD BEARING CAPACITY	90 kg
WEIGHT	917 g

T4COP260226



SPIKY THORN

SPIKY THORN features a directional, very densely arranged and low tread pattern that reduces the rolling resistance. Its rubber is fast and great for hardened dirt paths.

SIZE	24" x 2.35 (ETRTO 60-507)
CONSTRUCTION	Classic
COMPOUND	Basic Compound
COLOR	Black
LOAD BEARING CAPACITY	90 kg
WEIGHT	892 g

T4COP240069



SHARP CUT

SHARP CUT is a classic semi-slick tire with low-profile, inward-facing teeth to improve speed. Ensures low rolling resistance and maximum grip on racing routes.

SIZE	24" x 1.95 (ETRTO 50-507)
CONSTRUCTION	Classic
COMPOUND	Basic Compound
COLOR	Black
LOAD BEARING CAPACITY	90 kg
WEIGHT	765 g

T4COP240067



ANGRY BILL

ANGRY BILL features a directional and low tread pattern that reduces the rolling resistance. Its rubber is fast and great for hardened dirt paths.

SIZE	20" x 1.95 (ETRTO 47-406)
CONSTRUCTION	Classic
COMPOUND	Basic Compound
COLOR	Black
LOAD BEARING CAPACITY	75 kg
WEIGHT	647 g

T4COP200055



METRO ELITE

METRO ELITE is your ticket from start to finish. This durable tire with low rolling resistance is a perfect choice for those city cyclists who want to rely on their bikes, whatever the weather.

SIZE	26" x 1.75 (ETRTO 47-559)
CONSTRUCTION	Classic
COMPOUND	Basic Compound
COLOR	Black
MAX PRESSURE	65 PSI (4.1 Bar)
LOAD BEARING CAPACITY	85 kg
WEIGHT	805 g

T4COP260223



METRO ELITE

METRO ELITE is your ticket from start to finish. This durable tire with low rolling resistance is a perfect choice for those city cyclists who want to rely on their bikes, whatever the weather.

SIZE	700 x 35C (ETRTO 37-622)
COMPOUND	Basic Compound
COLOR	Black
MAX PRESSURE	80 PSI (5.5 Bar)
LOAD BEARING CAPACITY	70 kg
WEIGHT	715 g

T4COP280096



METRO ELITE

METRO ELITE is your ticket from start to finish. This durable tire with low rolling resistance is a perfect choice for those city cyclists who want to rely on their bikes, whatever the weather.

SIZE	28" x 1.75 (ETRTO 47-622)
CONSTRUCTION	Classic
COMPOUND	Basic Compound
COLOR	Black
LOAD BEARING CAPACITY	80 kg
WEIGHT	655 g

T4COP280098



METRO ELITE

METRO ELITE is your ticket from start to finish. This durable tire with low rolling resistance is a perfect choice for those city cyclists who want to rely on their bikes, whatever the weather.

SIZE	700 x 35C (ETRTO 37-622)
CONSTRUCTION	Classic
COMPOUND	Basic Compound
COLOR	Black
MAX PRESSURE	80 PSI (5.5 Bar)
LOAD BEARING CAPACITY	100 kg
WEIGHT	850 g

T4COP280101



TRAVELLER

TRAVELLER is an all-purpose tire suitable for many types of conditions, from city paths to off-road tracks.

SIZE	28" x 1.60 (ETRTO 42-622)
CONSTRUCTION	Classic
COMPOUND	Basic Compound
COLOR	Black
MAX PRESSURE	80 PSI (5.5 Bar)
LOAD BEARING CAPACITY	70 kg
WEIGHT	746 g

T4COP280097



SLIDE RIDE

SLIDE RIDE is a tire for city and trekking bikes, with deep grooves that evacuate water. Very low rolling resistance makes it a great choice for city bikes.

SIZE	12 1/2" x 2 1/4 (ETRTO 62-203)
CONSTRUCTION	Classic
COMPOUND	Basic Compound
COLOR	Black
LOAD BEARING CAPACITY	40 kg
WEIGHT	373 g

T4COP120013



SLIDE RIDE

SLIDE RIDE is a tire for city and trekking bikes, with deep grooves that evacuate water. Very low rolling resistance makes it a great choice for city bikes.

SIZE	16" x 1.75 (ETRTO 47-305)
CONSTRUCTION	Classic
COMPOUND	Basic Compound
COLOR	Black
LOAD BEARING CAPACITY	50 kg
WEIGHT	428 g

T4COP160033



SLIDE RIDE

SLIDE RIDE is a tire for city and trekking bikes, with deep grooves that evacuate water. Very low rolling resistance makes it a great choice for city bikes.

SIZE	20" x 1.75 (ETRTO 47-406)
CONSTRUCTION	Classic
COMPOUND	Basic Compound
COLOR	Black
LOAD BEARING CAPACITY	65 kg
WEIGHT	570 g

T4COP200054



SLIDE RIDE

SLIDE RIDE is a tire for city and trekking bikes, with deep grooves that evacuate water. Very low rolling resistance makes it a great choice for city bikes.

SIZE	28" x 1.75 (ETRTO 47-622)
CONSTRUCTION	Classic
COMPOUND	Basic Compound
COLOR	Brown
MAX PRESSURE	65 PSI (4.1 Bar)
LOAD BEARING CAPACITY	100 kg
WEIGHT	937 g

T4COP280100



SLIDE RIDE

SLIDE RIDE is a tire for city and trekking bikes, with deep grooves that evacuate water. Very low rolling resistance makes it a great choice for city bikes.

SIZE	28" x 1.75 (ETRTO 47-622)
CONSTRUCTION	Classic
COMPOUND	Basic Compound
COLOR	Black
LOAD BEARING CAPACITY	100 kg
WEIGHT	910 g

T4COP280099



SILENT NOISE

SILENT NOISE is a tire for city and trekking bikes, with deep grooves that evacuate water. Very low rolling resistance makes it a great choice for city bikes.

SIZE	24" x 1.75 (ETRTO 47-507)
CONSTRUCTION	Classic
COMPOUND	Basic Compound
COLOR	Black
LOAD BEARING CAPACITY	80 kg
WEIGHT	798 g

T4COP240068



SILENT NOISE

SILENT NOISE is a tire for city and trekking bikes, with deep grooves that evacuate water. Very low rolling resistance makes it a great choice for city bikes.

SIZE	26" x 1.75 (ETRTO 47-559)
CONSTRUCTION	Classic
COMPOUND	Basic Compound
COLOR	Brown
LOAD BEARING CAPACITY	85 kg
WEIGHT	861 g

T4COP260224



LAZY JACK

LAZY JACK is a tire for city and trekking bikes, with deep grooves that evacuate water. Very low rolling resistance makes it a great choice for city bikes.

SIZE	26" x 1.75 (ETRTO 47-559)
CONSTRUCTION	Classic
COMPOUND	Basic Compound
COLOR	Cream
LOAD BEARING CAPACITY	85 kg
WEIGHT	731 g

T4COP260225



TIVER 200

A set of 3 tire levers that help to remove tire from the rim. When removing a tire, you can hook one lever onto a spoke and then use another lever for easy removal. Made of durable plastic.

T4CKW000027BK	black
T4CKW000027GR	green
T4CKW000027GY	grey
T4CKW000027OR	orange
T4CKW000027RD	red



29" PRESTA LONG 4

Butyl rubber-based inner tube for guaranteed air tightness, with very good flexibility parameters and wear resistance.

SIZE	29" x 2.10 - 3.00
VALVE	F/V L-47 mm
WEIGHT	364 g +/- 5%

T4CDE290017



29"/28" DUNLOP LONG 1

Butyl rubber-based inner tube for guaranteed air tightness, with very good flexibility parameters and wear resistance.

SIZE	28"/29" x 1.90 - 2.35
VALVE	D/V L-40 mm
WEIGHT	230 g +/- 5%

T4CDE290014



29"/28" PRESTA LONG 4

Butyl rubber-based inner tube for guaranteed air tightness, with very good flexibility parameters and wear resistance.

SIZE	28"/29" x 1.90 - 2.35
VALVE	F/V L-47 mm
WEIGHT	230 g +/- 5%

T4CDE290015



29"/28" SCHRADER SUPER LONG 2

Butyl rubber-based inner tube for guaranteed air tightness, with very good flexibility parameters and wear resistance.

SIZE	28"/29" x 1.90 - 2.35
VALVE	A/V L-48 mm
WEIGHT	230 g +/- 5%

T4CDE290016



28" PRESTA LONG

Butyl rubber-based inner tube for guaranteed air tightness, with very good flexibility parameters and wear resistance.

SIZE	28" x 1.5 - 1.90
VALVE	F/V L-47 mm
WEIGHT	222 g +/- 5%

T4CDE280054



28" SCHRADER SUPER LONG

Butyl rubber-based inner tube for guaranteed air tightness, with very good flexibility parameters and wear resistance.

SIZE	28" x 1.5 - 1.90
VALVE	A/V L-48 mm
WEIGHT	222 g +/- 5%

T4CDE280055



700C PRESTA LONG 13

Butyl rubber-based inner tube for guaranteed air tightness, with very good flexibility parameters and wear resistance.

SIZE	700 x 35/38C
VALVE	F/V L-47 mm
WEIGHT	170 g +/- 5%

T4CDE280058



700C PRESTA LONG 12

Butyl rubber-based inner tube for guaranteed air tightness, with very good flexibility parameters and wear resistance.

SIZE	700 x 18/25C
VALVE	F/V L-47 mm
WEIGHT	125 g +/- 5%

T4CDE280056



700C SCHRADER SUPER LONG

Butyl rubber-based inner tube for guaranteed air tightness, with very good flexibility parameters and wear resistance.

SIZE	700 x 35/38C
VALVE	A/V L-48 mm
WEIGHT	170 g +/- 5%

T4CDE280057



27,5" PRESTA LONG 5

Butyl rubber-based inner tube for guaranteed air tightness, with very good flexibility parameters and wear resistance.

SIZE	27.5" x 2.10 - 3.00
VALVE	F/V L-47 mm
WEIGHT	245 g +/- 5%

T4CDE270018



27,5" PRESTA LONG 6

Butyl rubber-based inner tube for guaranteed air tightness, with very good flexibility parameters and wear resistance.

SIZE	27.5" x 1.95 - 2.125
VALVE	F/V L-47 mm
WEIGHT	220 g +/- 5%

T4CDE270017



26" PRESTA LONG 5

Butyl rubber-based inner tube for guaranteed air tightness, with very good flexibility parameters and wear resistance.

SIZE	26" x 1.75 - 2.125
VALVE	F/V L-47 mm
WEIGHT	201 g +/- 5%

T4CDE260082



26" DUNLOP LONG 5

Butyl rubber-based inner tube for guaranteed air tightness, with very good flexibility parameters and wear resistance.

SIZE	26" x 1.75 - 2.125
VALVE	D/V L-40 mm
WEIGHT	201 g +/- 5%

T4CDE260081



26" SCHRADER S. LONG 2

Butyl rubber-based inner tube for guaranteed air tightness, with very good flexibility parameters and wear resistance.

SIZE	26" x 1.75 - 2.125
VALVE	A/V L-48 mm
WEIGHT	201 g +/- 5%

T4CDE260080



24" SCHRADER SUPER LONG 2

Butyl rubber-based inner tube for guaranteed air tightness, with very good flexibility parameters and wear resistance.

SIZE	24" x 1.75 - 2.125
VALVE	A/V L-48 mm
WEIGHT	185 g +/- 5%

T4CDE240043



24" DUNLOP LONG 4

Butyl rubber-based inner tube for guaranteed air tightness, with very good flexibility parameters and wear resistance.

SIZE	24" x 1.75 - 2.45
VALVE	D/V L-40 mm
WEIGHT	163 g +/- 5%

T4CDE240042



24" DUNLOP LONG 5

Butyl rubber-based inner tube for guaranteed air tightness, with very good flexibility parameters and wear resistance.

SIZE	24" x 1.75 - 2.125
VALVE	D/V L-40 mm
WEIGHT	185 g +/- 5%

T4CDE240044



20" SCHRADER LONG 5

Butyl rubber-based inner tube for guaranteed air tightness, with very good flexibility parameters and wear resistance.

SIZE	20" x 1.75 - 2.125
VALVE	A/V L-40 mm
WEIGHT	146 g +/- 5%

T4CDE200035



16" SCHRADER STAND 5

Butyl rubber-based inner tube for guaranteed air tightness, with very good flexibility parameters and wear resistance.

SIZE	16" x 1.75 - 2.125
VALVE	A/V L-35 mm
WEIGHT	116 g +/- 5%

T4CDE160026



16" DUNLOP STAND 5

Butyl rubber-based inner tube for guaranteed air tightness, with very good flexibility parameters and wear resistance.

SIZE	16" x 1.75 - 2.125
VALVE	D/V L-35 mm
WEIGHT	116 g +/- 5%

T4CDE160025



12" DUNLOP STANDARD

Butyl rubber-based inner tube for guaranteed air tightness, with very good flexibility parameters and wear resistance.

SIZE	12 1/2" x 2 1/4
VALVE	D/V L-35 mm
WEIGHT	95 g +/- 5%

T4CDE120022



12" SCHRADER STAND 4

Butyl rubber-based inner tube for guaranteed air tightness, with very good flexibility parameters and wear resistance.

SIZE	12 1/2" x 2 1/4
VALVE	A/V L-35 mm
WEIGHT	95 g +/- 5%

T4CDE120021

COMPONENTS

BRAKE PADS

BOOST 12x148



BP-DM-5

Durable brake pads designed for disc brakes. Reliable in any conditions. They will satisfy even the most demanding users.

COMPATIBILITY	Avid Elixir R, 3, 5, Sram XX
LINING TYPE	Metallic pads

T4CHA000759



DP-DM-2

Durable brake pads designed for disc brakes. Reliable in any conditions. They will satisfy even the most demanding users.

COMPATIBILITY	Deore M515/525/575/415/465/475/495
LINING TYPE	Metallic pads

T4CHA000756



BP-DSM-2

All-purpose brake pads designed for disc brakes. They combine durability and convenience of use.

COMPATIBILITY	Deore M515/525/575/415/465/475/495
LINING TYPE	Semi-metallic pads

T4CHA000762



BP-DO-2

Great organic brake pads. They provide good modulation and quiet operation in all temperatures. Best choice for trekking and city bikes.

COMPATIBILITY	Deore M515/525/575/415/465/475/495
LINING TYPE	Organic pads

T4CHA000800



BP-U-1

Lightweight brake pads for road bicycles that ensure good braking performance in all weather conditions.

All-purpose

T4CHA000772



BP-V-3

One-piece lightweight brake pads designed for the V-brake type of brakes. They ensure good braking performance and quiet operation in any conditions.

All-purpose

T4CHA000810



BP-V-2

Classic V-brake pads that ensure good braking performance.

All-purpose

T4CHA000770



COMPONENTS

SPARE FRAME DROPOUTS

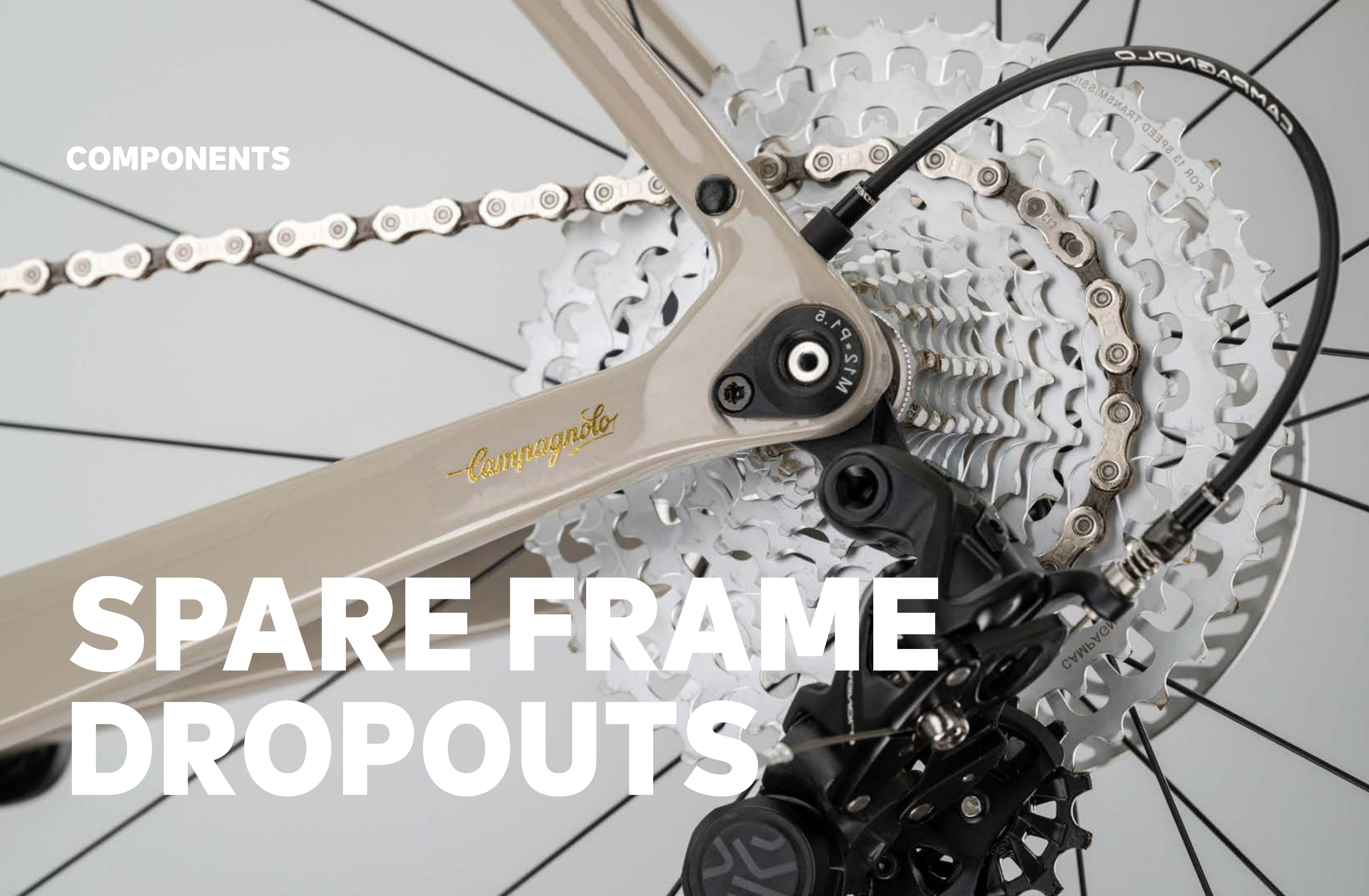



DP-10

Spare frame dropout.

YEAR / MODEL 2014	Vento 3.0- 4.0
YEAR / MODEL 2015	VENTO 5.0-7.0

T4CIN001414

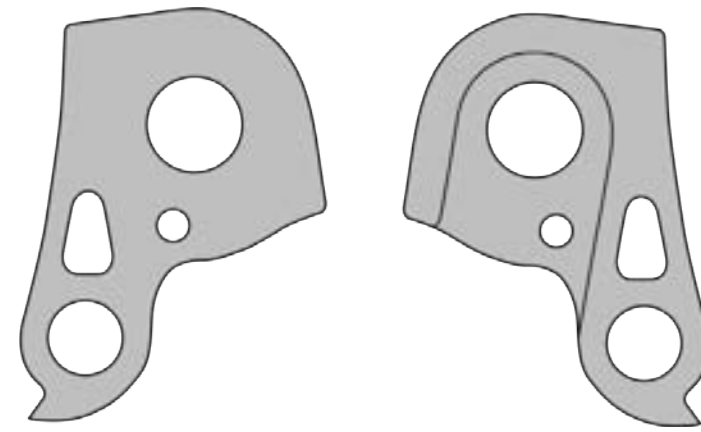

DP-15

Spare frame dropout.

YEAR / MODEL 2014	LEVEL B11, B+;
YEAR / MODEL 2015	LEVEL B11, B12, LEVEL B+

T4CIN001538



DP-29

Spare frame dropout.

YEAR / MODEL 2015	Vento 5.0- 6.0
YEAR / MODEL 2016	Vento 5.0- 9.0

T4CIN002016



DP-34

Spare frame dropout.

YEAR / MODEL 2014	BISETTE; SATINE; SILK; TRESSE; VENTO 1.0, 2.0
YEAR / MODEL 2015	BISETTE; SATINE; SILK; TRESSE; VENTO 1.0-4.0; PULSO 1.0, 2.0
YEAR / MODEL 2016/2017	VENTO 1.0-4.0; PULSO 1.0, 2.0
YEAR / MODEL 2018	VENTO Replica; PULSO 1.0, 2.0
YEAR / MODEL 2019/2020/2021	VENTO Jr 2.0

T4CHAKP000002

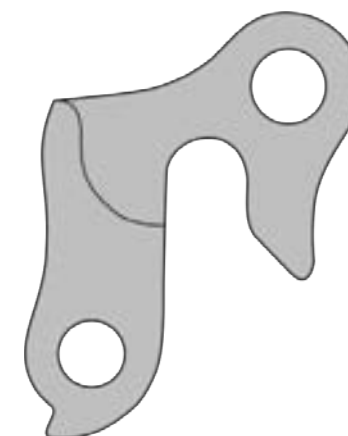

DP-35

Spare frame dropout.

YEAR / MODEL 2014	Hexagon X1,X2; LEA F1; TRANS ALP, PACIFIC, ARCTICA, SIBERIAN, ATLANTIC
YEAR / MODEL 2015/2016	Hexagon X1,X2,X2 DISK; LEA F1,F2; TRANS ALP, INDIA, ATLANTIC, PACIFIC, SIBERIAN
YEAR / MODEL 2017	Hexagon X0,X1,X2,X2 DISK; TRANS ALP, INDIA, ATLANTIC, PACIFIC, SIBERIAN
YEAR / MODEL 2018/2019/2020/2021	Hexagon 1.0; TRANS 1.0-3.0, 4.0-5.0

T4CHAKP000003

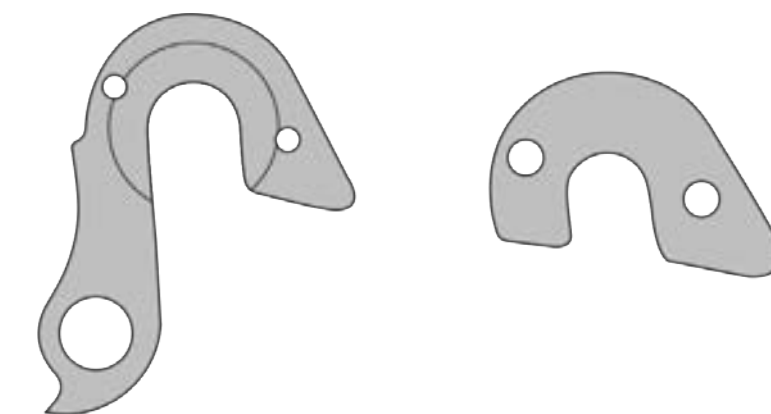

DP-37

Spare frame dropout.

YEAR / MODEL 2014	EVADO 3.0-5.0, 7.0; LEVEL A7,A8; B6,B7; R8
YEAR / MODEL 2015	EVADO 4.0-7.0; LEVEL B7,B8; R8
YEAR / MODEL 2016	EVADO 4.0-7.0; LEVEL B1-B6; R1-R6
YEAR / MODEL 2017	EVADO 4.0-7.0; LEVEL B1-B6; R1-R6
YEAR / MODEL 2018	EVADO 4.0-7.0; LEVEL 1.0-6.0; LEVEL JR TE
YEAR / MODEL 2019	EVADO 4.0-7.0; LEVEL 1.0-6.0; LEVEL BOOST 1.0
YEAR / MODEL 2020	EVADO 4.0-7.0; LEVEL 1.0-6.0; LEVEL BOOST 1.0; EVDO HYBRID
YEAR / MODEL 2021	EVADO 4.0-7.0, HYBRID; LEVEL 1.0-6.0; LEVEL BOOST 1.0

T4CHAKP000005



DP-38

Spare frame dropout.

YEAR / MODEL 2014/2015/2016	SPADE REPLICA
YEAR / MODEL 2017/2018	DUST REPLICA, DUST REPLICA PRO
YEAR / MODEL 2019/2020/2021	DUST JR 1.0-2.0

T4CHAKP000006

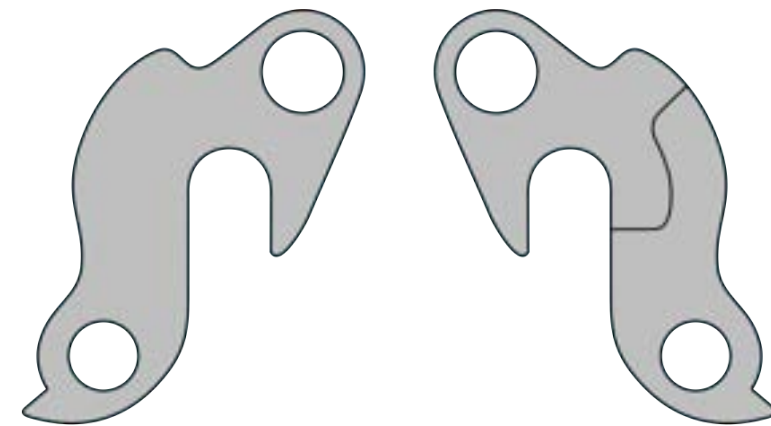

DP-44

Spare frame dropout.

YEAR / MODEL 2019	LEVEL WMN 10.0, 11.0; LEVEL 10.0, 11.0
-------------------	--

T4CHAKP0000039



DP-40

Spare frame dropout.

YEAR / MODEL 2017	LEVEL B CARBON
YEAR / MODEL 2018	LEVEL 10.0-13.0, TE
YEAR / MODEL 2019	EARTH 4.0, TE; LEVEL 11.0, 12.0-15.0, TE
YEAR / MODEL 2020	EARTH 4.0, TE; LEVEL 12.0-15.0, TE; LEVEL WMN 10.0, 11.0, TOKYO
YEAR / MODEL 2021	EARTH 4.0, TE; LEVEL 12.0-15.0, TE, TOKYO; LEVEL WMN 10.0, 11.0, TOKYO

T4CHAKP0000047



DP-45

Spare frame dropout.

YEAR / MODEL 2019	ESKER 2.0
YEAR / MODEL 2020	ESKER 2.0; PULSO 1.0 - 2.0
YEAR / MODEL 2022	ESKER 1.0-2.0
YEAR / MODEL 2023	ESKER 1.0

T4CHAKP0000040

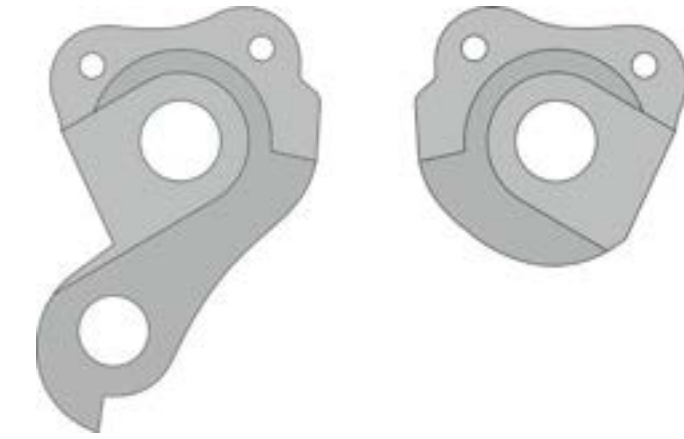

DP-43

Spare frame dropout.

YEAR / MODEL 2018*	LEVEL 7.0-9.0 (FRAME CODE UP TO Y7Lxxxxx);
YEAR / MODEL 2019*	LEVEL 7.0-9.0; LEVEL BOOST 2.0; LEVEL WMN 7.0, 8.0 (FRAME CODE STARTING FROM Y9Axx);
YEAR / MODEL 2020	LEVEL 7.0-9.0; LEA BOOST 3.0; LEVEL BOOST 2.0, 3.0; LEVEL WMN 7.0, 8.0;
YEAR / MODEL 2021	LEVEL 7.0-8.0; LEA BOOST 3.0, 4.0; LEVEL BOOST 1.0, 2.0, 3.0; LEVEL LADY 7.0, 8.0;
YEAR / MODEL 2022	LEVEL BOOST 1.0-3.0

* For frames with numbers up to Y7Lxxxxx and starting from Y9Axxxxx, available in the above-mentioned models, manufactured in the years as listed

T4CHAKP0000038

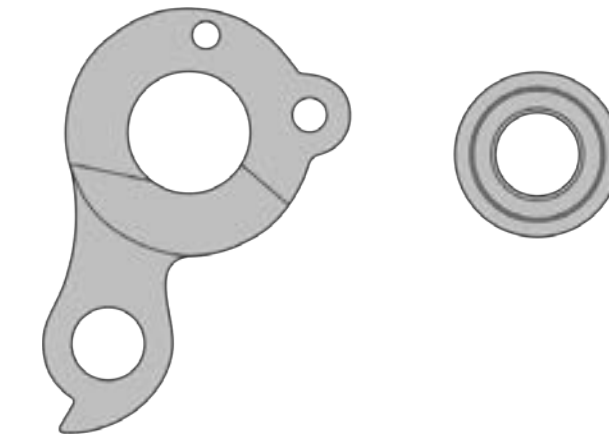

DP-46

Spare frame dropout.

YEAR / MODEL 2019	ESKER 6.0; VENTO CX 2.0, 4.0
YEAR / MODEL 2020	ESKER 6.0; VENTO CX 2.0, 4.0; VENTO 4.0
YEAR / MODEL 2021	ESKER 6.0; VENTO CX 2.0, 4.0; VENTO 4.0 DSC-5.0 DSC

T4CHAKP0000041

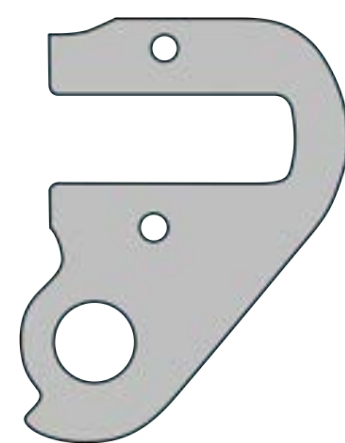

DP-49

Spare frame dropout.

YEAR / MODEL 2018/2019 VENTO TR 3.0, 4.0

T4CHAKP000054

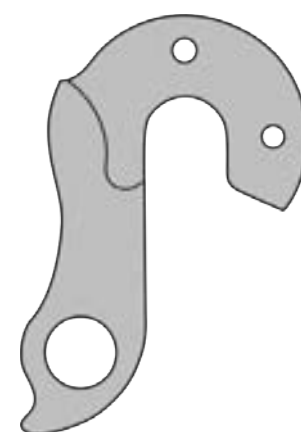

DP-50

Spare frame dropout.

YEAR / MODEL 2018/2019/2020 ESKER 4.0

T4CHAKP000056

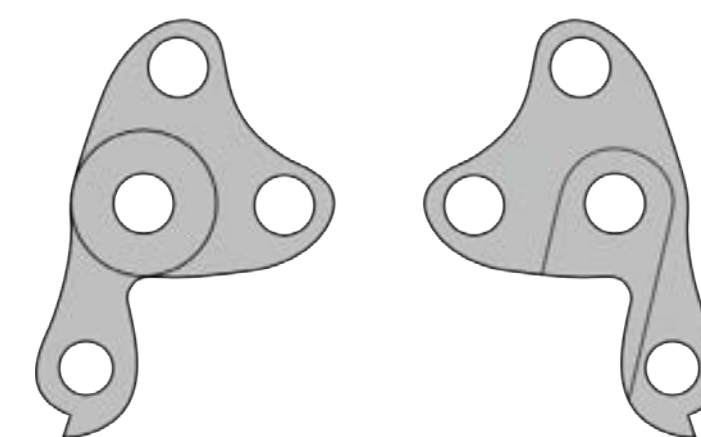

DP-51

Spare frame dropout.

YEAR / MODEL 2017/2019 SMOOTH TRAIL; PURE TRAIL

T4CHAKP000058

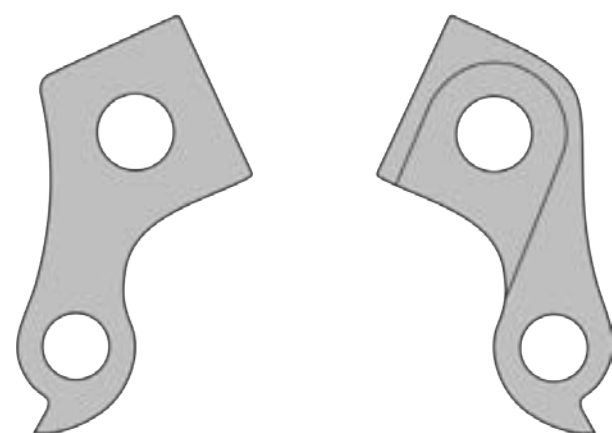

DP-54

Spare frame dropout.

YEAR / MODEL 2019/2020/2021 SOIL BOOST 1.0, 2.0

T4CHAKPS0000030



DP-19

Spare frame dropout.

YEAR / MODEL 2014 LEVEL B9, B10

YEAR / MODEL 2015 LEVEL B9, B10; R9, R10

T4CIN001413

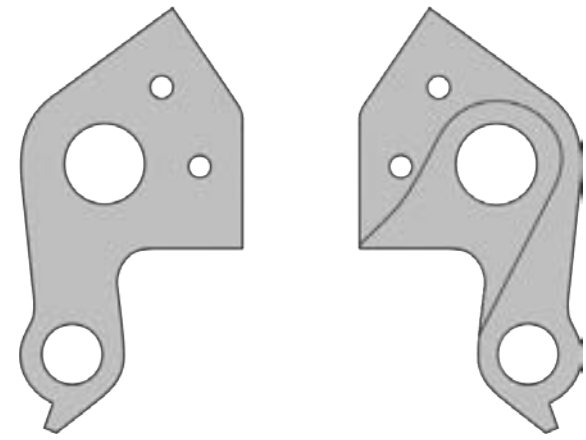

DP-56

Spare frame dropout.

YEAR / MODEL 2014	MOON 26 V1, V2, V3
YEAR / MODEL 2015	MOON 26 V1, V2, V3; MOON 27.5 Z1, Z2, Z3
YEAR / MODEL 2016	DUST 2.0-3.0; MOON 27.5 1.0-3.0, SOIL 27.5 1.0-3.0
YEAR / MODEL 2017	DUST 1.0-3.0; GRIST 1.0, 2.0; SOIL 27.5 1.0-3.0, EX
YEAR / MODEL 2018	DUST 1.0-3.0; GRIST 1.0, 2.0; SOIL 27.5 1.0-2.0; MOON 27.5 1.0-3.0
YEAR / MODEL 2019	DUST 1.0-2.0; GRIST 1.0, 2.0; SOIL 27.5 1.0-2.0; SOIL 29 1.0-3.0; MOON 27.5 1.0-3.0; MOON 29 1.0-3.0; EARTH 1.0-3.0
YEAR / MODEL 2020	DUST 1.0-2.0; SOIL 1.0-3.0; MOON 27.5 1.0-2.0; MOON 29 1.0-3.0; EARTH 1.0-3.0
YEAR / MODEL 2021	DUST 1.0-2.0; SOIL 1.0-3.0; MOON 27.5 1.0-2.0; MOON 29 1.0-3.0; EARTH 1.0-3.0

T4CHAKPS0000034

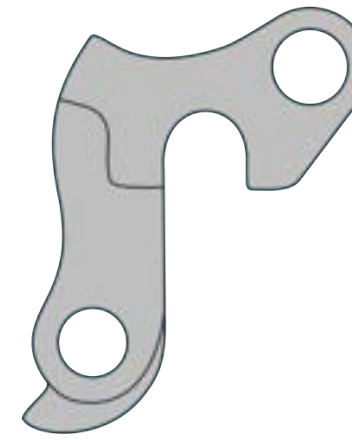

DP-57

Spare frame dropout.

YEAR / MODEL 2014	DIGGER; EVADO 1.0-2.0; HEXAGON X2 DISC, X5-X10; INZAI; LEA B2,B3; F2-F8, LEVEL A2-A6; B2-B6; LEVEL REPLICA; SETO; TRANS GLOBAL, SOLAR
YEAR / MODEL 2015	DIGGER; EVADO 1.0-3.0; HEXAGON X3-X6; R3-R8; INZAI; LEA F3,F4; R2,R3,R6 LEVEL A2-A4; B2-B4,B6; R2,R3,R6; LEVEL REPLICA; SETO; TRANS AFRICA, ARCTICA, GLOBAL, SOLAR
YEAR / MODEL 2016	EVADO 1.0-3.0; HEXAGON X3,X4,X6; R3-R8; INZAI; LEA F1-F4; R2,R4,R6; LEVEL REPLICA, REPLICA PRO; SETO; TRANS AFRICA, ARCTICA, GLOBAL, SOLAR
YEAR / MODEL 2017	EVADO 1.0-3.0; HEXAGON X3; R2-R8; B3,B5; INZAI; LEA F1-F4; R2,R6; LEVEL REPLICA, REPLICA PRO; SETO; TRANS AFRICA, ARCTICA, GLOBAL, SOLAR
YEAR / MODEL 2018	EVADO 1.0-3.0; HEXAGON 2.0-8.0; INZAI; LEA 1.0-6.0; LEVEL REPLICA, REPLICA PRO; SETO; TRANS 7.0, 8.0
YEAR / MODEL 2019	EVADO 1.0-3.0; JUNIOR; HEXAGON 2.0-8.0; INZAI; LEA 1.0-5.0; LEVEL JR 2.0, 3.0; SETO; TRANS 7.0, 8.0
YEAR / MODEL 2020	EVADO 1.0-3.0; JUNIOR; HEXAGON 2.0-8.0; BOOST 1.0; INZAI; LEA 1.0-5.0; LEVEL JR 2.0, 3.0, TOKYO; SETO; TRANS 7.0, 8.0; HYBRYD 2.0, 3.0, 5.0
YEAR / MODEL 2021	EVADO 1.0-3.0; JUNIOR; HEXAGON 2.0-8.0; BOOST 1.0; INZAI; LEA 1.0-5.0; LEVEL JR 2.0, 3.0, TOKYO; SETO; TRANS 7.0, 8.0; HYBRID ZZ

T4CHAKP0000001



DP-62

Spare frame dropout.

YEAR / MODEL 2017	TRANS HYBRID 3.0, 5.0
YEAR / MODEL 2018	EVADO 8.0-10.0; LEA 7.0, 8.0; TRANS 9.0-11.0
YEAR / MODEL 2019	TRANS HYBRID 2.0, 3.0, 5.0
YEAR / MODEL 2020	EVADO 8.0-10.0; LEA 6.0-8.0; BOOST 1.0; LEVEL JR TE; TRANS 9.0, 11.0; HYBRID 2.0, 3.0, 5.0
YEAR / MODEL 2021	EVADO 8.0-10.0, HYBRID 6.0; LEA 6.0-8.0; BOOST 1.0; LEVEL JR TE; TRANS 9.0, 11.0, HYBRID 2.0-6.0, HYBRID LS 3.0 5.0; CITY 1.0-3.0

T4CHAKP0000019

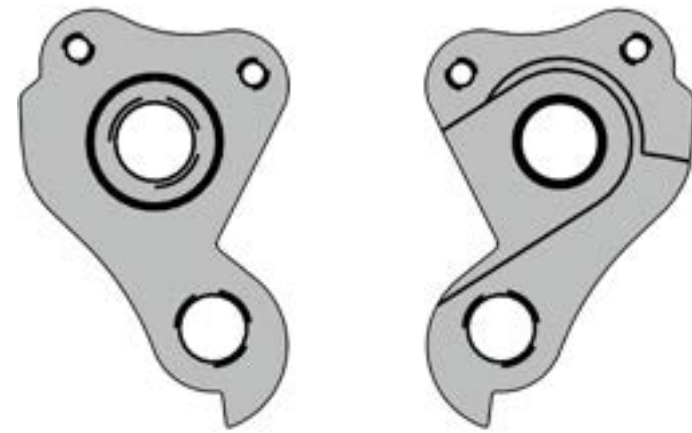

DP-64

Spare frame dropout.

YEAR / MODEL 2017	VENTO 7.0, 9.0
YEAR / MODEL 2018	LEVEL 7.0-9.0 (FRAME CODE UP TO Y7Lxxxx); VENTO 7.0, 8.0, TE
YEAR / MODEL 2019	LEVEL 7.0-9.0; LEVEL BOOST 2.0; LEVEL WMN 7.0, 8.0 (FRAME CODE STARTING FROM Y9Axx); VENTO 8.0, TE
YEAR / MODEL 2020	LEA BOOST 3.0; LEVEL BOOST 2.0,3.0; LEVEL WMN 7.0, 8.0; VENTO 8.0, TE
YEAR / MODEL 2021	LEVEL 7.0-9.0; LEA BOOST 3.0; LEVEL BOOST 2.0,3.0; LEVEL WMN 7.0, 8.0; VENTO 8.0, TE

T4CHAKP000059



DP-69

Spare frame dropout.

YEAR / MODEL 2018	VENTO 1.0-4.0
YEAR / MODEL 2019	PULSO 1.0, 2.0; VENTO 1.0-5.0
YEAR / MODEL 2020	PULSO 1.0, 2.0; VENTO 1.0-5.0
YEAR / MODEL 2021	VENTO 1.0-2.0,3.0,5.0

T4CHAKP000064

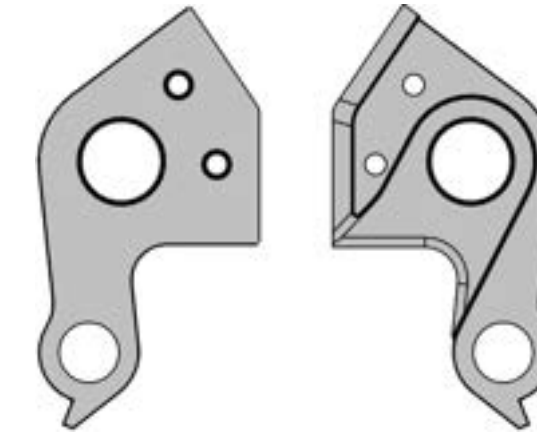

DP-70

Spare frame dropout.

YEAR / MODEL 2016	SOIL 1.0, 2.0, 3.0, EX; Dust 1.0,2.0,3.0; Grist 1.0,2.0
-------------------	---

T4CHAKP000065



DP-71

Spare frame dropout.

YEAR / MODEL 2019	ESKER 2.0
YEAR / MODEL 2020	ESKER 2.0
YEAR / MODEL 2021	ESKER 2.0; PULSO 1.0-2.0

T4CHAKP000066



DP-73

Spare frame dropout.

YEAR / MODEL 2017	VENTO 5.0, 6.0, 8.0
YEAR / MODEL 2018	VENTO 5.0, 6.0
YEAR / MODEL 2019	VENTO 5.0- 9.0
YEAR / MODEL 2020	VENTO 5.0-9.0
YEAR / MODEL 2021	VENTO 6.0-9.0

T4CHAKP000068



DP-75

Spare frame dropout.

YEAR / MODEL 2021	Level 1.0-6.0
-------------------	---------------

T4CHAKP000069



DP-77

Spare frame dropout.

YEAR / MODEL 2021 TRANS HYBRID LS2.0; HEXAGON BOOST 3.0

T4CHAKP000071



DP-76

Spare frame dropout.

YEAR / MODEL 2021 ESKER 7.0

T4CHAKP000070



DP-78

Spare frame dropout.

YEAR / MODEL 2021 FLEX HYBRID 1.0

T4CHAKP000072



DP-79

Spare frame dropout.

YEAR / MODEL 2018 LEVEL 7.0-9.0
YEAR / MODEL 2019 LEVEL 7.0-9.0; LEVEL BOOST 2.0; LEVEL WMN 7.0, 8.0
* For frames with numbers starting from Y8Axxxx, UP TO Y8Lxxxx, available in the above-mentioned models, manufactured in the years as listed

T4CHAKP000073



DP-80

Spare frame dropout.

YEAR / MODEL ESKER 4.0

T4CHAKP000074

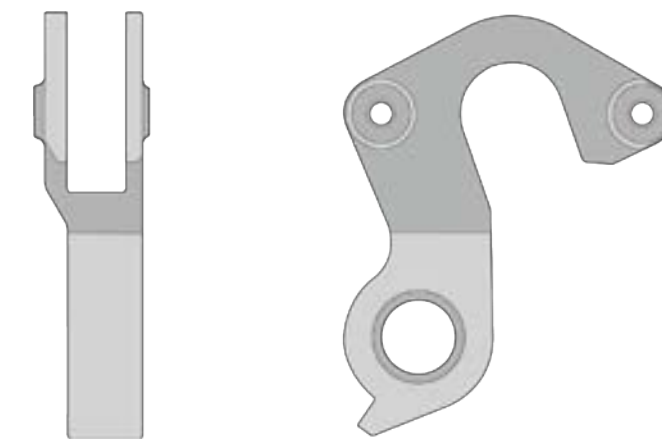

DP-81

Spare frame dropout.

YEAR / MODEL 2022 Vento 7.0 Carbon V/B

T4CHAKP000075



DP-82

Spare frame dropout.

YEAR / MODEL Inzai Hybrid 2.0

T4CHAKP000076



DP-83

Spare frame dropout.

YEAR / MODEL 2023 Trans 1.0-2.0; Evado 1.0-2.0; City 1.0-2.0

T4CHAKP000077



DP-84

Spare frame dropout.

YEAR / MODEL 2021 Level Jr. 2.0; Level Jr. 3.0; Level Jr. Tokyo
YEAR / MODEL 2022 Level Jr. 2.0; Level Jr. 3.0; Level Jr Tokyo

T4CHAKP000078



DP-85

Spare frame dropout.

YEAR / MODEL 2021 Inzai Hybrid 1.0; Lea 5.0; Trans 5.0-8.0; Trans Hybrid
YEAR / MODEL 2022 Inzai Hybrid 1.0; Lea 5.0; Trans 5.0-8.0; Trans Hybrid

T4CHAKP000079



DP-86

Spare frame dropout.

YEAR / MODEL 2020 Level 3.0-4.0;
YEAR / MODEL 2021 Evado 4.0; Level Boost 1.0
YEAR / MODEL 2022 Evado 4.0; Level Boost 1.0

T4CHAKP000080



DP-87

Spare frame dropout.

YEAR / MODEL 2022 Trans 1.0-4.0

T4CHAKP000081



DP-88

Spare frame dropout.

YEAR / MODEL 2021	Dust Jr. 1.0
YEAR / MODEL 2021	Dust Jr. 1.0

T4CHAKP000082

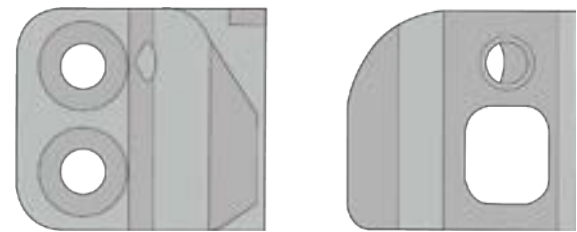

DP-90

Spare frame dropout.

YEAR / MODEL 2021	Earth 1.0-3.0
YEAR / MODEL 2022	Earth 1.0-2.0

T4CHAKP000084



DP-89

Spare frame dropout.

YEAR / MODEL 2020	Trans 9.0-10.0
YEAR / MODEL 2021	Lea 6.0, 8.0
YEAR / MODEL 2022	Evado 3.0-7.0; Trans 3.0-7.0; Lea 6.0, 8.0

T4CHAKP000083



DP-91

Spare frame dropout.

YEAR / MODEL 2024	Moon Boost 1.0
-------------------	----------------

T4CHAKP000085



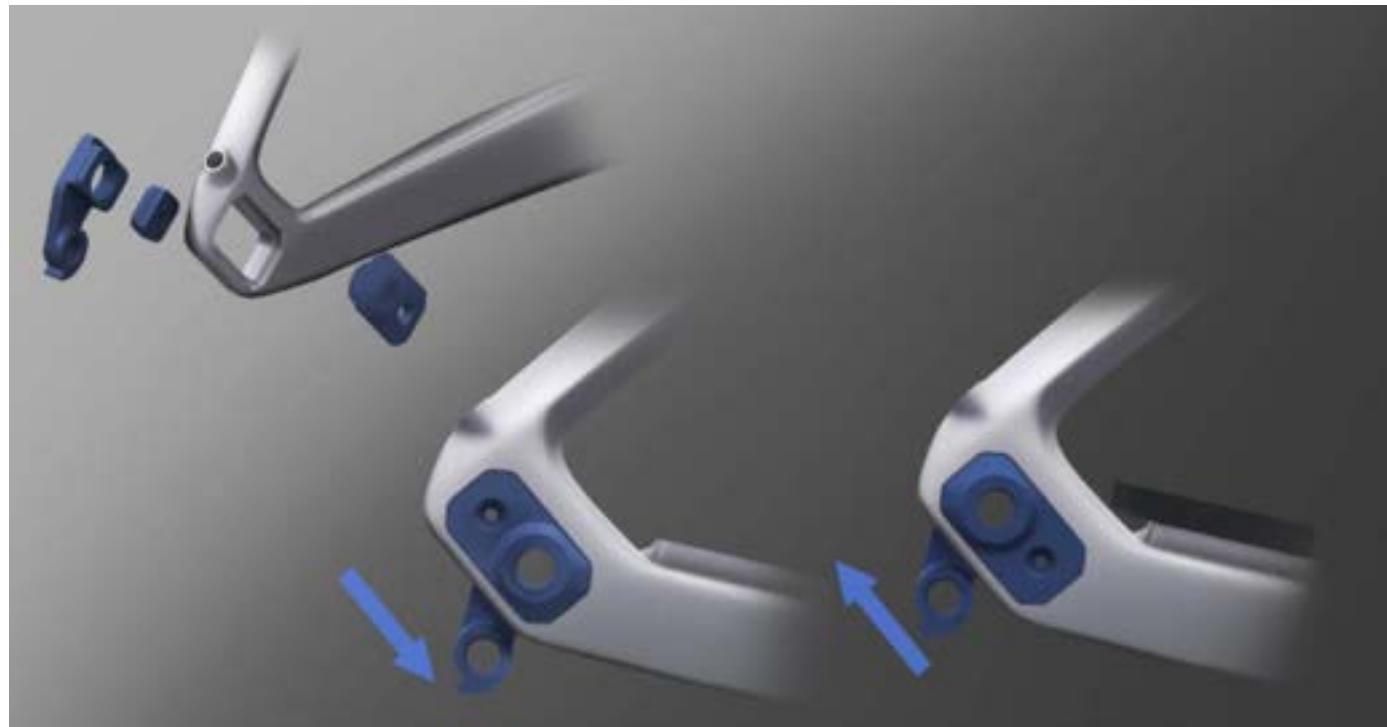

Thanks to the variable frame element - „Flip-chip“ it is possible to choose one of two geometries

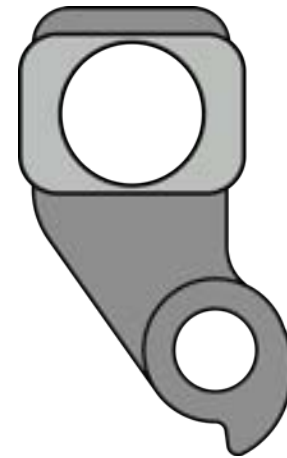

DP-92

Spare frame dropout.

YEAR / MODEL 2024 Esker RS 1.0 -3.0

T4CHAKP000086

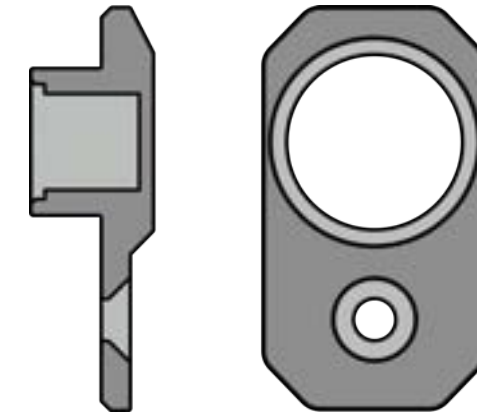

DP-93

Left FLIP-CHIP - A variable frame component for Esker RS, enabling the modification of its geometry.

YEAR / MODEL 2024 Esker RS 1.0 -3.0

T4CHAKP000087

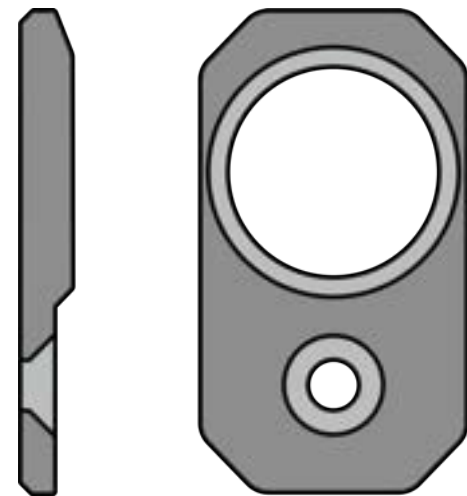

DP-94

Right FLIP-CHIP - The derailleur hanger and simultaneously a variable frame component for Esker RS, allowing for geometry adjustments.

YEAR / MODEL 2024 Esker RS 1.0 -3.0

T4CHAKP000088



DP-95

Left Dropout Adapter.

YEAR / MODEL 2024 Esker RS 1.0 -3.0

T4CHAKP000089

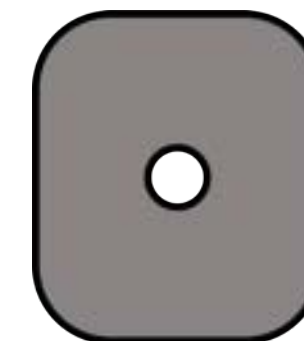

DP-96

Locking Wedge for FLIP-CHIP, present on both sides of the dropout.

YEAR / MODEL 2024 Esker RS 1.0 -3.0

T4CHAKP000090

PROTECTORS

PROTECTORS





CHAINSTAY PROTECTOR

Chainstay protection made of thick neoprene. Protects the rear fork tube from damage.

DIMENSIONS 105 x 115 mm

T4CIN000006



CHAINSTAY PROTECTOR LEVEL 10-TE

Chainstay protector for LEVEL 10.0, 11.0, 12.0, 13.0 14.0 15.0 and TE models. Manufactured with the use of the Counter Tech® technology to ensure perfect frame protection from chain damage.

DIMENSIONS 28.5 cm x 2.3 cm

T4CIN000005



NOTES

A grid of 20 columns and 25 rows of small black dots, intended for taking notes. The dots are arranged in a regular, repeating pattern across the page.



DUE TO THE COMPLEX NATURE OF THE MANUFACTURING PROCESS AND VARIABLE CONDITIONS OF COMPONENT DELIVERY, TECHNICAL SPECIFICATIONS ARE SUBJECT TO CHANGE DURING THE SEASON. SPECIFICATIONS PRESENTED HEREIN ARE VALID AS OF THE DATE OF PUBLICATION, THAT IS SEPTEMBER 2023. INFORMATION INCLUDED IN THE CATALOGUE SHALL NOT CONSTITUTE AN OFFER, AS DEFINED IN ART. 66 § 1 OF THE POLISH CIVIL CODE.

FOR THE LATEST OFFER, INCLUDING PRODUCT SPECIFICATIONS, VISIT WWW.KROSS.EU

VERSION 1.0



KROSS

YOU CAN DO EVERYTHING